

# INSTRUCTION SHEET

## MOTORCRAFT CARBURETOR — MODEL 4300A, D

### GENERAL EXPLODED VIEW

THE GENERAL DESIGN AND PARTS SHOWN WILL VARY TO INDIVIDUAL UNITS COVERED ON THIS INSTRUCTION SHEET

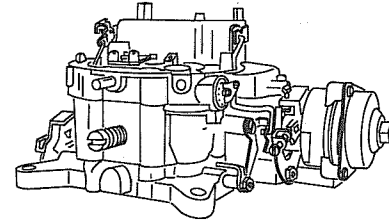

### DISASSEMBLY

USE EXPLODED VIEW AS A GUIDE. THE NUMERICAL SEQUENCE MAY GENERALLY BE FOLLOWED TO DISASSEMBLE UNIT FAR ENOUGH TO PERMIT CLEANING AND INSPECTION. NOTE: REMOVE STAKING FROM BOWL COVER FOR EASY REMOVAL OF POWER PISTON ASSEMBLY (26). 1968 AND LATER MODELS HAVE IDLE SCREW LIMITER CAPS. TO REMOVE CAPS INSTALL A SHEET METAL SCREW IN THE CENTER OF THE CAP AND TURN CLOCKWISE.

### NOMENCLATURE

REF. NO.	REF. NO.
1. SCREW - SECONDARY LOCKOUT LEVER	28. VALVE - PUMP AIR BLEED
2. LEVER - SECONDARY LOCKOUT	29. SCREW - AIR VALVE SPRING HOUSING CLAMP
3. RETAINERS (2) CHOKE ROD	30. CLAMP - AIR VALVE SPRING HOUSING
4. ROD - CHOKE	31. HOUSING - AIR VALVE SPRING
5. SEAL - CHOKE ROD DUST	32. SPRING - AIR VALVE 1966-68
6. RETAINER - PUMP ROD	33. BOWL COVER ASSEMBLY
7. ROD - PUMP	34. NEEDLE - PUMP DISCHARGE
8. SCREW (2) HOT IDLE COMPENSATOR VALVE	35. VALVE - POWER
9. VALVE - HOT IDLE COMPENSATOR	36. JETS (2) MAIN
10. GASKET - HOT IDLE COMPENSATOR VALVE	37. RETAINER - PUMP INTAKE BALL
11. SCREW - (1) BOWL COVER	38. BALL - PUMP INTAKE
12. SCREW - (10) BOWL COVER	39. IDLE AIR BYPASS SCREW
13. VALVE - IDLE VENT	40. SPRING - IDLE AIR BYPASS SCREW
14. PISTON & ROD ASSY. - AIR VALVE	41. SCREW (6) - THROTTLE BODY
15. WASHER - AIR VALVE ROD	42. BOWL ASSEMBLY - FLOAT
16. GASKET - BOWL COVER	43. GASKET - THROTTLE BODY
17. PIN - FLOAT HINGE	44. SCREW (3) - STAT RETAINER
18. FLOAT & LEVER ASSEMBLY	45. RETAINER - STAT
19. NEEDLE, SEAT & GASKET ASSY. PRI.	46. STAT COVER & SPRING ASSY.
20. NEEDLE, SEAT & GASKET ASSY. SEC.	47. GASKET - STAT COVER
21. RETAINER - PUMP LEVER PIN	48. SCREW & LOCKWASHER - CHOKE PISTON & LINK
22. PIN - PUMP LEVER	49. PISTON & LINK - CHOKE
23. LEVER - PUMP	50. SHAFT & LEVER - CHOKE HOUSING
24. LEVER - IDLE VENT VALVE	51. NEEDLES - IDLE ADJUSTING
25. PUMP ASSEMBLY	52. SPRINGS - IDLE ADJ. NEEDLES
26. POWER PISTON ASSEMBLY	53. THROTTLE BODY ASSEMBLY
27. RETAINER - PUMP AIR BLEED VALVE	

NOTE 1: 1969 & LATER-SECONDARY AIR VALVE SPRING. NO ADJUSTMENT REQUIRED.  
NOTE 2: REF. NO. 27 & 28 NOT REQUIRED AFTER 1971.

### CLEANING

CLEANING MUST BE DONE WITH CARBURETOR DISASSEMBLED. SOAK PARTS LONG ENOUGH TO SOFTEN AND REMOVE ALL FOREIGN MATERIAL. USE (1) A CARBURETOR CLEANING SOLVENT, (2) LACQUER THINNER OR (3) DENATURED ALCOHOL. MAKE CERTAIN THE THROTTLE BORES ARE FREE OF ALL CARBON AND VARNISH DEPOSITS. RINSE OFF IN SUITABLE SOLVENT. BLOW OUT ALL PASSAGES IN CASTINGS WITH COMPRESSED AIR AND CHECK CAREFULLY TO INSURE THOROUGH CLEANING OF OBSCURE AREAS. CAUTION: DO NOT SOAK RUBBER PARTS OR FLOAT (18) IN SOLVENT.

### REASSEMBLY

REASSEMBLE IN REVERSE ORDER OF DISASSEMBLY. NOTE SPECIAL INSTRUCTIONS AND FOLLOW NUMERICAL OUTLINE IN MAKING ADJUSTMENTS. (SEE ADJUSTMENTS.)

### SPECIAL INSTRUCTIONS

POWER VALVE (35) - IF A NYLON POWER VALVE SPRING RETAINER IS USED, REPLACE WITH RETAINER IN KIT. DO NOT REPLACE IF RETAINER ON VALVE IS METAL.

FLOAT HINGE PIN INSTALLATION (17) - INSTALL SO HEAD OF PIN IS ON PUMP SIDE.

POWER PISTON INSTALLATION - LIGHTLY STAKE CASTING AROUND WASHER.

PUMP AIR BLEED VALVE RETAINER (27) - INSTALL FLUSH WITH BOWL COVER.

BOWL COVER SCREW (11) SPECIAL - INSTALL WHERE SHOWN ON EXPLODED VIEW.

AIR VALVE SPRING (32) INSTALLATION - INSTALL OPEN END OF SPRING HOOK TO THE LEFT AT BOTTOM OF HOUSING CAVITY.

IDLE ADJUSTING NEEDLES (51) - TURN EACH NEEDLE INTO SEAT LIGHTLY AND THEN BACK OUT 1 1/2 TURNS. (DO NOT INSTALL IDLE LIMITER CAPS AT THIS TIME.)

IDLE AIR BYPASS SCREW (39) - TURN IN UNTIL SEATED, THEN BACK OUT 3 1/2 TURNS.

STAT COVER INSTALLATION (46) - BE SURE STAT SPRING IS PLACED IN SLOT OF VACUUM PISTON LEVER (49).

DASHPOT BRACKET IF USED - BE SURE TO INSTALL IT BEFORE INSTALLING THROTTLE BODY TO FUEL BOWL.

CARBURETOR HOLD DOWN NUTS. - TORQUE TO 14 FT. LBS.

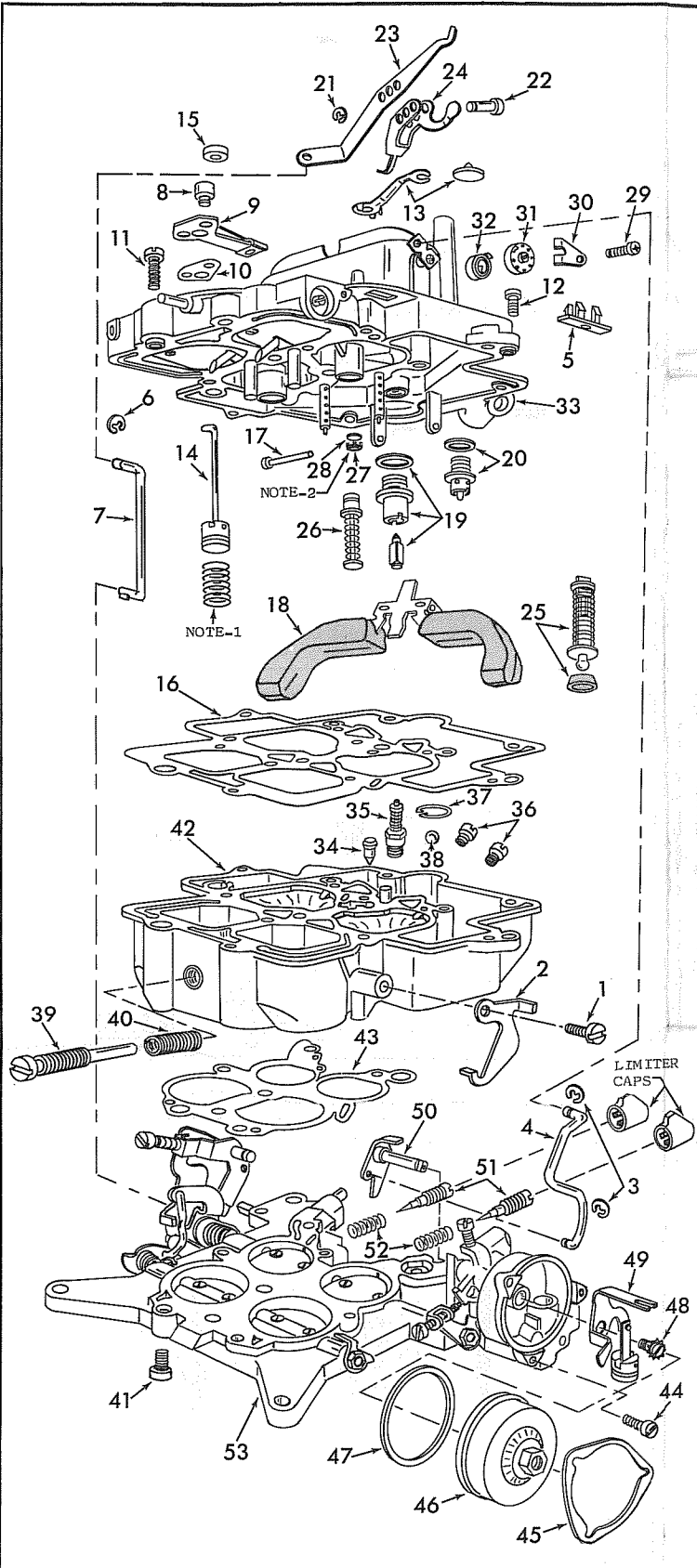

# ADJUSTMENTS

**STEP ONE  
PRIMARY NEEDLE-SEAT**

① FLOAT GAUGE PLACED IN SCREW HOLE, MEASURE FROM BOWL COVER TO TOP OF EACH FLOAT. (SEE DATA TABLE FOR MEASUREMENT.)

② TO ADJUST BEND PRIMARY FLOAT TAB.

**CAUTION**  
DO NOT EXERT PRESSURE ON RESILIENT NEEDLE VALVE (PRIMARY VALVE).

**STEP TWO  
SECONDARY NEEDLE-SEAT**

② TO ADJUST BEND SECONDARY FLOAT TAB.

① FLOAT HELD IN CLOSED POSITION, MEASURE BETWEEN SECONDARY FLOAT TAB AND SECONDARY NEEDLE. (SEE DATA TABLE FOR MEASUREMENT.)

FLOAT LEVEL ADJUSTMENTS

Fig. 1

NO. 1 LEAN    NO. 2 STD.    NO. 3 RICH

1966-67 INSTALL PUMP PIVOT PIN IN PROPER HOLE. TO ADJUST DISCONNECT PUMP ROD AND CHANGE PIVOT PIN.

1968 & LATER INSTALL PUMP PIVOT PIN IN PROPER HOLE. THROTTLE VALVES HELD COMPLETELY CLOSED. MEASURE FROM TOP OF PUMP PLUNGER TO BOWL COVER. (SEE DATA TABLE FOR MEASUREMENT.)

1968 & LATER TO ADJUST BEND ROD.

PUMP ADJUSTMENT

Fig. 2

② MEASURE BETWEEN LOWER SIDE OF IDLE VENT VALVE AND VALVE SEAT.

③ TO ADJUST BEND VENT VALVE LEVER.

① THROTTLE VALVES HELD COMPLETELY CLOSED.

1966-69  
IDLE VENT VALVE ADJUSTMENT

Fig. 3

④ 1970 TO ADJUST LOOSEN HEX HEAD SCREW (LEFT HAND THREAD) ON CHOKE SHAFT THEN ROTATE LEVER.

③ MEASURE DISTANCE BETWEEN LOWER EDGE OF CHOKE VALVE AND AIR HORN WALL. (SEE DATA TABLE FOR MEASUREMENT.)

② INSERT BENT EDGE OF GAUGE BETWEEN PISTON SLOT AND UPPER EDGE OF RIGHT HAND SLOT IN CHOKE HOUSING. ROTATE CHOKE LEVER COUNTERCLOCKWISE UNTIL GAUGE IS HELD SNUG IN PISTON SLOT. HOLD IN PLACE.

④ TO ADJUST BEND LEVER.

① OPEN THROTTLE (1/2 OPEN)

GAUGE - MAKE FROM PAPER CLIP .036.

1/8" BEND

CHOKE VALVE PULLDOWN ADJUSTMENT

Fig. 4

③ MEASURE DISTANCE BETWEEN LOWER EDGE OF CHOKE VALVE AND AIR HORN WALL. (SEE DATA TABLE FOR MEASUREMENT.)

④ TO ADJUST TURN ADJUSTING SCREW.

① TEMPORARILY TURN STAT COVER 90° RICH BEYOND INDEX.

② PLACE FAST IDLE SCREW OR LEVER TANG ON SECOND STEP OF FAST IDLE CAM NEXT TO HIGH STEP.

FAST IDLE CAM LINKAGE ADJUSTMENT

Fig. 5

9/64"    19/64"

② 1966-67 HOLD CHOKE VALVE TOWARD CLOSED POSITION. MEASURE BETWEEN UPPER EDGE OF CHOKE VALVE AND AIR HORN WALL.

② 1968 & LATER HOLD CHOKE VALVE TOWARD CLOSED POSITION. MEASURE BETWEEN LOWER EDGE OF CHOKE VALVE AND AIR HORN WALL.

③ TO ADJUST BEND TANG.

① THROTTLE HELD WIDE OPEN.

CHOKE UNLOADER ADJUSTMENT

Fig. 6

② HOLD AIR VALVE IN CLOSED POSITION.

① LOOSEN CLAMP SCREW. LET HOUSING ROTATE TO NO LOAD POSITION.

③ SCRIBE REFERENCE MARK, ROTATE NYLON SPRING HOUSING COUNTERCLOCKWISE PROPER NUMBER OF KNOBS (SEE TABLE). TIGHTEN CLAMP SCREW.

289" ENG. S/T	5 KNOBS
289" ENG. A/T	4 KNOBS
390" ENG.	7 KNOBS
410"-428" ENG.	8 KNOBS

1966-68  
SECONDARY AIR VALVE ADJUSTMENT

Fig. 7

ROTATE STAT COVER AGAINST SPRING TENSION, SET MARK ON COVER TO SPECIFIED POINT ON CHOKE HOUSING. (SEE DATA TABLE FOR MEASUREMENT.)

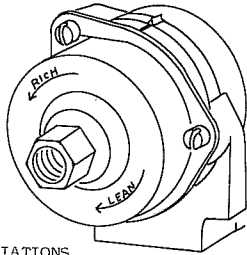

ALLOWABLE VARIATIONS  
2 NOTCHES EITHER WAY  
FROM INITIAL SETTING.

AUTOMATIC CHOKE SETTING

Fig. 8

WITH CHOKE PLATE FULLY CLOSED, BACK OFF THE ADJUSTING SLEEVE LOCKNUT UNTIL IT IS CLEAR OF THE ADJUSTING SLEEVE, TURN ADJUSTING SLEEVE INWARD UNTIL THE CHOKE PLATE JUST BEGINS TO MOVE, SCRIBE A MARK ON THE UPPER FLAT OF THE SLEEVE, THEN BACK OFF THE SLEEVE ONE COMPLETE TURN AND TIGHTEN LOCKNUT FIRMLY AGAINST SLEEVE. **NOTE:** DO NOT TURN THE DIAPHRAGM STEM.

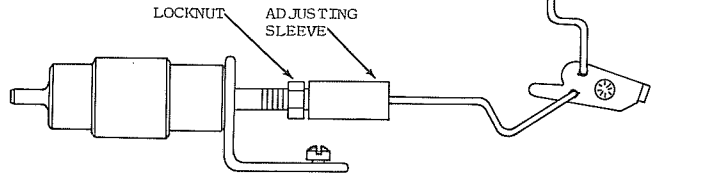

STAGE CHOKE CONTROL ADJUSTMENT

Fig. 9

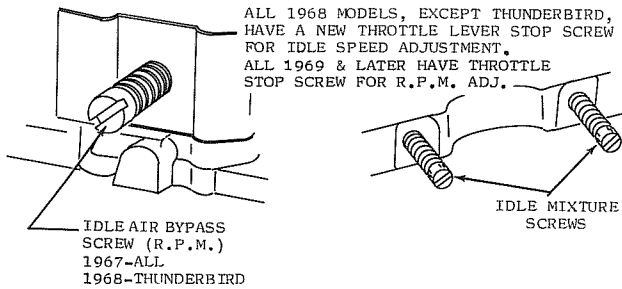

ALL 1968 MODELS, EXCEPT THUNDERBIRD, HAVE A NEW THROTTLE LEVER STOP SCREW FOR IDLE SPEED ADJUSTMENT. ALL 1969 & LATER HAVE THROTTLE STOP SCREW FOR R.P.M. ADJ.

IDLE AIR BYPASS SCREW (R.P.M.)  
1967-ALL  
1968-THUNDERBIRD

IDLE MIXTURE SCREWS

USE FACTORY CAR MANUAL PROCEDURE FOR SETTING SLOW IDLE IF AVAILABLE, AND SPECIFICATIONS LISTED ON ENGINE DECAL.

SUPPLEMENT

SLOW IDLE ADJUSTMENT PROCEDURE WITH AND WITHOUT THROTTLE SOLENOID POSITIONER.

1. SET IGNITION TIMING PER CAR FACTORY SPECIFICATIONS.
2. ENGINE AT OPERATING TEMPERATURE, CHOKE FULLY OPEN
  - A. AIR CLEANER INSTALLED.
  - B. HEADLIGHTS ON HIGH BEAM.
  - C. AUTOMATIC TRANSMISSION IN DRIVE.
  - D. HOT IDLE COMPENSATOR VALVE CLOSED.
  - E. VACUUM LINE DISCONNECTED FROM VACUUM RELEASE PARKING BRAKE, AND LINE PLUGGED.
  - F. THERMACTOR EQUIPPED CARS: THERMAL SENSING VALVE VACUUM LINE DISCONNECTED AND PLUGGED.
  - G. AIR CONDITIONER ON, 1967-69 MODELS ONLY.
3. ADJUST THROTTLE STOP SCREW TO SPECIFIED IDLE SPEED R.P.M. USING A TACHOMETER.
 

**NOTE:** WHEN USED ADJUST SOLENOID THROTTLE POSITIONER TO SPECIFIED IDLE SPEED (SOLENOID LEAD MUST BE CONNECTED SO SOLENOID WILL BE ENERGIZED.)
4. ADJUST IDLE MIXTURE NEEDLES TO OBTAIN THE HIGHEST R.P.M. AT THE LEANEST BEST IDLE SETTING.
5. READJUST IDLE SPEED IF NECESSARY.
 

**NOTE:** DISCONNECT SOLENOID THROTTLE POSITIONER AT BULLET CONNECTION THEN ADJUST THROTTLE STOP SCREW FOR LOWER R.P.M. WITH AUTOMATIC OR MANUAL TRANSMISSION IN NEUTRAL. CONNECT SOLENOID, OPEN THROTTLE AND RELEASE, RECHECK HIGHER IDLE SPEED.
6. AFTER COMPLETING THE ABOVE, INSTALL THE LIMITER CAPS ON THE IDLE MIXTURE NEEDLES. **NOTE:** TO AID INSTALLATION, IT MAY BE NECESSARY TO SOAK CAPS IN BOILING HOT WATER FOR A FEW MINUTES.
  - A. PLACE THE CAP ON THE MIXTURE NEEDLE HEAD WITH THE TAB IN THE EXTREME COUNTERCLOCKWISE POSITION AGAINST THE LIMITER STOP.
  - B. SEAT THE LIMITER CAP ON THE MIXTURE NEEDLE HEAD BY PRESSING FIRMLY ON THE CAP.

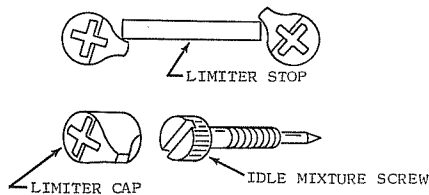

SLOW IDLE SPEED ADJUSTMENT

Fig. 10

ADJUST SLOW IDLE, THEN PLACE FAST IDLE SCREW OR LEVER TANG ON SECOND STEP OF FAST IDLE CAM AND ADJUST FAST IDLE SCREW TO PROPER R.P.M.

**NOTE:** ELECTRONIC SPARK CONTROL OR TRANSMISSION REGULATED SPARK SYSTEM WITH AMBIENT TEMPERATURE ABOVE 55°F. CONNECT A VACUUM LINE DIRECTLY FROM CARBURETOR SPARK PORT TO ADVANCE SIDE OF DISTRIBUTOR (i.e. BY-PASSING THE SPARK CONTROL SYSTEM). DISCONNECT THE VACUUM SUPPLY LINE TO THE EGR VALVE AND PLUG THE LINE.

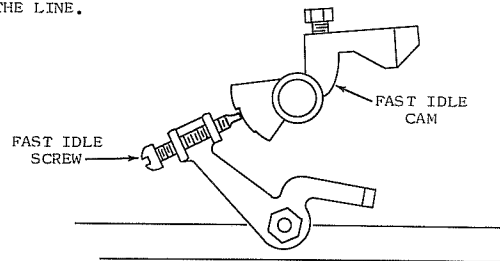

FAST IDLE ADJUSTMENT

Fig. 11

- 1968 FORD MTRS. 1/16"-7/64"
- 1969 FORD MTRS. 3/32"-3/90" ENG. GT 1/8"
- 1970 FORD MTRS. 5/64"-7/64"
- AMERICAN MTRS. 1/8" A/T 1/16" S/T
- 1971 FORD MTRS. 1/16" 429" ENG. 7/64" 460" ENG.
- AMERICAN MTRS. 1/8" A/T 1/16" S/T
- 1972-73 AMERICAN MTRS. 9/64"

- ① ADJUST SLOW IDLE
- ② DEPRESS PLUNGER STEM AND MEASURE DISTANCE BETWEEN END OF STEM AND THROTTLE ARM.
- ③ LOOSEN LOCKNUT AND TURN UNIT TO ADJUST. TIGHTEN NUT.

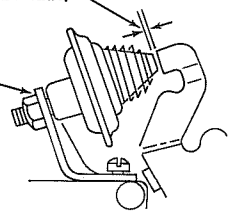

(ON CAR)  
DASHPOT ADJUSTMENT

Fig. 12