

2008 SMD Film Capacitors Catalogue

CONTENTS

	page
Short guide to main applications	2
Product coding and packaging	3
PEN and PPS dielectrics typical temperature graphs	4
PEN and PPS dielectrics typical frequency graphs.....	5
LDE series - PEN dielectric RoHS 6	
Low voltage (50 - 63 - 100 - 250 V _{DC}) size table	6 and 7
High voltage (400 - 630 - 1000 V _{DC}) size table.....	8
Technical data	9
Maximum V _{RMS} and I _{RMS} vs. frequency graphs.....	10 and 11
LDB series - PPS dielectric RoHS 6	
16 - 50 V _{DC} size table	12
Technical data	13
Soldering recommendations and cautions	14 and 15
Production process basic suggestions	16

Although the text of this publication is accurate to the best of our knowledge when printed, we reserve the right to make changes without prior notice.

Short guide to main applications

	Device	Application	Arcotronics SMD Film proposal	Main Competitors	SMD Film advantages
TELECOM	Mobile phone	A/D converter	LDB series	Ceramic NP0	- Low Lock-up time - Narrow tolerance - No cracking
		PLL filtering			
	Bluetooth ®	PLL filtering	LDB series	Ceramic NP0	
	Modem	DMT modulation / demodulation	LDE / LDB series	Ceramic NP0	
	Base station	Filtering	LDE / LDB series	Ceramic X7R	- High stability vs. frequency and temperature - High reliability - No cracking
	Line Card	Input filtering	LDE series	Ceramic NP0	
Splitter	Filtering	LDE series	Ceramic X7R		
AUTOMOTIVE	Wiper	Noise suppression	LDE series	Ceramic X7R	- High stability vs. frequency and temperature - High reliability - Low ESR - No cracking
	Driver information & car entertainment	Filtering, timing, coupling and decoupling	LDE series	Ceramic X7R	
	Tire pressure monitoring system	Resonant circuit	LDE series	Ceramic X7R	
CONSUMER	DC/DC converter	Input / output filtering	LDE series	Ceramic X7R	- High reliability - Low ESR - No cracking
	LCD Monitor	Inverter unit	LDE series	Ceramic X7R	- High stability vs. frequency and temperature - High reliability - No cracking
	DVD player	Filtering	LDB series	Ceramic NP0	
	PDA	Inverter unit	LDB series	Ceramic NP0	
	Hi-Fi systems	Filtering	LDE / LDB series	Ceramic X7R	

Description:

- Non-encapsulated construction
- Stacked technology
- Metallized PEN (**P**oly**E**thylene **N**aphtalate) in LDE series
- Metallized PPS (**P**oly**P**henylene **S**ulfide) in LDB series
- RoHS 6 compliant (no hazardous materials)

Features:

- Excellent stability vs. temperature, frequency and time
- Self-healing
- High reliability
- Low ESR (**E**quivalent **S**eries **R**esistance)
- Typical failure mode at the end of life: open circuit
- No piezoelectric effect
- No cracking
- No VCC (**V**oltage **C**oefficient of **C**apacitance)

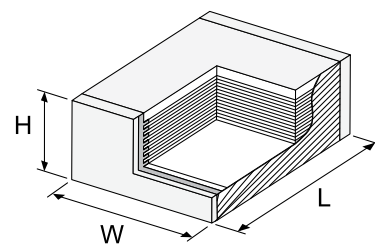

SMD Film Capacitors are complementary to MLCCs for professional applications.

Product coding

LDE series - RoHS 6

The part number is composed of 15 digits:

1	2	3	4	5	6	7	8	9	10	11	12	13	14	15
L	D	E	-	-	-	-	-	-	A	-	-	-	-	0

Digit 1 to 3 Series code.

Digit 4 D.C. rated voltage: (V_R)
 C = 50 V_{DC} D = 63 V_{DC} E = 100 V_{DC}
 I = 250 V_{DC} M = 400 V_{DC} P = 630 V_{DC}
 Q = 1000 V_{DC} (new version)

Digit 5 Size code (customized sizes available upon request)

12.06	12.10	18.12	22.20	28.24	40.30	50.40	60.54
A	B	C	D	E	F	G	H

Digit 6 to 9 Capacitance value
 Digits 7 - 8 - 9 indicate the first three numbers of the capacitance value, digit 6 indicates the number of zeros that must be added to obtain the rated capacitance in pF.

Digit 10 Capacitance tolerance
 Standard: K = $\pm 10\%$ M = $\pm 20\%$
 (J = $\pm 5\%$ available upon request and review of project/application)

Digit 11 Dielectric code
 A = PEN

Digit 12 Version
 5 = standard 0 = miniature A to Z = special

Digit 13 Packaging
 N = taped A to Z = special

Digit 14 Internal use

Digit 15 0 (used in LDE RoHS 6 series only)

LDB series - RoHS 6

The part number is composed of 14 digits:

1	2	3	4	5	6	7	8	9	10	11	12	13	14
L	D	B	-	-	-	-	-	-	-	C	-	-	-

Digit 1 to 3 Series code.

Digit 4 D.C. rated voltage: (V_R)
 A = 16 V_{DC}
 C = 50 V_{DC}

Digit 5 Size code

12.06	12.10	18.12
A	B	C

Digit 6 to 9 Capacitance value
 Digits 7 - 8 - 9 indicate the first three numbers of the capacitance value, digit 6 indicates the number of zeros that must be added to obtain the rated capacitance in pF.

Digit 10 Capacitance tolerance
 G = $\pm 2\%$ J = $\pm 5\%$

Digit 11 Dielectric code
 C = PPS

Digit 12 Version
 5 = standard A to Z = special

Digit 13 Packaging
 N = taped A to Z = special

Digit 14 Internal use

Product packaging

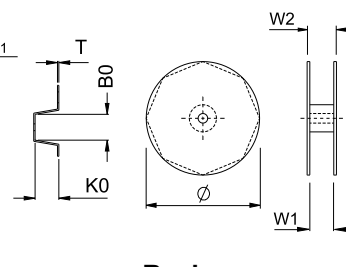
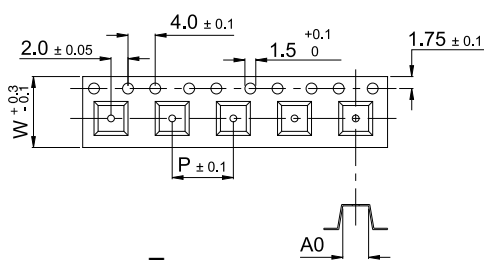
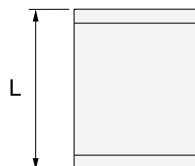

SMD Film Capacitor (top view)

Tape

Reel

Size code	Carrier tape code	Carrier tape dimensions					Reel dimensions			Packaging quantities (pcs per reel)	
		A0 [mm]	B0 [mm]	K0 [mm]	W [mm]	P [mm]	T [µm]	Ø [mm]	W1 [mm]		W2 [mm]
12.06	-	2.00	3.80	1.30	8	4	250	180	8	12	3000
12.10	-	3.00	3.80	2.10	8	4	250	180	8	12	2250
18.12	a	3.80	5.30	2.00	12	8	300	330	12	16	4000
	b	3.90	5.20	2.60							3000
22.20	a	5.50	6.50	2.90	12	8	250	330	12	16	3000
	b			3.80							2250
	c			4.90							1750
28.24	a	6.60	7.90	3.80	16	8	300	330	16	20	2250
	b			4.60							1750
	c			5.50							1500
40.30	a	8.60	11.00	3.80	16	12	300	330	16	20	1500
	b			4.60							1250
	c			5.80							1000
50.40	a	10.90	13.50	3.80	24	12	250	330	24	28	1500
	b	10.90		4.70							1250
	c	11.00		5.90							1000
60.54	a	14.40	16.00	4.30	24	16	300	330	24	28	1000
	b			5.10							750
	c			5.80							750

In accordance with IEC 60286-3

Materials:

- carrier tape: antistatic material
- cover tape: polyester + polythene
- reel: recyclable polystyrene

All parts in reels are packed in hermetically sealed **Moisture Barrier Bag (MBB) Class 1**.

PEN and PPS dielectrics typical temperature graphs

PEN

Capacitance vs. temperature

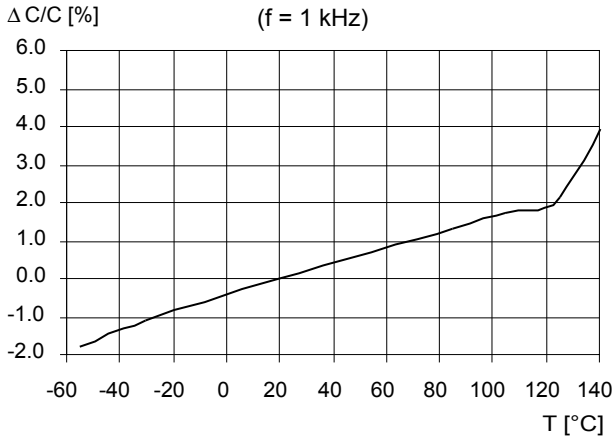

PPS

Capacitance vs. temperature

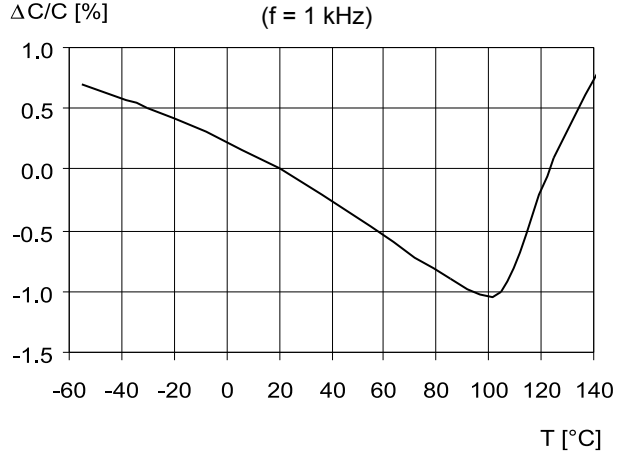

Dissipation factor vs. temperature

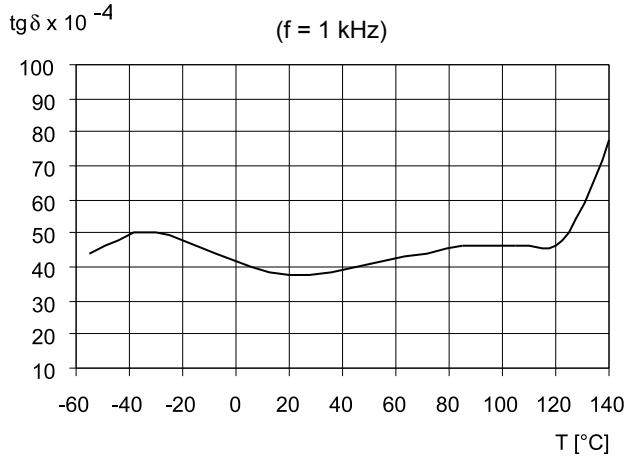

Dissipation factor vs. temperature

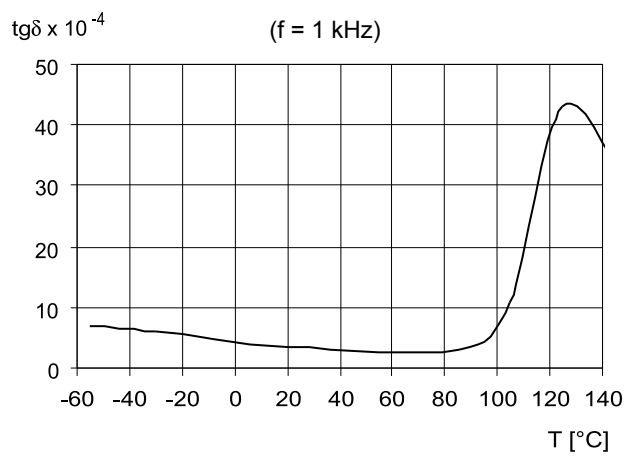

Insulation resistance vs. temperature

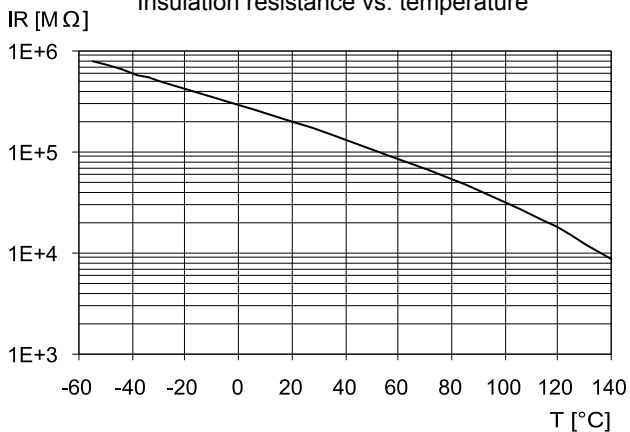

Insulation resistance vs. temperature

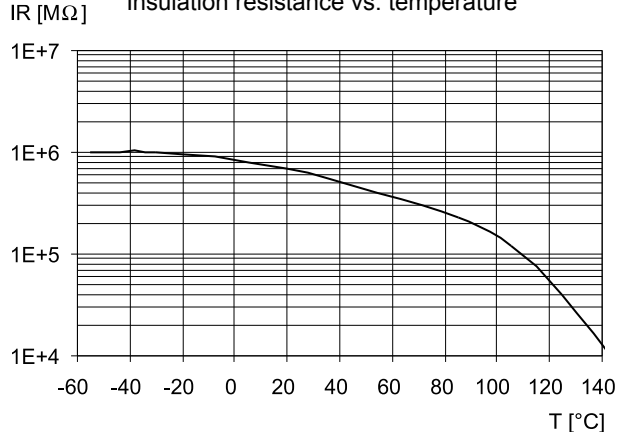

PEN and PPS dielectrics typical frequency graphs

PEN

PPS

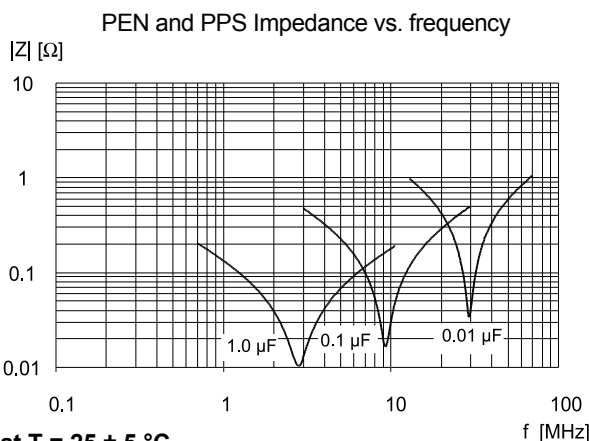
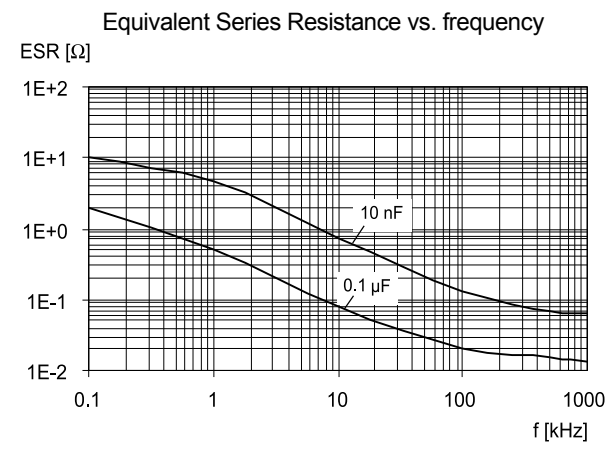
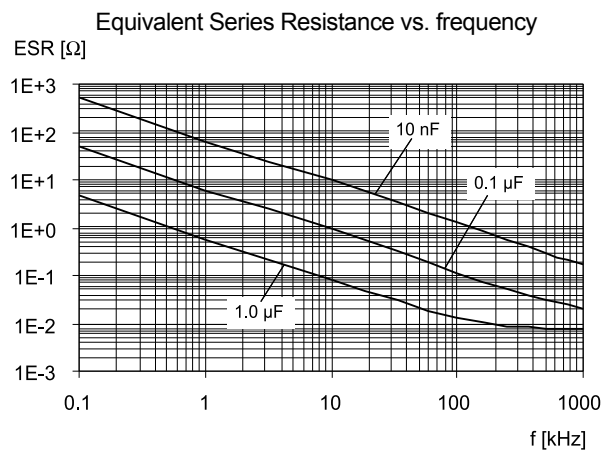
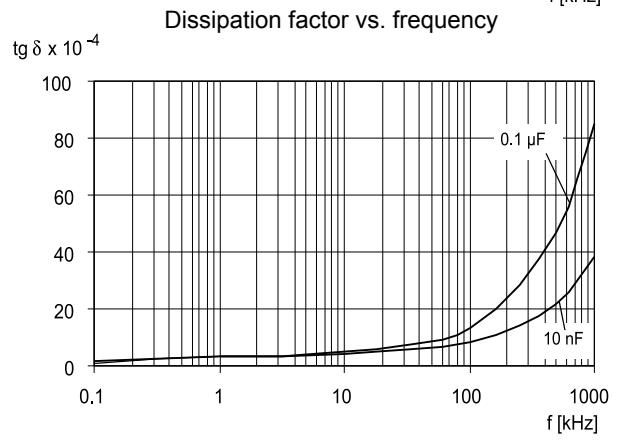
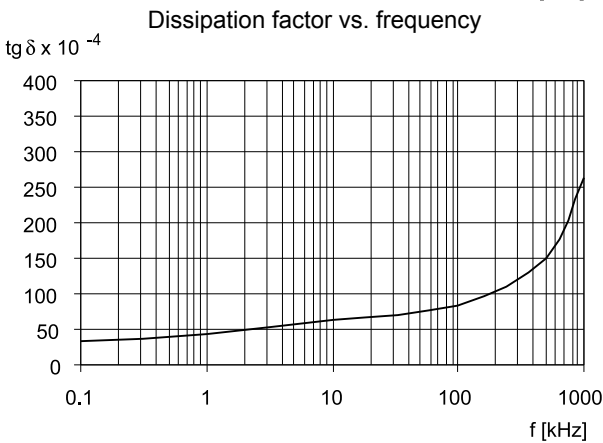
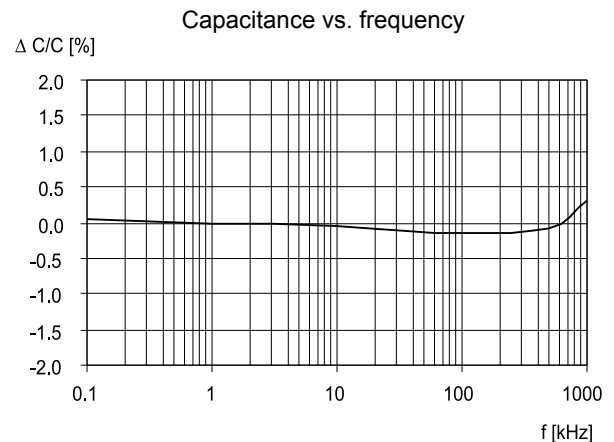
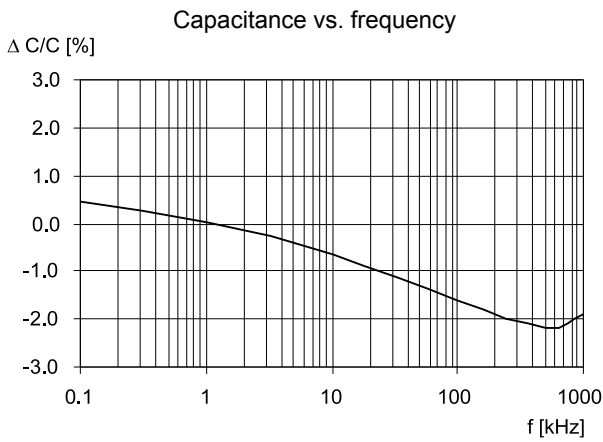

Note: measurements performed at T = 25 ± 5 °C

LDE series - PEN dielectric RoHS 6



LOW VOLTAGE (capacitance range: 1000 pF to 0.047 μF)

Standard and miniature versions

Rated cap.	50 V _{DC} / 40 V _{AC}				63 V _{DC} / 40 V _{AC}				100 V _{DC} / 63 V _{AC}				250 V _{DC} / 120 V _{AC}				Rated cap.
	Size code	Pcs per reel	Hmax [mm]	Part number	Size code	Pcs per reel	Hmax [mm]	Part number	Size code	Pcs per reel	Hmax [mm]	Part number	Size code	Pcs per reel	Hmax [mm]	Part number	
1000 pF	12.06	3000	1.1	LDECA1100 - A0 - - 0	12.06	3000	1.1	LDEDA1100 - A0 - - 0	12.06	3000	1.1	LDEEA1100 - A0 - - 0	12.06	3000	1.1	LDEIA1100 - A0 - - 0	1000 pF
1200 pF	12.06	3000	1.1	LDECA1120 - A0 - - 0	12.06	3000	1.1	LDEDA1120 - A0 - - 0	12.06	3000	1.1	LDEEA1120 - A0 - - 0	12.06	3000	1.1	LDEIA1120 - A0 - - 0	1200 pF
1500 pF	18.12	4000	1.7	LDECC1150 - A5 - - 0	18.12	4000	1.7	LDEDC1150 - A5 - - 0	18.12	4000	1.7	LDEEC1150 - A5 - - 0	18.12	4000	1.7	LDEIC1150 - A5 - - 0	1500 pF
	12.06	3000	1.1	LDECA1150 - A0 - - 0	12.06	3000	1.1	LDEDA1150 - A0 - - 0	12.06	3000	1.1	LDEEA1150 - A0 - - 0	12.06	3000	1.1	LDEIA1150 - A0 - - 0	
1800 pF	18.12	4000	1.7	LDECC1180 - A5 - - 0	18.12	4000	1.7	LDEDC1180 - A5 - - 0	18.12	4000	1.7	LDEEC1180 - A5 - - 0	18.12	4000	1.7	LDEIC1180 - A5 - - 0	1800 pF
	12.06	3000	1.1	LDECA1180 - A0 - - 0	12.06	3000	1.1	LDEDA1180 - A0 - - 0	12.06	3000	1.1	LDEEA1180 - A0 - - 0	12.06	3000	1.1	LDEIA1180 - A0 - - 0	
2200 pF	18.12	4000	1.7	LDECC1220 - A5 - - 0	18.12	4000	1.7	LDEDC1220 - A5 - - 0	18.12	4000	1.7	LDEEC1220 - A5 - - 0	18.12	4000	1.7	LDEIC1220 - A5 - - 0	2200 pF
	12.06	3000	1.1	LDECA1220 - A0 - - 0	12.06	3000	1.1	LDEDA1220 - A0 - - 0	12.06	3000	1.1	LDEEA1220 - A0 - - 0	12.06	3000	1.1	LDEIA1220 - A0 - - 0	
2700 pF	18.12	4000	1.8	LDECC1270 - A5 - - 0	18.12	4000	1.8	LDEDC1270 - A5 - - 0	18.12	4000	1.8	LDEEC1270 - A5 - - 0	18.12	4000	1.8	LDEIC1270 - A5 - - 0	2700 pF
	12.06	3000	1.1	LDECA1270 - A0 - - 0	12.06	3000	1.1	LDEDA1270 - A0 - - 0	12.06	3000	1.1	LDEEA1270 - A0 - - 0	12.06	3000	1.1	LDEIA1270 - A0 - - 0	
3300 pF	18.12	4000	1.7	LDECC1330 - A5 - - 0	18.12	4000	1.7	LDEDC1330 - A5 - - 0	18.12	4000	1.7	LDEEC1330 - A5 - - 0	18.12	4000	1.7	LDEIC1330 - A5 - - 0	3300 pF
	12.06	3000	1.2	LDECA1330 - A0 - - 0	12.06	3000	1.2	LDEDA1330 - A0 - - 0	12.06	3000	1.2	LDEEA1330 - A0 - - 0	12.06	3000	1.2	LDEIA1330 - A0 - - 0	
3900 pF	18.12	4000	1.7	LDECC1390 - A5 - - 0	18.12	4000	1.7	LDEDC1390 - A5 - - 0	18.12	4000	1.7	LDEEC1390 - A5 - - 0	18.12	4000	1.7	LDEIC1390 - A5 - - 0	3900 pF
	12.06	3000	1.1	LDECA1390 - A0 - - 0	12.06	3000	1.1	LDEDA1390 - A0 - - 0	12.06	3000	1.1	LDEEA1390 - A0 - - 0	12.10	2250	1.6	LDEIB1390 - A0 - - 0	
4700 pF	18.12	4000	1.8	LDECC1470 - A5 - - 0	18.12	4000	1.8	LDEDC1470 - A5 - - 0	18.12	4000	1.8	LDEEC1470 - A5 - - 0	18.12	4000	1.8	LDEIC1470 - A5 - - 0	4700 pF
	12.06	3000	1.1	LDECA1470 - A0 - - 0	12.06	3000	1.1	LDEDA1470 - A0 - - 0	12.06	3000	1.1	LDEEA1470 - A0 - - 0	12.10	2250	1.6	LDEIB1470 - A0 - - 0	
5600 pF	18.12	4000	1.7	LDECC1560 - A5 - - 0	18.12	4000	1.7	LDEDC1560 - A5 - - 0	18.12	4000	1.7	LDEEC1560 - A5 - - 0	18.12	4000	1.7	LDEIC1560 - A5 - - 0	5600 pF
	12.06	3000	1.1	LDECA1560 - A0 - - 0	12.06	3000	1.1	LDEDA1560 - A0 - - 0	12.06	3000	1.1	LDEEA1560 - A0 - - 0	12.10	2250	1.6	LDEIB1560 - A0 - - 0	
6800 pF	18.12	4000	1.7	LDECC1680 - A5 - - 0	18.12	4000	1.7	LDEDC1680 - A5 - - 0	18.12	4000	1.7	LDEEC1680 - A5 - - 0	18.12	4000	1.7	LDEIC1680 - A5 - - 0	6800 pF
	12.06	3000	1.1	LDECA1680 - A0 - - 0	12.06	3000	1.1	LDEDA1680 - A0 - - 0	12.06	3000	1.1	LDEEA1680 - A0 - - 0	12.10	2250	1.8	LDEIB1680 - A0 - - 0	
8200 pF	18.12	4000	1.8	LDECC1820 - A5 - - 0	18.12	4000	1.8	LDEDC1820 - A5 - - 0	18.12	4000	1.8	LDEEC1820 - A5 - - 0	18.12	4000	1.8	LDEIC1820 - A5 - - 0	8200 pF
	12.06	3000	1.1	LDECA1820 - A0 - - 0	12.06	3000	1.1	LDEDA1820 - A0 - - 0	12.06	3000	1.1	LDEEA1820 - A0 - - 0	12.10	2250	2.0	LDEIB1820 - A0 - - 0	
0.010 μF	18.12	4000	1.7	LDECC2100 - A5 - - 0	18.12	4000	1.7	LDEDC2100 - A5 - - 0	18.12	4000	1.7	LDEEC2100 - A5 - - 0	18.12	4000	1.7	LDEIC2100 - A5 - - 0	0.010 μF
	12.06	3000	1.1	LDECA2100 - A0 - - 0	12.06	3000	1.1	LDEDA2100 - A0 - - 0	12.06	3000	1.1	LDEEA2100 - A0 - - 0	12.10	2250	2.1	LDEIB2100 - A0 - - 0	
0.012 μF	18.12	4000	1.7	LDECC2120 - A5 - - 0	18.12	4000	1.7	LDEDC2120 - A5 - - 0	18.12	4000	1.7	LDEEC2120 - A5 - - 0	18.12	4000	1.7	LDEIC2120 - A5 - - 0	0.012 μF
	12.06	3000	1.1	LDECA2120 - A0 - - 0	12.06	3000	1.1	LDEDA2120 - A0 - - 0	12.06	3000	1.1	LDEEA2120 - A0 - - 0					
0.015 μF	18.12	4000	1.7	LDECC2150 - A5 - - 0	18.12	4000	1.7	LDEDC2150 - A5 - - 0	18.12	4000	1.7	LDEEC2150 - A5 - - 0	18.12	4000	1.7	LDEIC2150 - A5 - - 0	0.015 μF
	12.06	3000	1.2	LDECA2150 - A0 - - 0	12.06	3000	1.2	LDEDA2150 - A0 - - 0	12.06	3000	1.2	LDEEA2150 - A0 - - 0					
0.018 μF	18.12	4000	1.8	LDECC2180 - A5 - - 0	18.12	4000	1.8	LDEDC2180 - A5 - - 0	18.12	4000	1.8	LDEEC2180 - A5 - - 0	22.20	3000	2.2	LDEID2180 - A5 - - 0	0.018 μF
	12.06	3000	1.1	LDECA2180 - A0 - - 0	12.06	3000	1.1	LDEDA2180 - A0 - - 0	12.10	2250	1.5	LDEEB2180 - A0 - - 0	18.12	4000	1.8	LDEIC2180 - A0 - - 0	
0.022 μF	18.12	4000	1.7	LDECC2220 - A5 - - 0	18.12	4000	1.7	LDEDC2220 - A5 - - 0	18.12	4000	1.7	LDEEC2220 - A5 - - 0	22.20	3000	2.5	LDEID2220 - A5 - - 0	0.022 μF
	12.06	3000	1.1	LDECA2220 - A0 - - 0	12.06	3000	1.1	LDEDA2220 - A0 - - 0	12.10	2250	1.5	LDEEB2220 - A0 - - 0	18.12	3000	2.2	LDEIC2220 - A0 - - 0	
0.027 μF	18.12	4000	1.7	LDECC2270 - A5 - - 0	18.12	4000	1.7	LDEDC2270 - A5 - - 0	18.12	4000	1.7	LDEEC2270 - A5 - - 0	22.20	2250	2.9	LDEID2270 - A5 - - 0	0.027 μF
	12.06	3000	1.1	LDECA2270 - A0 - - 0	12.06	3000	1.1	LDEDA2270 - A0 - - 0	12.10	2250	1.7	LDEEB2270 - A0 - - 0	18.12	3000	2.5	LDEIC2270 - A0 - - 0	
0.033 μF	18.12	4000	1.8	LDECC2330 - A5 - - 0	18.12	4000	1.8	LDEDC2330 - A5 - - 0	18.12	4000	1.8	LDEEC2330 - A5 - - 0	22.20	3000	1.9	LDEID2330 - A5 - - 0	0.033 μF
	12.10	2250	2.0	LDECB2330 - A0 - - 0	12.10	2250	2.0	LDEDB2330 - A0 - - 0	12.10	2250	2.0	LDEEB2330 - A0 - - 0	18.12	3000	2.6	LDEIC2330 - A0 - - 0	
0.039 μF	12.06	3000	1.2	*LDECA2330 - A0 - - 0	12.06	3000	1.2	*LDEDA2330 - A0 - - 0									
	18.12	4000	1.7	LDECC2390 - A5 - - 0	18.12	4000	1.7	LDEDC2390 - A5 - - 0	18.12	4000	1.7	LDEEC2390 - A5 - - 0	22.20	3000	2.1	LDEID2390 - A5 - - 0	0.039 μF
12.10	2250	2.1	LDECB2390 - A0 - - 0	12.10	2250	2.1	LDEDB2390 - A0 - - 0	12.10	2250	2.1	LDEEB2390 - A0 - - 0						
0.047 μF	18.12	4000	1.7	LDECC2470 - A5 - - 0	18.12	4000	1.7	LDEDC2470 - A5 - - 0	18.12	4000	1.7	LDEEC2470 - A5 - - 0	22.20	3000	2.3	LDEID2470 - A5 - - 0	0.047 μF
	12.10	2250	2.1	LDECB2470 - A0 - - 0	12.10	2250	2.1	LDEDB2470 - A0 - - 0	12.10	2250	2.1	LDEEB2470 - A0 - - 0					

Tolerance - Standard: K = ±10%; M = ±20%;
 (J = ±5% available upon request and review of project/application)
 Packaging - N = Taped; A to Z = Special;
 Internal use

* only K and M tolerances available

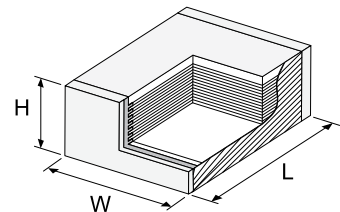

Size code	12.06	12.10	18.12	22.20	28.24	40.30	50.40	60.54
L (mm)	3.3 ^{+0.3} _{-0.1}	3.3 ^{+0.3} _{-0.1}	4.7 ^{+0.3} _{-0.2}	6.0 ± 0.3	7.3 ± 0.4	10.5 ± 0.4	13.0 ± 0.4	15.5 ± 0.4
W (mm)	1.7 ± 0.2	2.5 ± 0.3	3.3 ± 0.3	5.0 ± 0.4	6.1 ± 0.4	7.9 ± 0.5	10.4 ± 0.5	13.7 ± 0.5
P/N 5 th digit	A	B	C	D	E	F	G	H

LDE series - PEN dielectric RoHS 6



LOW VOLTAGE (capacitance range: 0.056 µF to 4.7 µF)

Standard and miniature versions

Rated cap.	50 V _{DC} / 40 V _{AC}				63 V _{DC} / 40 V _{AC}				100 V _{DC} / 63 V _{AC}				250 V _{DC} / 120 V _{AC}				Rated cap.
	Size code	Pcs per reel	Hmax [mm]	Part number	Size code	Pcs per reel	Hmax [mm]	Part number	Size code	Pcs per reel	Hmax [mm]	Part number	Size code	Pcs per reel	Hmax [mm]	Part number	
0.056 µF	18.12	4000	1.7	LDECC2560 - A5 - - 0	18.12	4000	1.7	LDEDC2560 - A5 - - 0	18.12	4000	1.7	LDEEC2560 - A5 - - 0	22.20	3000	2.6	LDEID2560 - A5 - - 0	0.056 µF
	12.10	2250	1.7	LDECB2560 - A0 - - 0	12.10	2250	1.7	LDEDB2560 - A0 - - 0									
0.068 µF	18.12	4000	1.8	LDECC2680 - A5 - - 0	18.12	4000	1.8	LDEDC2680 - A5 - - 0	18.12	4000	1.8	LDEEC2680 - A5 - - 0	22.20	3000	2.8	LDEID2680 - A5 - - 0	0.068 µF
	12.10	2250	2.0	LDECB2680 - A0 - - 0	12.10	2250	2.0	LDEDB2680 - A0 - - 0									
0.082 µF	18.12	3000	2.1	LDECC2820 - A5 - - 0	18.12	3000	2.1	LDEDC2820 - A5 - - 0	18.12	3000	2.1	LDEEC2820 - A5 - - 0	28.24	2250	2.6	LDEIE2820 - A5 - - 0	0.082 µF
	12.10	2250	2.1	LDECB2820 - A0 - - 0	12.10	2250	2.1	LDEDB2820 - A0 - - 0					22.20	2250	3.5	LDEID2820 - A0 - - 0	
0.10 µF	18.12	3000	2.4	LDECC3100 - A5 - - 0	18.12	3000	2.4	LDEDC3100 - A5 - - 0	18.12	3000	2.4	LDEEC3100 - A5 - - 0	28.24	2250	2.9	LDEIE3100 - A5 - - 0	0.10 µF
	12.10	2250	2.1	LDECB3100 - A0 - - 0	12.10	2250	2.1	LDEDB3100 - A0 - - 0					22.20	1750	4.1	LDEID3100 - A0 - - 0	
0.12 µF	18.12	4000	1.7	LDECC3120 - A5 - - 0	18.12	4000	1.7	LDEDC3120 - A5 - - 0	22.20	3000	2.6	LDEED3120 - A5 - - 0	28.24	2250	3.3	LDEIE3120 - A5 - - 0	0.12 µF
													22.20	1750	4.4	LDEID3120 - A0 - - 0	
0.15 µF	18.12	4000	1.9	LDECC3150 - A5 - - 0	18.12	4000	1.9	LDEDC3150 - A5 - - 0	22.20	3000	1.9	LDEED3150 - A5 - - 0	28.24	1750	3.8	LDEIE3150 - A5 - - 0	0.15 µF
	18.12	3000	2.2	LDECC3180 - A5 - - 0	18.12	3000	2.2	LDEDC3180 - A5 - - 0	22.20	3000	2.0	LDEED3180 - A5 - - 0	40.30	1500	2.7	LDEIF3180 - A5 - - 0	
0.18 µF													28.24	1750	4.4	LDEIE3180 - A0 - - 0	0.18 µF
0.22 µF	18.12	3000	2.4	LDECC3220 - A5 - - 0	18.12	3000	2.4	LDEDC3220 - A5 - - 0	22.20	3000	2.4	LDEED3220 - A5 - - 0	40.30	1500	3.1	LDEIF3220 - A5 - - 0	0.22 µF
													28.24	1500	5.2	LDEIE3220 - A0 - - 0	
0.27 µF	22.20	3000	1.9	LDECD3270 - A5 - - 0	22.20	3000	1.9	LDEDD3270 - A5 - - 0	22.20	3000	2.8	LDEED3270 - A5 - - 0	40.30	1500	3.7	LDEIF3270 - A5 - - 0	0.27 µF
	22.20	3000	1.9	LDECD3330 - A5 - - 0	22.20	3000	1.9	LDEDD3330 - A5 - - 0	22.20	2250	3.3	LDEED3330 - A5 - - 0	40.30	1250	4.3	LDEIF3330 - A5 - - 0	
0.33 µF	22.20	3000	2.1	LDECD3390 - A5 - - 0	22.20	3000	2.1	LDEDD3390 - A5 - - 0	28.24	2250	2.6	LDEEE3390 - A5 - - 0	50.40	1500	3.3	LDEIG3390 - A5 - - 0	0.33 µF
									22.20	2250	3.7	LDEED3390 - A0 - - 0	40.30	1000	5.0	LDEIF3390 - A0 - - 0	
0.39 µF	22.20	3000	2.4	LDECD3470 - A5 - - 0	22.20	3000	2.4	LDEDD3470 - A5 - - 0	28.24	2250	3.0	LDEEE3470 - A5 - - 0	50.40	1250	3.8	LDEIG3470 - A5 - - 0	0.39 µF
									22.20	1750	4.4	LDEED3470 - A0 - - 0	40.30	1000	5.5	LDEIF3470 - A0 - - 0	
0.47 µF	22.20	3000	2.8	LDECD3560 - A5 - - 0	22.20	3000	2.8	LDEDD3560 - A5 - - 0	28.24	2250	3.5	LDEEE3560 - A5 - - 0	50.40	1250	4.4	LDEIG3560 - A5 - - 0	0.47 µF
													40.30	1000	5.5	LDEIF3560 M A0 - - 0	
0.56 µF	22.20	2250	3.3	LDECD3680 - A5 - - 0	22.20	2250	3.3	LDEDD3680 - A5 - - 0	28.24	1750	4.1	LDEEE3680 - A5 - - 0	60.54	1000	3.4	LDEIH3680 - A5 - - 0	0.56 µF
													50.40	1000	5.2	LDEIG3680 - A0 - - 0	
0.68 µF	28.24	2250	2.9	LDECE3820 - A5 - - 0	28.24	2250	2.9	LDEDE3820 - A5 - - 0	40.30	1500	2.8	LDEEF3820 - A5 - - 0	60.54	1000	3.9	LDEIH3820 - A5 - - 0	0.68 µF
	22.20	1750	3.7	LDECD3820 - A0 - - 0	22.20	2250	3.7	LDEDD3820 - A0 - - 0	28.24	1500	4.9	LDEEE3820 - A0 - - 0	50.40	1000	5.7	LDEIG3820 - A0 - - 0	
0.82 µF	28.24	2250	3.1	LDECE4100 - A5 - - 0	28.24	2250	3.1	LDEDE4100 - A5 - - 0	40.30	1500	3.2	LDEEF4100 - A5 - - 0	60.54	750	4.6	LDEIH4100 - A5 - - 0	0.82 µF
	22.20	1750	4.4	LDECD4100 - A0 - - 0	22.20	1750	4.4	LDEDD4100 - A0 - - 0	28.24	1500	5.4	*LDEEE4100 - A0 - - 0					
1.0 µF	28.24	2250	3.6	LDECE4120 - A5 - - 0	28.24	2250	3.6	LDEDE4120 - A5 - - 0	50.40	1500	3.1	LDEEG4120 - A5 - - 0	60.54	750	5.4	LDEIH4120 - A0 - - 0	1.0 µF
									40.30	1500	3.7	LDEEF4120 - A0 - - 0					
1.2 µF	50.40	1500	3.1	LDECG4150 - A5 - - 0	50.40	1500	3.1	LDEDG4150 - A5 - - 0	50.40	1500	3.1	LDEEG4150 - A5 - - 0	60.54	750	5.7	LDEIH4150 M A0 - - 0	1.2 µF
	28.24	1750	4.3	LDECE4150 - A0 - - 0	28.24	1750	4.3	LDEDE4150 - A0 - - 0	40.30	1250	4.5	LDEEF4150 - A0 - - 0					
1.5 µF	50.40	1500	3.4	LDECG4180 - A5 - - 0	50.40	1500	3.4	LDEDG4180 - A5 - - 0	50.40	1500	3.4	LDEEG4180 - A5 - - 0					1.5 µF
	28.24	1500	5.1	LDECE4180 - A0 - - 0	28.24	1500	5.1	LDEDE4180 - A0 - - 0	40.30	1000	5.4	LDEEF4180 - A0 - - 0					
1.8 µF	50.40	1250	4.1	LDECG4220 - A5 - - 0	50.40	1250	4.1	LDEDG4220 - A5 - - 0	50.40	1250	4.1	LDEEG4220 - A5 - - 0					1.8 µF
	40.30	1500	3.3	LDECF4220 - A0 - - 0	40.30	1500	3.3	LDEDF4220 - A0 - - 0	40.30	1000	5.6	*LDEEF4220 - A0 - - 0					
2.2 µF	50.40	1000	4.9	LDECG4270 - A5 - - 0	50.40	1000	4.9	LDEDG4270 - A5 - - 0	60.54	1000	3.3	LDEEH4270 - A5 - - 0					2.2 µF
	40.30	1250	4.0	LDECF4270 - A0 - - 0	40.30	1250	4.0	LDEDF4270 - A0 - - 0	50.40	1000	4.9	LDEEG4270 - A0 - - 0					
2.7 µF	60.54	1000	3.9	LDECH4330 - A5 - - 0	60.54	1000	3.9	LDEDH4330 - A5 - - 0	60.54	1000	3.9	LDEEH4330 - A5 - - 0					2.7 µF
	40.30	1000	4.7	LDECF4330 - A0 - - 0	40.30	1000	4.7	LDEDF4330 - A0 - - 0	50.40	1000	5.7	LDEEG4330 - A0 - - 0					
3.3 µF	60.54	750	4.5	LDECH4390 - A5 - - 0	60.54	750	4.5	LDEDH4390 - A5 - - 0	60.54	750	4.5	LDEEH4390 - A5 - - 0					3.3 µF
	40.30	1000	5.5	LDECF4390 - A0 - - 0	40.30	1000	5.5	LDEDF4390 - A0 - - 0									
3.9 µF	60.54	750	5.3	LDECH4470 - A5 - - 0	60.54	750	5.3	LDEDH4470 - A5 - - 0	60.54	750	5.3	LDEEH4470 - A5 - - 0					3.9 µF
	50.40	1250	4.1	LDECG4470 - A0 - - 0	50.40	1250	4.1	LDEDG4470 - A0 - - 0									
4.7 µF																	4.7 µF

Tolerance - Standard: K = ±10%; M = ±20%; _____
 (J = ±5% available upon request and review of project/application)
 Packaging - N = Taped; A to Z = Special; _____
 Internal use _____

* only K and M tolerances available

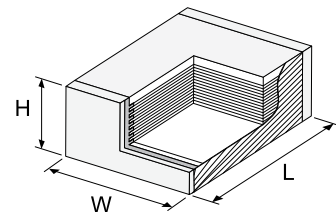

Size code	12.10	18.12	22.20	28.24	40.30	50.40	60.54
L (mm)	3.3 ^{+0.3} _{-0.1}	4.7 ^{+0.3} _{-0.2}	6.0 ± 0.3	7.3 ± 0.4	10.5 ± 0.4	13.0 ± 0.4	15.5 ± 0.4
W (mm)	2.5 ± 0.3	3.3 ± 0.3	5.0 ± 0.4	6.1 ± 0.4	7.9 ± 0.5	10.4 ± 0.5	13.7 ± 0.5
P/N 5 th digit	B	C	D	E	F	G	H

LDE series - PEN dielectric RoHS 6



HIGH VOLTAGE (capacitance range: 1000 pF to 0.47 μF)

Standard and miniature versions

Rated cap.	400 V _{DC} / 160 V _{AC} **				630 V _{DC} / 200 V _{AC}				1000 V _{DC} / 250 V _{AC}				Rated cap.
	Size code	Pcs per reel	H _{max} [mm]	Part number	Size code	Pcs per reel	H _{max} [mm]	Part number	Size code	Pcs per reel	H _{max} [mm]	Part number	
1000 pF					22.20	3000	1.9	LDEPD1100 - A5 - - 0	22.20	3000	1.9	LDEQD1100 - A5 - - 0	1000 pF
1200 pF					22.20	3000	2.0	LDEPD1120 - A5 - - 0	22.20	3000	2.0	LDEQD1120 - A5 - - 0	1200 pF
1500 pF					22.20	3000	2.3	LDEPD1150 - A5 - - 0	22.20	3000	2.3	LDEQD1150 - A5 - - 0	1500 pF
1800 pF					22.20	3000	2.5	LDEPD1180 - A5 - - 0	22.20	3000	2.5	LDEQD1180 - A5 - - 0	1800 pF
2200 pF					22.20	3000	2.0	LDEPD1220 - A5 - - 0	22.20	3000	2.0	LDEQD1220 - A5 - - 0	2200 pF
2700 pF					22.20	3000	2.3	LDEPD1270 - A5 - - 0	22.20	3000	2.3	LDEQD1270 - A5 - - 0	2700 pF
3300 pF					22.20	3000	2.6	LDEPD1330 - A5 - - 0	22.20	3000	2.6	LDEQD1330 - A5 - - 0	3300 pF
3900 pF					22.20	3000	1.9	LDEPD1390 - A5 - - 0	22.20	2250	3.0	LDEQD1390 - A5 - - 0	3900 pF
4700 pF					22.20	3000	2.0	LDEPD1470 - A5 - - 0	22.20	2250	3.4	LDEQD1470 - A5 - - 0	4700 pF
5600 pF					22.20	3000	2.0	LDEPD1560 - A5 - - 0	22.20	1750	3.9	LDEQD1560 - A5 - - 0	5600 pF
6800 pF					22.20	3000	2.3	LDEPD1680 - A5 - - 0	22.20	1750	4.4	LDEQD1680 - A5 - - 0	6800 pF
8200 pF					22.20	3000	2.6	LDEPD1820 - A5 - - 0	28.24	2250	2.9	LDEQE1820 - A5 - - 0	8200 pF
0.010 μF					22.20	2250	3.0	LDEPD2100 - A5 - - 0	28.24	2250	3.4	LDEQE2100 - A5 - - 0	0.010 μF
0.012 μF					22.20	2250	3.4	LDEPD2120 - A5 - - 0	28.24	1750	4.0	LDEQE2120 - A5 - - 0	0.012 μF
0.015 μF	22.20	3000	2.1	LDEMD2150 - A5 - - 0	22.20	1750	4.0	LDEPD2150 - A5 - - 0	28.24	1500	4.9	LDEQE2150 - A5 - - 0	0.015 μF
0.018 μF	22.20	3000	2.2	LDEMD2180 - A5 - - 0	22.20	1750	4.4	LDEPD2180 - A5 - - 0	28.24	1500	5.4	LDEQE2180 - A5 - - 0	0.018 μF
0.022 μF	22.20	3000	2.5	LDEMD2220 - A5 - - 0	28.24	2250	3.4	LDEPE2220 - A5 - - 0	40.30	1500	3.4	LDEQF2220 - A5 - - 0	0.022 μF
0.027 μF	22.20	2250	2.9	LDEMD2270 - A5 - - 0	28.24	1750	4.0	LDEPE2270 - A5 - - 0	40.30	1250	4.1	LDEQF2270 - A5 - - 0	0.027 μF
0.033 μF	22.20	2250	3.4	LDEMD2330 - A5 - - 0	28.24	1500	4.7	LDEPE2330 - A5 - - 0	40.30	1000	4.9	LDEQF2330 - A5 - - 0	0.033 μF
0.039 μF	22.20	1750	3.8	LDEMD2390 - A5 - - 0	28.24	1500	5.3	LDEPE2390 - A5 - - 0	50.40	1500	3.5	LDEQG2390 - A5 - - 0	0.039 μF
0.047 μF	22.20	1750	4.4	LDEMD2470 - A5 - - 0	40.30	1500	3.4	LDEPF2470 - A5 - - 0	50.40	1250	4.1	LDEQG2470 - A5 - - 0	0.047 μF
0.056 μF	28.24	2250	3.5	LDEME2560 - A5 - - 0	40.30	1250	3.9	LDEPF2560 - A5 - - 0	50.40	1000	4.7	LDEQG2560 - A5 - - 0	0.056 μF
0.068 μF	28.24	1750	4.1	LDEME2680 - A5 - - 0	40.30	1250	4.5	LDEPF2680 - A5 - - 0	50.40	1000	5.5	LDEQG2680 - A5 - - 0	0.068 μF
0.082 μF	28.24	1500	4.7	LDEME2820 - A5 - - 0	40.30	1000	5.4	LDEPF2820 - A5 - - 0	60.54	1000	4.2	LDEQH2820 - A5 - - 0	0.082 μF
0.10 μF	28.24	1500	5.4	LDEME3100 - A5 - - 0	50.40	1250	3.9	LDEPG3100 - A5 - - 0	60.54	750	4.8	LDEQH3100 - A5 - - 0	0.10 μF
					40.30	1000	5.5	*LDEPF3100 - A0 - - 0					
0.12 μF	40.30	1500	3.6	LDEMF3120 - A5 - - 0	50.40	1250	4.4	LDEPG3120 - A5 - - 0					0.12 μF
0.15 μF	40.30	1250	4.4	LDEMF3150 - A5 - - 0	50.40	1000	5.3	LDEPG3150 - A5 - - 0					0.15 μF
0.18 μF	40.30	1000	5.1	LDEMF3180 - A5 - - 0	60.54	1000	4.2	LDEPH3180 - A5 - - 0					0.18 μF
0.22 μF	50.40	1250	3.8	LDEMG3220 - A5 - - 0	60.54	750	4.9	LDEPH3220 - A5 - - 0					0.22 μF
0.27 μF	50.40	1000	4.7	LDEMG3270 - A5 - - 0	60.54	750	5.7	*LDEPH3270 - A5 - - 0					0.27 μF
0.33 μF	50.40	1000	5.6	LDEMG3330 - A5 - - 0									0.33 μF
0.39 μF	60.54	1000	4.2	LDEMH3390 - A5 - - 0									0.39 μF
0.47 μF	60.54	750	4.8	LDEMH3470 - A5 - - 0									0.47 μF

Tolerance - Standard: K = ±10%; M = ±20%;
 (J = ±5% available upon request and review of project/application)
 Packaging - N = Taped; A to Z = Special;
 Internal use

* only K and M tolerances available
 ** up to 230 V_{AC} for maximum 30 minutes



ITU compliant version available upon request

Size code	22.20	28.24	40.30	50.40	60.54
L (mm)	6.0 ± 0.3	7.3 ± 0.4	10.5 ± 0.4	13.0 ± 0.4	15.5 ± 0.4
W (mm)	5.0 ± 0.4	6.1 ± 0.4	7.9 ± 0.5	10.4 ± 0.5	13.7 ± 0.5
P/N 5 th digit	D	E	F	G	H

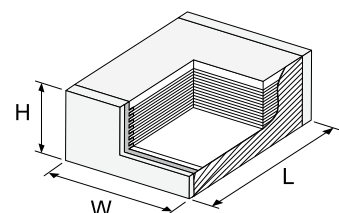

LDE series - PEN dielectric RoHS 6 - technical data

Plates	Aluminium layer deposited by evaporation under vacuum.
Winding	Non inductive - Stacked technology.
Terminations	Four layers: aluminium, brass, nickel, pure tin.
Marking	On packaging only.
Climatic category	55 / 125 / 56

Electrical data

Operating temperature range	-55 to +125 °C
Rated voltage (V _R)	50 - 63 - 100 - 250 - 400 - 630 - 1000 V _{DC}
Category voltage (V _C)	V _C = V _R up to 105 °C. For temperatures between 105 and 125 °C a decreasing factor of 1.25% per degree °C has to be applied on the rated voltage (D.C. and A.C.)
Size range	12.06 to 60.54 (customized sizes available upon request)
Capacitance range	1000 pF to 4.7 μF
Capacitance values	E12 series
Capacitance tolerances	Standard: K = ± 10 % M = ± 20 %; (J = ±5% available upon request and review of project/application)
Dissipation factor (tgδ)	≤ 0.8 % (T = 25 ± 5 °C; f = 1 kHz)
Dielectric absorption	0.8%
Insulation resistance	≥ 1 GΩ for C ≤ 0.33 μF ≥ 400 s for C > 0.33 μF Test conditions: T = 25 ± 5 °C; charging time: 1 min. Charging voltage: 10 V _{DC} for V _R < 100 V _{DC} 100 V _{DC} for V _R ≥ 100 V _{DC}
Surge voltage test	1.4 x V _R (2 s; T = 25 ± 5 °C) for V _R ≤ 630 V _{DC} 1.5 x V _R (2 s; T = 25 ± 5 °C) for V _R = 1000 V _{DC}
Maximum dv / dt	100 V / μs for V _R ≤ 630 V _{DC} 300 V / μs for V _R = 1000 V _{DC}

Dissipation (A.C. applications)

When a capacitor is used in A.C. applications at high frequency, the consequent internal heating may cause the risk of smoke or fire. This is due to the high current flowing through the capacitor's Equivalent Series Resistance.

The formula to calculate the maximum power [W] dissipated by the capacitor is the following:

$$P_{C \max} = \sum_{i=1}^N V_{rms_i}^2 * 2\pi f_i * C * tg\delta_{\max}(f_i) =$$

$$= \sum_{i=1}^N \frac{I_{rms_i}^2}{2\pi f_i * C} * tg\delta_{\max}(f_i)$$

(N: number of significant harmonics)

The formula to calculate the maximum power [W] that can be dissipated by the capacitor is the following:

$$P_{C \lim} = \frac{\Delta T_{\lim}}{R_{th}}$$

It must be: P_{Cmax} ≤ P_{Clim}

Please refer to the table and graph below for ΔT_{lim} and R_{th} values

(T_h: maximum ambient temperature surrounding the capacitor or hottest contact point - i.e. tracks - whichever is higher, in the worst operating conditions in °C)

Tests and performances

Damp heat (40°C/93% R.H.; 56 days)	ΔC/C ≤ 7%; Δtgδ ≤ 50 x 10 ⁻⁴ ; IR ≥ 50% of the limit value
Endurance (125 °C; 2000 h; 1.25 x V _C)	ΔC/C ≤ 5%; Δtgδ ≤ 50 x 10 ⁻⁴ ; IR ≥ 50% of the limit value
Rapid change of temperature (1h at -55 °C; 1h at +125 °C; 1000 cycles)	ΔC/C ≤ 5% Δtgδ ≤ 50 x 10 ⁻⁴ IR ≥ limit value No mechanical damage
Reflow (as per reflow recommendations, see page 14)	ΔC/C ≤ 3% Δtgδ ≤ 50 x 10 ⁻⁴ IR ≥ limit value No mechanical damage
Bending (1 to 6 mm deflection)	ΔC/C ≤ 1% No visible damage on the terminations (peeling) neither on the body (cracking)
Long term stability (2 years)	ΔC/C ≤ 3% for sizes ≤ 22.20 ΔC/C ≤ 2% for sizes > 22.20
Reliability (REF MIL HDBK 217)	Failure rate ≤ 1 Fit 1 Fit = 10 ⁻⁹ failures / (components * hours)

Size	12.06	12.10	18.12	22.20			28.24			
H _{max} [mm]	1.2	2.1	1.7	2.6	2.3	3.3	4.4	3.5	4.5	5.4
R _{th} [°C/W]	175	165	157	151	135	128	122	114	108	103
Size	40.30			50.40			60.54			
H _{max} [mm]	3.6	4.5	5.5	3.6	4.5	5.7	3.6	4.5	5.7	
R _{th} [°C/W]	93	88	84	75	70	66	58	55	52	

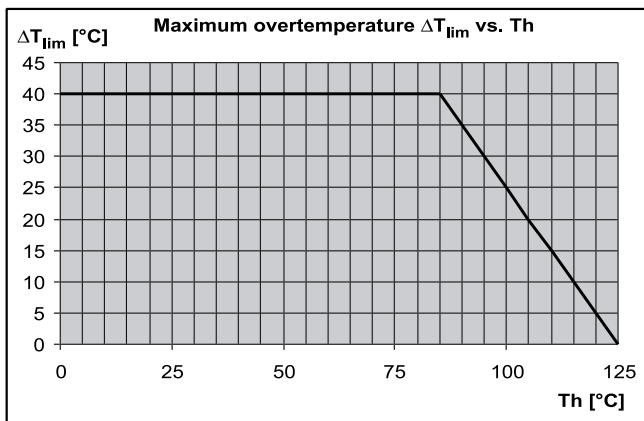

LDE series - PEN dielectric RoHS 6

MAXIMUM V_{RMS} and I_{RMS} vs. frequency (50 - 63 - 100 - 250 V_{DC} rated voltage)

(Sinusoidal wave form / $T_h^* \leq 85^\circ C$)

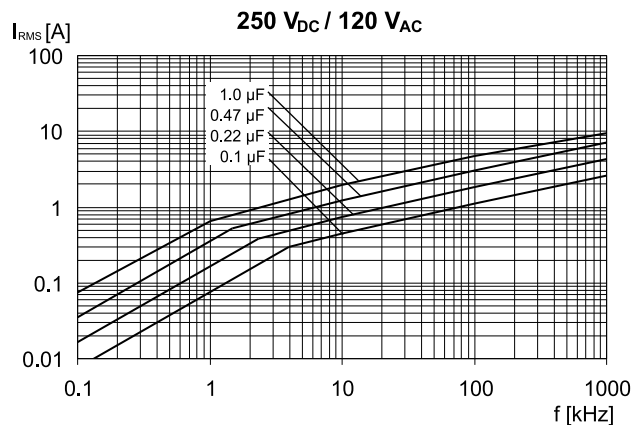
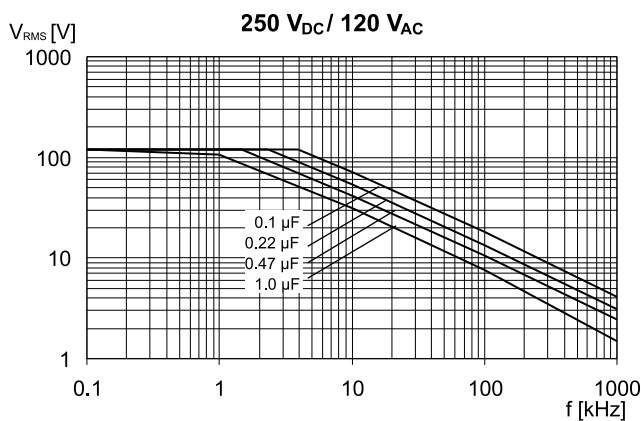
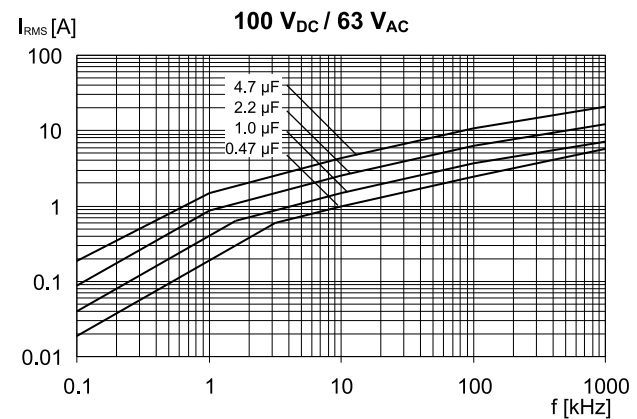
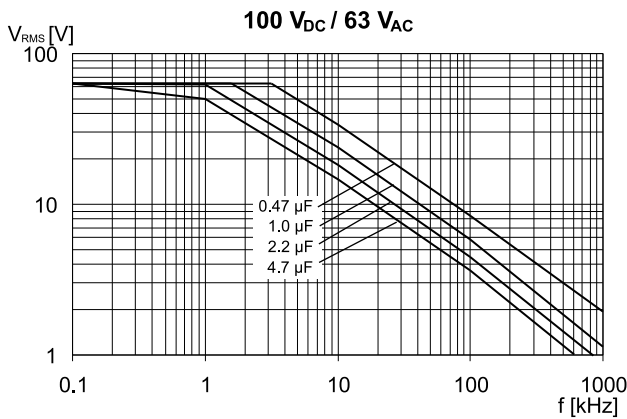
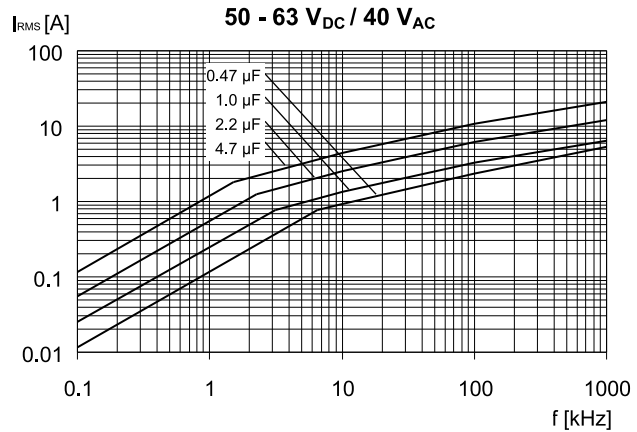
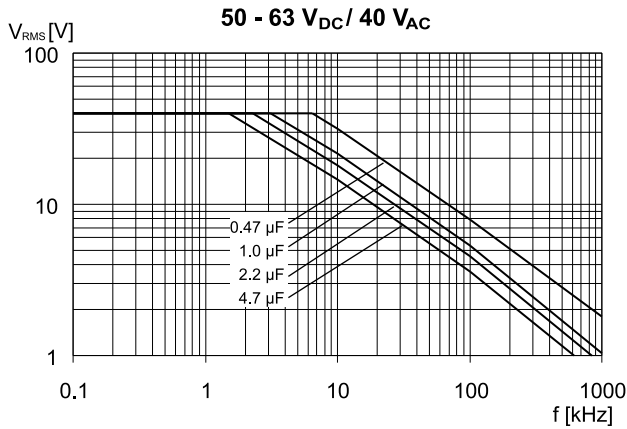

Note: measurements performed in free air condition

* T_h : maximum ambient temperature surrounding the capacitor or hottest contact point - i.e. tracks - whichever is higher, in the worst operating conditions in $^\circ C$

LDE series - PEN dielectric RoHS 6

MAXIMUM V_{RMS} and I_{RMS} vs. frequency (400 - 630 - 1000 V_{DC} rated voltage)

(Sinusoidal wave form / $T_h^* \leq 85^\circ C$)

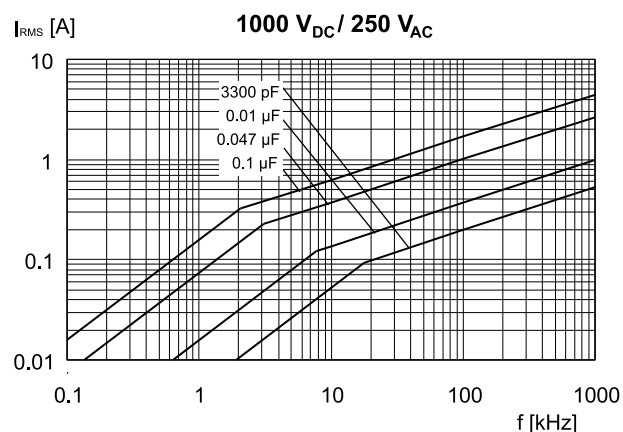
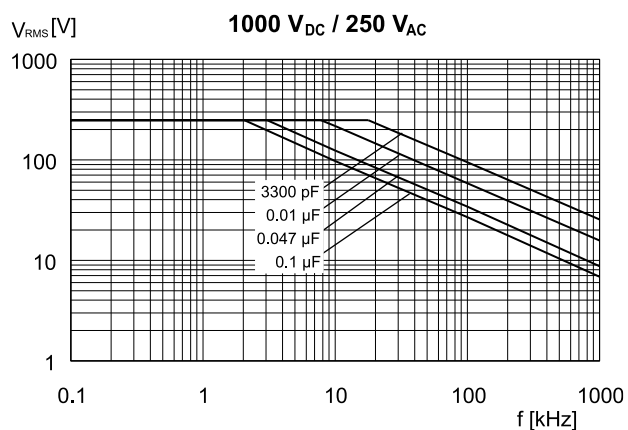
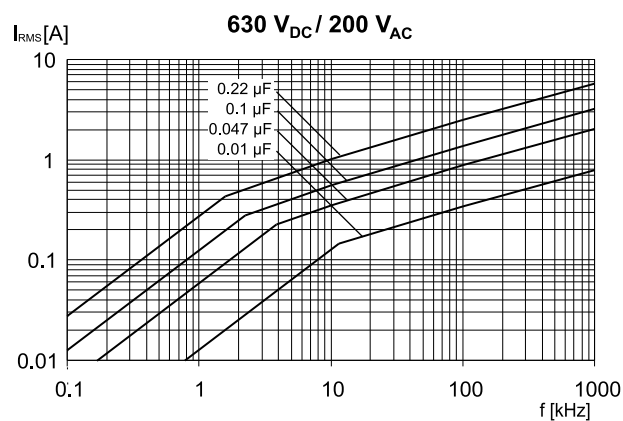
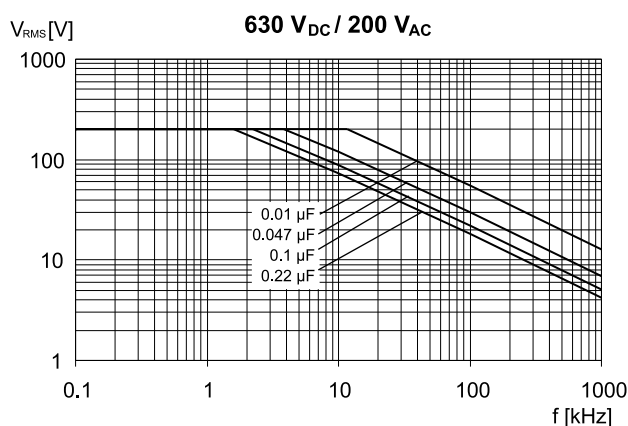
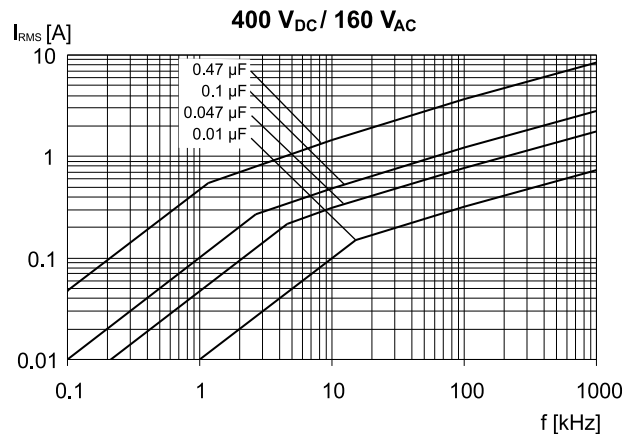
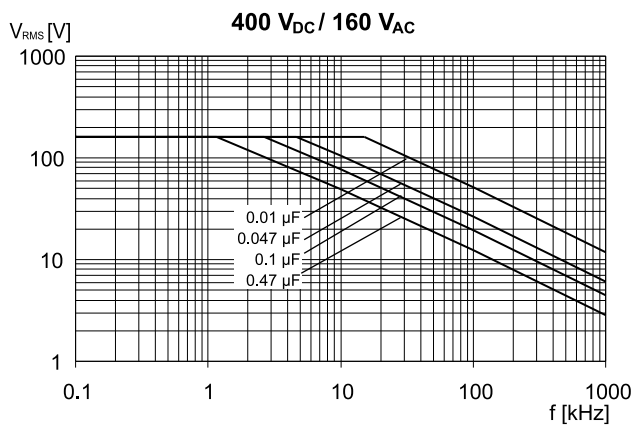

Note: measurements performed in free air condition

* T_h : maximum ambient temperature surrounding the capacitor or hottest contact point - i.e. tracks - whichever is higher, in the worst operating conditions in $^\circ C$

LDB series - PPS dielectric RoHS 6



Standard version

Rated capacitance	16 V _{DC}				50 V _{DC}				Rated capacitance
	Size code	Pcs per reel	H _{max} [mm]	Part number	Size code	Pcs per reel	H _{max} [mm]	Part number	
3300 pF					12.06	3000	1.1	LDBCA1330 - C5 --	3300 pF
3900 pF					12.06	3000	1.1	LDBCA1390 - C5 --	3900 pF
4700 pF					12.06	3000	1.1	LDBCA1470 - C5 --	4700 pF
5600 pF					12.06	3000	1.1	LDBCA1560 - C5 --	5600 pF
6800 pF					12.06	3000	1.1	LDBCA1680 - C5 --	6800 pF
8200 pF					12.06	3000	1.1	LDBCA1820 - C5 --	8200 pF
0.010 µF					12.06	3000	1.1	LDBCA2100 - C5 --	0.010 µF
0.012 µF	12.06	3000	1.1	LDBAA2120 - C5 --	12.06	3000	1.1	LDBCA2120 - C5 --	0.012 µF
0.015 µF	12.06	3000	1.1	LDBAA2150 - C5 --	12.10	2250	1.4	LDBCB2150 - C5 --	0.015 µF
0.018 µF	12.06	3000	1.1	LDBAA2180 - C5 --	12.10	2250	1.5	LDBCB2180 - C5 --	0.018 µF
0.022 µF	12.06	3000	1.1	LDBAA2220 - C5 --	12.10	2250	1.5	LDBCB2220 - C5 --	0.022 µF
0.027 µF	12.06	3000	1.1	LDBAA2270 - C5 --	12.10	2250	1.5	LDBCB2270 - C5 --	0.027 µF
0.033 µF	12.06	3000	1.1	LDBAA2330 - C5 --	12.10	2250	1.7	LDBCB2330 - C5 --	0.033 µF
0.039 µF	12.06	3000	1.2	LDBAA2390 - C5 --	12.10	2250	1.9	LDBCB2390 - C5 --	0.039 µF
0.047 µF	12.06	3000	1.3	LDBAA2470 - C5 --	12.10	2250	2.3	LDBCB2470 - C5 --	0.047 µF
0.056 µF	12.10	2250	1.7	LDBAB2560 - C5 --	18.12	4000	1.7	LDBCC2560 - C5 --	0.056 µF
0.068 µF	12.10	2250	1.7	LDBAB2680 - C5 --	18.12	4000	1.7	LDBCC2680 - C5 --	0.068 µF
0.082 µF	12.10	2250	1.7	LDBAB2820 - C5 --	18.12	4000	1.7	LDBCC2820 - C5 --	0.082 µF
0.10 µF	12.10	2250	2.0	LDBAB3100 - C5 --	18.12	3000	2.0	LDBCC3100 - C5 --	0.10 µF

Tolerance - G = ±2%; J = ±5%;
 Packaging - N = Taped; A to Z = Special;
 Internal use _____

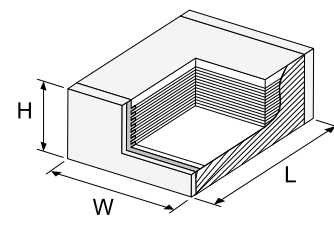

Size code	12.06	12.10	18.12
L (mm)	3.3 ^{+0.3} / _{-0.1}	3.3 ^{+0.3} / _{-0.1}	4.7 ^{+0.3} / _{-0.2}
W (mm)	1.7 ± 0.2	2.5 ± 0.3	3.3 ± 0.3
P/N 5 th digit	A	B	C

LDB series - PPS dielectric RoHS 6 - technical data

Plates	Aluminium layer deposited by evaporation under vacuum.
Winding	Non inductive - Stacked technology.
Terminations	Four layers: aluminium, brass, nickel, pure tin.
Marking	On packaging only.
Climatic category	55 / 125 / 56

Electrical data

Operating temperature range	-55 to + 125 °C
Rated voltage (V_R)	16 - 50 V_{DC}
Category voltage (V_C)	$V_C = V_R$ up to 105 °C. For temperatures between 105 and 125 °C a decreasing factor of 1.25 % per degree °C has to be applied on the D.C. rated voltage
Size range	12.06 to 18.12
Capacitance range	3300 pF to 0.1 μ F
Capacitance values	E12 series
Capacitance tolerances	± 2 % (G); ± 5 % (J)
Dissipation factor ($tg\delta$)	≤ 0.6 % ($T = 25 \pm 5$ °C; $f = 1$ kHz)
Dielectric absorption	0.02%
Insulation resistance	≥ 3 G Ω Test conditions: $T = 25 \pm 5$ °C; charging time: 1 min. Charging voltage: 10 V_{DC} for $V_R = 16$ V_{DC} 50 V_{DC} for $V_R = 50$ V_{DC}
Surge voltage test	$1.75 \times V_R$ (5 s; $T = 25 \pm 5$ °C)

Tests and performances

Damp heat (40 °C / 93% R.H.; 56 days)	$ \Delta C/C \leq 5\%$; $ \Delta tg\delta \leq 30 \times 10^{-4}$; IR $\geq 50\%$ of the limit value
Endurance (125 °C; 2000 h; $1.25 \times V_C$)	$ \Delta C/C \leq 3\%$; $ \Delta tg\delta \leq 30 \times 10^{-4}$; IR $\geq 50\%$ of the limit value
Rapid change of temperature (1h at -55 °C; 1h at +125 °C; 1000 cycles)	$ \Delta C/C \leq 3\%$ $ \Delta tg\delta \leq 50 \times 10^{-4}$ IR \geq limit value No mechanical damage
Reflow (as per reflow recommendations, see page 14)	$ \Delta C/C \leq 3\%$; $ \Delta tg\delta \leq 50 \times 10^{-4}$; IR \geq limit value No mechanical damage
Bending (1 to 6 mm deflection)	$ \Delta C/C \leq 1\%$ No visible damage on the terminations (peeling) neither on the body (cracking)
Long term stability (2 years)	$ \Delta C/C \leq 1\%$
Reliability (REF. MIL HDBK 217)	Failure rate ≤ 1 Fit 1 Fit = 10^{-9} failures / (components * hours)

Soldering recommendations and cautions

Reflow recommendations

Preheating

Maximum preheating time: 180 s
 Minimum temperature: 150 °C
 Maximum temperature: 200 °C

Maximum time within T_{max} and $T_{max} - 5\text{ °C}$ (ΔT_5):

30 s ($T_{max} \leq 250\text{ °C}$)
 10 s ($250\text{ °C} < T_{max} \leq 255\text{ °C}^*$)

Maximum time over 217 °C (ΔT_{217}): 150 s

Maximum temperature on the component's body (T_{max}):

Capacitor H_{max} [mm]	Capacitor volume [mm ³]		
	< 350	350 - 2000	> 2000
< 1.6	255 °C *	255 °C *	255 °C *
1.6 - 2.5	255 °C *	250 °C	245 °C
> 2.5	250 °C	245 °C	245 °C

Maximum temperature ramp rate:

3 °C / s (heating)
 6 °C / s (cooling)

Second reflow

if two reflow processes are needed, be sure that, before the second reflow, the temperature on the capacitor's surface is lower than 50 °C.

in line with JEDEC STD 020D ed. June 2007 with some limitations * For LDB series this value is 260 °C.

Reflow temperature profile

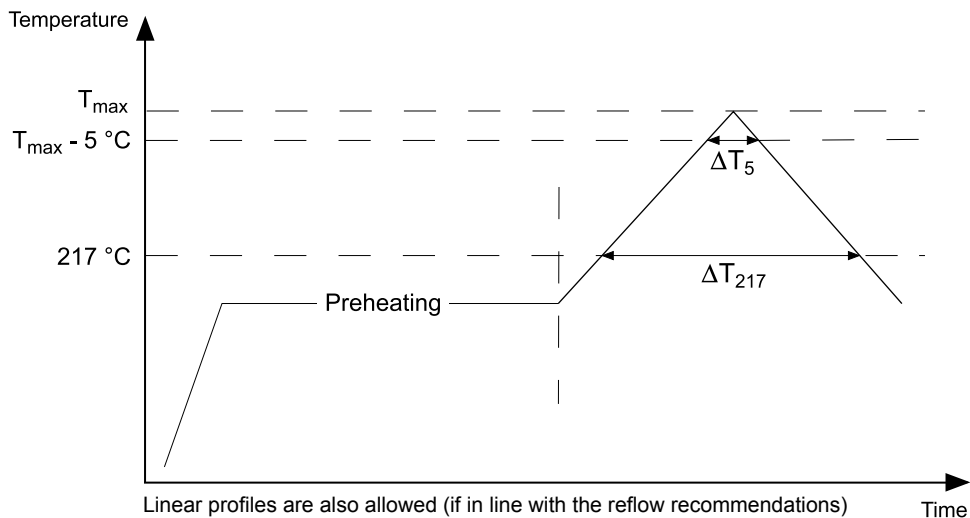

Landing areas and solder paste suggestions

Size **	A [mm]	B [mm]	C [mm]	D [mm]
12.06	1.5	1.1	2.3	4.5
12.10	2.3	1.1	2.3	4.5
18.12	3.0	1.7	3.1	6.5
22.20	4.6	2.1	3.9	8.1
28.24	5.7	2.3	5.3	9.9
40.30	7.4	2.6	8.2	13.4
50.40	9.6	2.6	10.7	15.9
60.54	12.6	2.6	13.2	18.4

** For customized sizes, specific landing areas suggestions are available

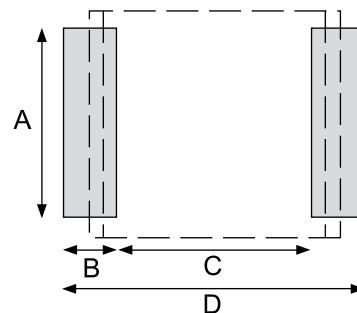

These new landing area dimensions have the aim of taking full advantage of the new RoHS 6 terminations design.

We suggest to use a Sn / Ag / Cu solder paste (suggested thickness: 0.10 ÷ 0.15 mm).

The preceding layout (2004 Catalogue) is therefore to be considered still valid, although not optimal for RoHS 6.

If a NOT Lead Free solder paste is used, a minimum peak temperature of 210 °C on the component's body is suggested.

Soldering recommendations and cautions

Flux / Cleaning / Storage and Moisture

Flux suggestions

We suggest to use a no-clean flux with a halogen content lower than 0.1%.

Cleaning suggestions

To clean the PCB assembly we suggest to use a suitable solvent like Isopropyl Alcohol, deionized water or neutral pH detergents. Solvents like Toluene, Xylene and Trichloroethylene should not be used.

Storage and moisture recommendations

Arcotronics SMD Film Capacitors are supplied in a MBB (Moisture Barrier Bag) Class 1. We can guarantee a 24 months shelf life (temperature $\leq 40\text{ }^{\circ}\text{C}$ / relative humidity $\leq 90\%$).

After the MBB has been opened, components may stay in areas with controlled temperature and humidity (temperature $\leq 30\text{ }^{\circ}\text{C}$ / relative humidity $\leq 60\%$) for 168 hours (rated voltage $\leq 100\text{ V}_{\text{DC}}$) or 696 hours (rated voltage $> 100\text{ V}_{\text{DC}}$).

For longer periods of time and / or higher temperature and / or higher relative humidity values, it is absolutely necessary to protect the components against humidity. If the reel inside the MBB is partially used, Arcotronics recommends to re-use the same MBB or to avoid areas without controlled temperature and humidity (see above). If the above conditions are not respected, components require a baking (minimum time: 48 hours at $55 \pm 5\text{ }^{\circ}\text{C}$) before the reflow.

Manual assembly recommendations

If PCBs are assembled manually, care must be taken to avoid any mechanical damage to the components.

Our recommendations are the following (see Fig. 1):

- 1) when using tweezers, the components should be gripped across the two terminations (A);
- 2) avoid any contact with the two cutting surfaces (C);
- 3) a vacuum pen is recommended on the top and bottom surfaces (B).

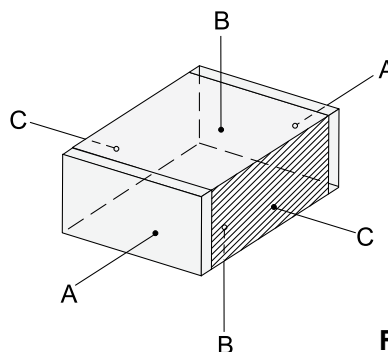

Fig. 1

Manual soldering recommendations

LDE and LDB series have been designed for Surface Mount Technology, pick & place machines and reflow soldering systems. Using a manual soldering iron, issues may occur because the typical temperature for manual soldering is around $350\text{ }^{\circ}\text{C}$. Therefore please pay careful attention:

- never touch the capacitor body with the soldering iron but rather touch the soldering iron and the end termination with the tin wire edge (see Fig. 2);
- if the soldering iron is equipped with a temperature controller device: set the temperature to $250 \pm 3\text{ }^{\circ}\text{C}$ and proceed as per Fig. 2 (the maximum soldering time, on both terminations, is 5 s);
- if the soldering iron is NOT equipped with a temperature controller device: this is the worst situation. The following are a few practical suggestions but, clearly, the operator's experience is extremely important:
 - 1) proceed as per Fig. 2;
 - 2) as soon as the tin wire starts melting, move the soldering iron away as quickly as possible;
 - 3) wait a few seconds and check that the soldering joint has been properly created;
- if the soldering iron is equipped with a hot air flow device: set the hot air temperature to $250 \pm 3\text{ }^{\circ}\text{C}$ and do not send the hot air directly onto the capacitor plastic body. In this situation, the operator's experience is very important;
- in any case, avoid mass-mounting SMD Film Capacitors manually.

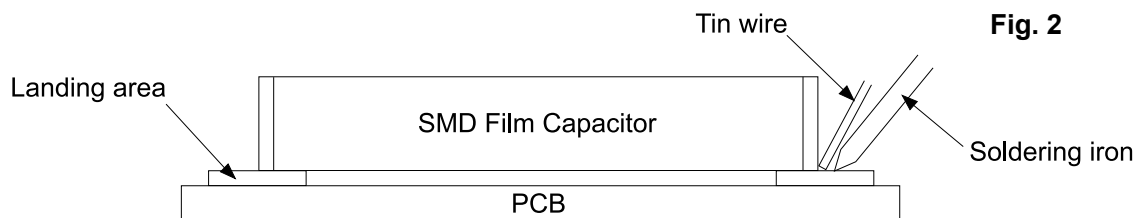

Fig. 2

Production process basic suggestions

In case of:	Typical cause	Typical solution
no solder joint on one end termination	landing area dimensions	see landing areas suggestions, page 14
	solder paste quality	see solder paste suggestions, page 14
	not-uniform solder paste thickness on the landing areas	set the dispensing solder paste machine properly
	wrong position of the capacitor on the landing areas	set the pick & place machine properly
	thermal profile parameters	see reflow recommendations, page 14
	bad temperature distribution in the reflow oven	check the reflow oven temperature distribution and variations
no solder joint on both end terminations	landing area dimensions	see landing areas suggestions, page 14
	solder paste quality	see solder paste suggestions, page 14
	no solder paste on the landing areas	set the dispensing solder paste machine properly
	thermal profile parameters	see reflow recommendations, page 14
	bad temperature distribution in the reflow oven	check the reflow oven temperature distribution and variations
	oxidated end terminations	see moisture recommendations, page 15
capacitor's body mechanical deformation	too long time over 217 °C	see reflow recommendations, page 14
	too long time within T_{max} and $T_{max} - 5$ °C	see reflow recommendations, page 14
	too high temperature ramp rate	see reflow recommendations, page 14
	capacitor damaged by a soldering iron	see manual soldering recommendations, page 15
capacitance drop (up to 20%)	too long time over 217 °C	see reflow recommendations, page 14
	too long time within T_{max} and $T_{max} - 5$ °C	see reflow recommendations, page 14
	too high temperature ramp-up rate	see reflow recommendations, page 14
	capacitor damaged by a soldering iron	see manual soldering recommendations, page 15
capacitance drop (over 20%)	capacitor damaged by a soldering iron	see manual soldering recommendations, page 15

Note: small fissures on the capacitor's cutting surface are actually slight detachments of two adjacent metallized film layers and have to be considered only as an aesthetic issue related to the SMD Film Capacitors' manufacturing process and technology.

Therefore, small fissures on SMD Film Capacitors are not comparable to cracks on SMD Ceramics.

Fissures do not influence in anyway SMD Film Capacitors' reliability.