

AMECO

Presents The New Ameco 2 & 6 Meter Transmitter



Model TX-62
Wired & Tested only \$149.95

In response to the demand for an inexpensive VHF transmitter, Ameco has brought out its Model TX-62. It is a complete 6 and 2 meter, 75 watt phone and CW transmitter. The A-C power supply is built in. It is easy to tune. All circuits up to the final are broadbanded. Since the meter can read RF output, all one has to do to tune up the transmitter is to peak the final plate and loading capacitors for maximum reading.

The TX-62 is an attractive, compact, modern-styled unit with a light gray panel and dark gray cabinet. It is 11½" wide by 9" deep by 6" high. Full 100% modulation is achieved with the well-known Ameco modulation system.

Steps have been taken to insure proper heat dissipation, thereby increasing the life of the parts. The cabinet is completely perforated and parts of the chassis are perforated to allow for proper ventilation. The components are conservatively rated.

The appearance of TX-62, the ease of operation and circuitry used are what one would expect to find in a transmitter costing much more. There is no other transmitter like it on the market!

SPECIFICATIONS AND FEATURES:

- Frequency coverage: 50-54 Mc. & 144-148 Mc.
- Power input to final: 75W. CW, 75W. peak on phone.
- Tube lineup: 6GK6—osc., tripler. 6GK6 doubler, 7868 tripler (on 2. meters) 7984—Final. 12AX7 and 6GK6 modulator.
- Crystal-controlled or can take VFO. Crystals used are inexpensive 8 Mc. type.
- Meter reads final cathode current, final grid current and RF output.
- Controls: power switch, phone-CW switch, meter, selector switch, crystal or VFO switch, audio gain control, drive control, bandswitch, final plate tuning, loading.
- Solid state power supply included, built-in.
- Mike/key jack and crystal socket on front panel. Push-to-talk mike jack.
- TVI suppressed.
- Potentiometer type drive control. Audio gain control.
- Additional connections in rear for key and relay.

Distributed by:

AMECO

AMECO EQUIPMENT CORP.
178 HERRICKS RD., MINEOLA, L. I., N. Y.
516 Pioneer 1-5030

AMECO

Amateur Gear, Accessories

MODEL TX-86 HAM BAND TRANSMITTER

Compact, versatile ham band transmitter handles 90 watts CW and phone on 6 through 80 meters. Ideal for mobile and fixed station use. Final 6146 operates straight-through on all bands. Pi-network output will feed antennas of 35 to 600 ohms. Other features include: Exclusive modulator circuit, audio gain control, potentiometer drive control (no detuning), push-to-talk mike jack, TVI filtered. Can take crystal or VFO. **Power Requirements:** 6.3 v. at 3.2 a., 12.6 v. at 1.6 a., 300 v. at 75 ma, and 600 v. at 150 ma. **Size:** 7" w. x 7" d. x 5" h.

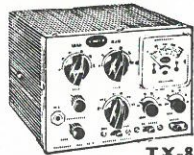

TX-86

Ameco Model TX-86K Ham Band Transmitter—Kit, \$89.95 Specify 6 or 12 v. filament, Net Each.
Ameco Model TX-86W Ham Band Transmitter—Wired and tested, Specify 6 or 12 v. filament, Net Each, \$119.95
Ameco Model W612A Mobile Supply—Wired and tested, Net Each, \$54.95
Ameco Model PS-3 Power Supply—Wired and tested, Net Each, \$44.95

NUVISTOR VHF SINGLE BAND PREAMPLIFIER

For 27 (CB), 28, 50, 144, or 220 mc. Over 20 db gain. Will improve gain and noise figure considerably. Two tuned circuits and one 6CW4 Nuvistor are used. **Noise Figure:** 2.0 db at 27 mc, 2.5 db at 50 mc, 3.0 db at 144 mc, and 4.0 db at 220 mc. **Power Required:** 110-150 v. at 8 ma and 6.3 v. at .135 a. **Ameco Model PV Nuvistor Preamplifier—Wired and tested, Specify frequency desired, Net Each, \$13.95**

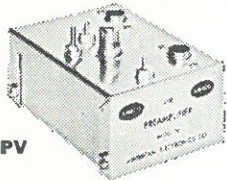

PV

HIGH FREQUENCY PREAMPLIFIER

For any band, 80, 40, 20, 15 or 10 meters. Has a better noise figure than most multiband receivers. Minimum gain is 20 db. Two tuned circuits will improve image and spurious rejection. Uses 6CB6 tube. Especially effective on 10 or 15 meters. **Ameco Model PH Preamplifier—Wired and tested, Complete with tube, Specify frequency desired, Net Ea, \$13.95**

MODEL CB TUBE TYPE CONVERTERS

Compact 2- and 6-meter converters feature low noise and high gain. IF output easily changed to any frequency to meet any possible future change of receiver. **Noise Figure:** Less than 4 db. **Gain:** Over 30 db. **IF, Image and Spurious Rejection:** Over 70 db. **Tube Complement:** 2-meter unit—6ES8 low noise Cascode first RF amp., 6U8 second RF amp./mixer and 6J6 osc./mult. 6-meter unit—6ES8 Cascode RF amp., 6U8 mixer/osc. **Power Required:** 2-meter unit—100-150 v. at 28 ma and 6.3 v. at 1.26 a. 6-meter unit—100-150 v. at 16 ma and 6.3 v. at .85 a. **Size:** 2½" w. x 5" d. x 2" h.
Ameco Model CB-6K 6-Meter Converter—Kit, Specify IF output, Net Each, \$19.95
Ameco Model CB-6W 6-Meter Converter—Wired and tested, Specify IF output, Net Each, \$27.50
Ameco Model CB-2K 2-Meter Converter—Kit, Specify IF output, Net Each, \$23.95
Ameco Model CB-2W 2-Meter Converter—Wired and tested, Specify IF output, Net Each, \$33.95



CB-6

POWER SUPPLY

Delivers 50 ma at 125 v. DC and 2 amps at 6.3 v. AC from 115 v. AC input. Plugs directly into all Ameco CN and CB units.
Ameco Model PS-1K Power Supply—Kit form, Net Each, \$10.50
Ameco Model PS-1W Power Supply—Wired and tested, Net Each, \$11.50

MODEL CN NUVISTOR CONVERTERS

Use of three Nuvistors plus one tube gives an extremely low noise figure and high gain. Will never become obsolete since the IF output is easily changed to match any receiver. Special circuit to reduce overload from strong stations. **Noise Figure:** 2.5 db at 50 mc, 3.0 db at 144 mc, 4.0 db at 220 mc. **Gain:** 45 db, average. **Image and Spurious Rejection:** Better than 70 db. **IF Rejection:** Better than 100 db. **Control:** Gain. **Power Required:** 100-150 v. at 30 ma; 6.3 v. at .84 a. **Size:** 2½" w. x 6¾" d. x 2½" h.
Ameco Model CN-50W, CN-144W, or CN-220W Nuvistor Converter—Wired and tested for any one band, using any IF output (specify), Net Each, \$49.95
Ameco Model CN-50K, CN-144K or CN-220K Nuvistor Converter—Kit, For any one band, using any IF output (specify), Net Each, \$34.95

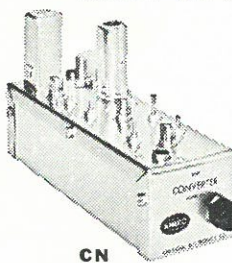

CN

CODE PRACTICE OSCILLATOR, KITS

Available in kit or wired form. Produces a pure, steady tone without clicks or chirps. Will handle a large number of headphones or keys. Converts easily to an excellent CW monitor. Variable tone control and volume control. Built-in 4" speaker. Operates on 110 volts AC or DC.
Ameco No. CPS-KL—Kit form, less tubes, Net Each, \$11.95
Ameco No. CPS-WL—Wired, less tubes, Net Each, \$13.15
Ameco No. CPS-KT—Kit, including tubes, Net Each, \$13.75
Ameco No. CPS-WT—Wired, with tubes, Net Each, \$14.95

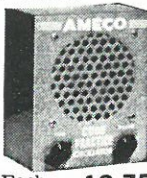

MODEL SWB STANDING WAVE BRIDGE

Reads SWR accurately from 1.8 mc to 225 mc. Handles up to 1 kw. Quality inductive coupling can be left in the line continuously without insertion loss. Contains two SO-239 VHF connectors. **Size:** 4½" w. x 1½" d. x 2¼" h.
Ameco Model SWB Standing Wave Bridge—Wired and tested, Net Each, \$9.95



MODEL BIU BRIDGE INDICATOR UNIT

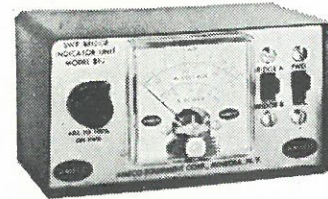

Accurately indicates SWR, % of power and % of voltage (three scales) when used with Ameco SWB or other bridge. Contains a sensitive 100 µa 2½" square d'Arsonval meter. Switching circuit provides for reading either one of two bridges. **Size:** 5" w. x 2¾" d. x 3" h.
Ameco Model BIU Bridge Indicator Unit—Wired and tested, Net Each, \$15.95

MODEL CSB CONVERTER SWITCH BOX

Makes band switching possible with several VHF converters. Four-position selector switch allows to switch any one of up to three converters or connects the receiver directly to the low band antenna. A single switch automatically switches both RF and power. Plugs directly into Ameco PS-1 power supply and Ameco Converters or any other makes. **Size:** 2½" w. x 4½" d. x 2" h.
Ameco Model CSB Converter Switch Box—Kit, Complete with all plugs and cables, Net Each, \$9.95

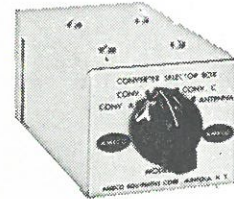

TECHNICAL BOOKS

No. 3-01 Radio-Electronics Made Simple—Simplified explanation of radio theory written for the layman's complete understanding. Covers basic electricity and all phases of radio through transmitters and receivers. 200 pages. Price Each, \$1.95
No. 5-01 Amateur License Guide—Prepares for Novice, Technician, Conditional and General classes of radio operation. Over 200 questions and answers similar to ones of FCC exams. 32 pages. Price Each, 50¢
No. 6-01 Mastering the Morse Code—Beginning study for learning International Morse Code. Includes alphabet, how to send, how to receive, hook-up of an oscillator, etc. 32 pages. Price Each, 50¢
No. 7-01 TV Antennas—Describes the various types of TV antennas and their uses. Provides information for installation and repair. Written in the layman's language. 32 pages. Price Each, 50¢
No. 8-01 Commercial Radio Operator's Q & A License Guide, Elements 1 and 2—First of a series, covers FCC exams by questions and detailed, simplified answers. Provides answers for Third Class permit. Price Each, 75¢
No. 9-01 Commercial Q & A License Guide, Element 3—Second in the series for FCC exams. Includes questions and answers plus a sample FCC exam. With Elements 1 and 2, it provides answers for Second Class permit. Price Each, \$1.75
No. 10-01 Commercial Q & A License Guide, Element 4—Covers last element required to obtain a First Class Radiotelephone license. Detailed questions and answers with a sample FCC exam. Price Each, \$1.25
No. 11-01 Transistor Theory and Circuit Made Simple—Explains both the theory and the applications of transistor in a simple straight-forward manner. Includes many practical circuits. Written for servicemen, amateurs, experimenters and engineers. 128 pages. Price Each, \$1.75

CODE AND THEORY COURSES

No. 1—Junior Code Course. Consists of 10 recordings (alphabet through 7½ W. P. M.). Includes typical FCC type code exams. Free instruction book on learning how to send and receive code the simplest, fastest way; plus charts to check your receiving accuracy; plus leatherette bound album. **\$6.95**
No. 100-01 Junior Code Course—78 rpm, Net Each, \$6.95
No. 100-45 Junior Code Course—45 rpm, Net Each, \$5.95
No. 100-33 Junior Code Course—33½ rpm, Net Each, \$4.95
No. 2—Senior Code Course. Includes everything in No. 1 course plus 12 more recordings (alphabet through 18 W. P. M.), plus typical FCC type code exams for General Class and 2nd Class Commercial telegraph licenses. Includes album. **\$11.50**
No. 101-01 Senior Code Course—78 rpm, Net Each, \$11.50
No. 101-45 Senior Code Course—45 rpm, Net Each, \$10.50
No. 101-33 Senior Code Course—33½ rpm, Net Each, \$9.50
No. 3—Complete Radio Theory Course. A complete, simplified home study theory course in radio covering the novice, technician, conditional and general classes—all under one cover—with over 400 typical FCC type questions to prepare for license examination. No technical background required. **\$3.95**
No. 102-01 Radio Amateur Theory Course—Net Each, \$3.95
No. 4—Advanced Code Course. Prepares novice operators for the amateur general class and second class commercial license tests. Contains 12 recordings (8 through 18 W. P. M.) plus a complete code book; plus typical FCC code examinations for general and commercial tests. **\$5.95**
No. 103-01 Advanced Code Course—78 rpm, Net Each, \$5.95
No. 103-45 Advanced Code Course—45 rpm, Net Each, \$4.95
No. 103-33 Advanced Code Course—33½ rpm, Net Each, \$4.95

OPERATING INSTRUCTIONS FOR AMECO TRANSMITTER, MODEL TX-62

IT IS IMPORTANT THAT THIS ENTIRE MANUAL BE READ CAREFULLY BEFORE THE TRANSMITTER IS PLUGGED INTO AN OUTLET AND BEFORE ANY OPERATING IS DONE WITH THE TRANSMITTER.

SAFETY NOTICE

Voltages of over 600 volts DC are present in the TX-62 when the unit is in operation. THESE VOLTAGES CAN BE DANGEROUS. Occasionally a few tests may have to be made inside the set with the high voltage on. NOTE that this voltage is present, whether the key is up or down. Observe all safety precautions. When it is necessary to make measurements with the power on, use only one hand. Keep the other hand in your pocket. Do not lean on the table or touch any other object.

DO NOT ATTEMPT TO MAKE ANY REPAIRS OR CHANGE TUBES WITH THE POWER ON. Disconnect the plug from the AC line before doing any work inside the transmitter.

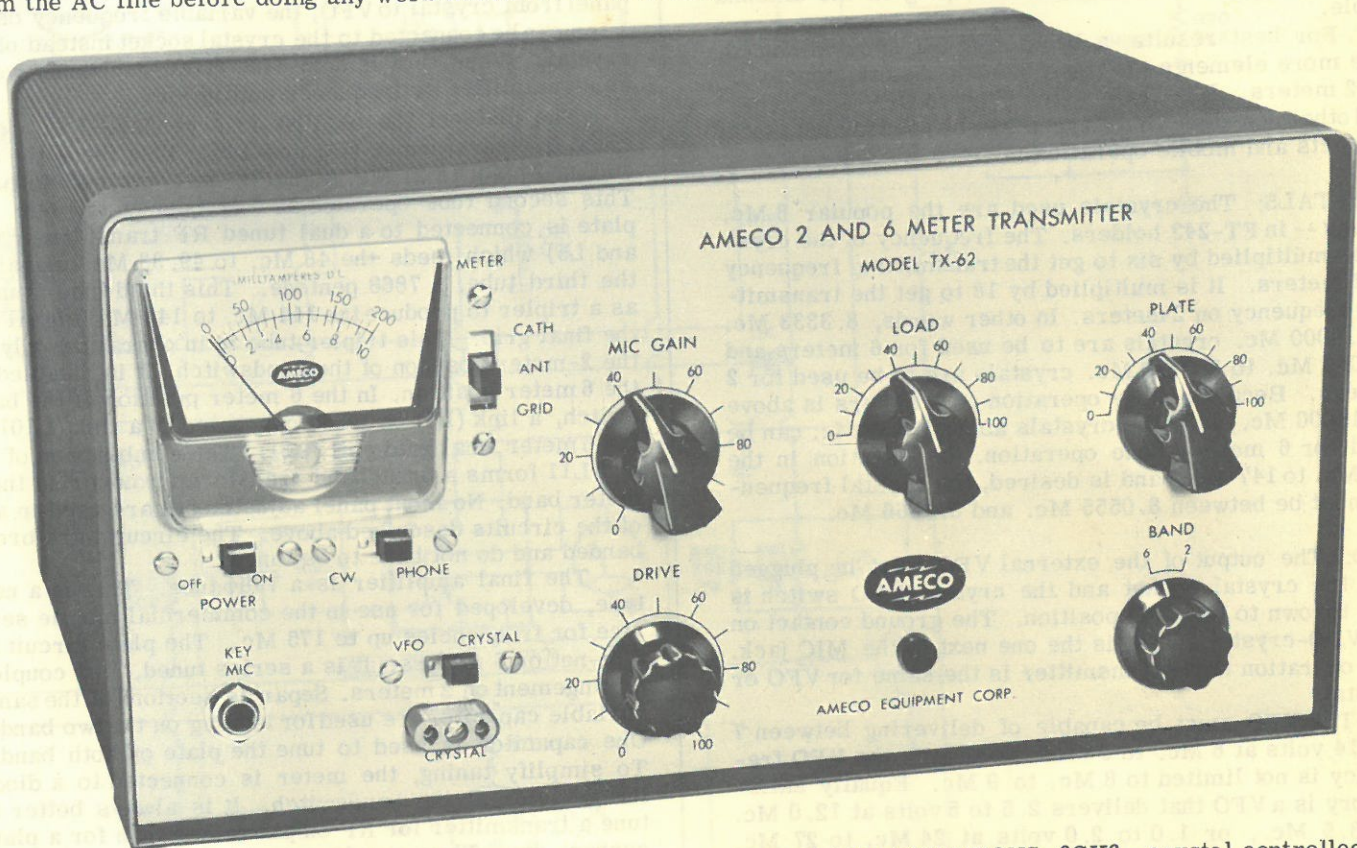

GENERAL INFORMATION

The Ameco Model TX-62 Transmitter is a compact, convenient, easy-to-operate transmitter for the 6 and 2 meter bands. The TX-62 has 75 watts input on CW and 75 watts peak input on phone. It has a built-in AC power supply and modulator. All exciter circuits are broad-banded. Only the final plate and loading capacitors have to be tuned. A potentiometer-type drive control is used to set the drive level to the final grid. The final is operated straight through on both bands.

The TX-62 uses the low distortion Ameco DUO-GRID modulation. It is NOT controlled carrier or clamp tube modulation, but a far superior system with quality that cannot be distinguished from push-pull plate modulation, even with an oscilloscope. The percentage of modulation is controlled by an audio gain control on the front panel.

SPECIFICATIONS

FREQUENCY COVERAGE: 50-54 Mc. and 144-148 Mc.

POWER INPUT TO FINAL: CW - 75 watts,
Phone - 75 watts peak

TUBES AND FUNCTIONS: 6GK6 - crystal controlled oscillator and tripler, 6GK6 - doubler, 7868 - tripler on 2 meters only, 7984 - final, 12AX7 - audio voltage amplifier and 6GK6 modulator.

FREQUENCY CONTROL: Crystal controlled, using inexpensive 8 Mc. crystals or an external VFO can be used.

METER reads final cathode current, final grid current and RF output.

CONTROLS: POWER switch; PHONE-CW switch; METER selector switch; VFO-CRYSTAL switch; MIC GAIN control and spot switch; DRIVE control; BAND switch; Final PLATE tuning; LOAD
The jack for the microphone or key and the crystal socket are on the front panel. Additional connections can be made to an octal socket on the rear of the chassis for key, relay, etc.

SIZE: 11-1/2 x 9-1/2 x 6 inches. WEIGHT: 18-1/2 lbs.

POWER: AC-117 volts, 60 cycles, 220 watts maximum. For 12 volts DC operation, a Heath MP-10 Power Supply

can be used.

ANTENNA: The TX-62 is designed to be used with 50 or 72 ohm coaxial line fed antennas. For balanced lines of 200, 300, 450 or 600 ohms, either a balun made from coaxial cable or an antenna tuner can be used. These will provide the conversion from balanced to coaxial line. See the ARRL Handbooks for details. Baluns are described in the section on Antennas (1963 page 386) and dimensions are in a table in the section on VHF Antennas (1963 page 457). An Antenna Tuner is described in the section on VHF Transmitters (1963 page 453). This data is in all the Handbooks from 1957 on.

The antenna jack is an SO-239 (83-1R) connector which requires a PL-259 (83-1SP) plug on the antenna cable.

For best results, a beam antenna should be used. The more elements the beam has, the better, especially on 2 meters. The "halo", the "big wheel", the "whip" and other non-directional types can be used for net, local contacts and mobile operation.

CRYSTALS: The crystals used are the popular 8 Mc. series -- in FT-243 holders. The frequency of the crystal is multiplied by six to get the transmitting frequency on 6 meters. It is multiplied by 18 to get the transmitting frequency on 2 meters. In other words, 8.3333 Mc. to 9.0000 Mc. crystals are to be used for 6 meters and 8.0000 Mc. to 8.2222 Mc. crystals are to be used for 2 meters. Because phone operation on 6 meters is above 50.10000 Mc., only the crystals above 8.350 Mc. can be used for 6 meter phone operation. If operation in the 145 Mc. to 147 Mc. band is desired, the crystal frequency must be between 8.0555 Mc. and 8.1666 Mc.

VFO: The output of the external VFO must be plugged into the crystal socket and the crystal-VFO switch is then thrown to the VFO position. The ground contact on the VFO-crystal socket is the one next to the MIC jack. The operation of the transmitter is the same for VFO or crystal.

The VFO must be capable of delivering between 7 and 14 volts at 8 Mc. to 9 Mc. However, the VFO frequency is not limited to 8 Mc. to 9 Mc. Equally satisfactory is a VFO that delivers 2.5 to 5 volts at 12.0 Mc. to 13.5 Mc., or 1.0 to 2.0 volts at 24 Mc. to 27 Mc. The 24 Mc. to 27 Mc. VFO is the best one to use.

MICROPHONE: Any high impedance microphone (crystal, ceramic or dynamic) can be used. The microphone is connected to the transmitter by a three-contact 1/4" diameter phone plug. Switchcraft phone plugs, Models 60, 90, 260, 269, 290 or 297 can be used. Some of these models are shielded and some are not. Shielded types are best, but no difficulty has been noted with the plastic shell plugs.

The tip of the plug is the key line, the ring is the hot side of the microphone and the sleeve is the ground. The microphone cable is attached to the plug in the following manner (See Figure 2): Connect the cable shield from the microphone cable to the sleeve of the plug. Connect the hot microphone lead of the cable to the ring of the plug. Connect the lead coming from the push-to-talk button to the tip of the plug.

No provision is made for the use of a carbon microphone.

KEY: Any key can be used for CW; --- straight, side swiper, bug or electronic. A two-contact or three-contact plug can be used. If a two-contact plug is used, con-

nect the base or ground side of the key to the sleeve of the plug and the hot side of the key to the tip of the plug. If the three-contact plug is used, connect the ring of the plug to the sleeve of the plug, in addition to the above connections.

Both the key and the microphone can be wired into the same three-contact plug at the same time for operating convenience.

CIRCUIT DESCRIPTION

The TX-62 uses a 6GK6 pentode tube as a crystal oscillator. It uses standard, inexpensive, 8 to 9 Mc. fundamental type crystals. By throwing a switch on the panel from crystal to VFO, the variable frequency oscillator can be connected to the crystal socket instead of the crystal. When this is done, the 6GK6 oscillator works as an amplifier or frequency multiplier.

The plate of the oscillator is connected to a dual tuned RF transformer (L2 and L3). This feeds the resultant 24 Mc. to 27 Mc. signal to the second 6GK6 tube. This second tube operates as a frequency doubler. Its plate is connected to a dual tuned RF transformer (L4 and L5) which feeds the 48 Mc. to 49.33 Mc. signal to the third tube, a 7868 pentode. This third tube is used as a tripler to produce the 144 Mc. to 148 Mc. signal for the final grid. This tripler tube is in operation only in the 2-meter position of the bandswitch. It is disabled in the 6 meter position. In the 6 meter position of the band switch, a link (L6) on L4 is connected to a link (L10) on the 6 meter final grid coil (L11). The combination of L4 and L11 forms a broadband transformer covering the 6 meter band. No front panel adjustments are used in any of the circuits described above. The circuits are broadband and do not have to be tuned.

The final amplifier is a 7984 tube. This is a new type, developed for use in the commercial mobile service for frequencies up to 175 Mc. The plate circuit is a pi-net on 6 meters. It is a series tuned, link coupled arrangement on 2 meters. Separate sections of the same variable capacitor are used for loading on the two bands. One capacitor is used to tune the plate on both bands. To simplify tuning, the meter is connected to a diode RF detector at the bandswitch. It is always better to tune a transmitter for RF output rather than for a plate current dip. They rarely coincide. After tuning, the plate current can always be checked.

The modulator, to the careless eye, appears to be either clamp tube or controlled carrier. It is neither. The TX-62 modulator does not sound like either type. It is clean to listen to, clean to look at on an oscilloscope and gets through when the going is rough. The first tube, a 12AX7, is used as a two-stage voltage amplifier. The second tube, a 6GK6, is the modulator. It is connected to the 7984 final screen as a Heising modulator. A proportion of the audio signal is also fed into the control grid of the 7984. With screen modulation alone, distortion increases sharply above approximately 65% modulation. When the grid is also modulated, as in the Ameco system, this distortion is reduced to a very low value permitting clean, 100% modulation with a very simple circuit. When the transmitter is operated on CW the modulator tube is reconnected as a clamp tube to protect the final in case of loss of excitation. On phone, the reduced screen voltage provides some protection for the final.

INSTALLATION

Read this entire section over carefully before doing any-

thing. Then start with step 1. Do not plug the transmitter into the AC line outlet until the instructions below tell you to do so.

1. Connect the wire from the ground terminal at the rear of the chassis to a good ground such as a cold water pipe. All other equipment such as the receiver, converters, power supplies, VFO, etc. should have good connections made to this same ground. Use a #14 or heavier wire. Do not depend on coaxial cable to provide a common ground. The RF bypass capacitors from the AC line to the chassis can give an unpleasant shock if the above grounding instructions are not followed. This is true for all makes of equipment.

2. Connect the antenna to the changeover relay or switch.

3. Connect the Standing Wave Bridge, if one is available. Instructions for this come with the Standing Wave Bridge.

4. Hook up the Low Pass Filter, if you are operating on 6 meters. A Drake TV-1000LP is recommended for this use. If you switch to 2 meters, remove the low pass filter from this circuit.

5. Connect the receive side of the relay to the converter or receiver.

6. Connect the transmit side of the relay to the coaxial jack on the back of the transmitter.

7. Connect the relay coil (See section on Relays).

8. Plug in the microphone.

9. Plug in the crystal. If a VFO is to be used, use a crystal for at least the first tests.

OPERATION FOR PHONE AND CW

1. Preset the TX-62 controls as follows: POWER switch to OFF, CW-PHONE switch to CW, VFO - CRYSTAL switch to CRYSTAL, METER switch to GRID, MIC GAIN at zero, DRIVE at 100, LOAD at zero, PLATE at about 50, BAND switch set on the band to be tuned up, Key or microphone switch should be open

2. Plug the line cord of the transmitter into the AC wall outlet.

3. Throw the power switch on. Wait for at least one full minute for the tubes to warm up.

4. Key the transmitter with the key or the button on the microphone momentarily and watch the meter. It should read between 2 and 9 ma.

5. If the meter reads above 5 ma., turn the drive control down to obtain a reading between 2 ma. and 5 ma.

6. Throw the meter switch to ANT.

7. Key the transmitter and tune the PLATE capacitor for maximum reading on the meter.

8. Key the transmitter and adjust the LOAD capacitor for maximum reading.

9. Repeat steps 7 and 8 several times until no further increase is obtained. Do NOT hold the key down for a long time. Hold it for just a few seconds at a time while each adjustment is made. During tuneup, it is very easy to overheat the final amplifier tube and shorten its life.

NOTE: Step 10 is for CW operation only. Steps 11 through 13 are for Phone Operation only.

10. (CW OPERATION ONLY) Throw the meter switch to GRID. Adjust the drive control for 3 ma. on the meter. Satisfactory results can be had with as little as 2 ma.

The transmitter is now tuned up for CW operation.

The following steps are for Phone operation only.

11. Throw the CW-PHONE switch to PHONE. Throw the METER switch to GRID. Adjust the DRIVE control for 3 ma. on the meter. Satisfactory results can be had

with as little as 2 ma.

12. Throw the METER switch to ANT. This will permit observation of the RF output to the antenna, including the variations with modulation.

13. Adjust the MIC GAIN control until the meter swings up the scale on a few words -- on peaks -- about one-quarter way between the meter reading for CW and the meter reading for Phone when there is no modulation. If the meter does not swing at all, the modulation is too low. Either talk closer to the microphone or talk louder or turn the MIC GAIN control up higher. When the swing is excessive, the modulation is also excessive, causing distortion and often poor readability. In this case, turn the MIC GAIN control down.

The transmitter is now tuned for Phone operation.

Note that in the tuneup procedures above, the plate current is not mentioned. Accurate tuning cannot be had by tuning the TX-62 for plate current dip. A typical range of meter readings on CATH, or cathode currents (the total of plate, screen and grid currents) is as follows:

	6 meters	2 meters
CW	130 - 170 ma.	150 - 190 ma.
Phone	80 - 110 ma.	90 - 135 ma.

These readings are affected by line voltage variations, antenna characteristics, tube variations and circuit variations.

On Phone, one may talk as long as desired. On CW, send CW as long as desired but do not hold the key down for more than a couple of minutes. Remember that CW is a "part time" operation - the carrier is off a good part of the time. If tests require long key-down operation on CW, tune carefully.

ALTERNATE STEP 11:

Step 11 above is rather simple and is sufficient for most operations. However, as the user becomes more familiar with the transmitter, he may want to use a better method for arriving at the proper final grid current. The final will operate with more efficiency with this alternate method. It can be done as follows:

With the METER switch on ANT. and the DRIVE control at maximum (never allow the final grid to have more than 5 ma. for more than a few seconds), adjust the DRIVE control from the maximum point downwards. As the control is turned down, the meter reading will increase and then decrease. Turn the control up again (clockwise) --- just past the peak reading to where the meter reading starts to drop very slightly. This is the best operating point. The METER switch can then be thrown to GRID. The grid current reading is usually very close to 3 ma., but it may be as low as 2 ma. or as high as 3.5 ma. Note that this procedure is good for general use, on any Class C amplifier -- for phone or CW.

SPOT SWITCH: There is a switch on the MIC GAIN control. It is normally in the "ON" position. If the MIC GAIN control is turned counter-clockwise - past 0 - the switch will snap to the "OFF" position. In this position, the final amplifier and the tripler on 2 meters are disabled. This permits keying the transmitter and tuning in the signal on the receiver, without putting a signal on to the antenna. Either the receiver can be exactly tuned to a crystal frequency or, when a VFO is used, the VFO can be tuned in exactly to the same frequency as the station the receiver is tuned in on. As soon as the tuning is completed, turn the MIC GAIN back to the original setting. Note that the use of the spot switch will depend on the relay circuit in use.

RELAYS

Circuits for the changeover from receive to transmit can have practically infinite variations. Some of the switching that may have to be done, depending on the equipment combination, is as follows:

Disable the receiver.

Transfer the antenna from the receiver to the transmitter.

Short out or otherwise protect the receiver (or converter) input from damage from energy produced by the transmitter. Open contacts on an ordinary relay or switch are no protection.

Key the transmitter.

Key the VFO.

The least expensive system is to use manually operated switches for all changes. However, after a short time, the operating clumsiness of this will become obvious. The best system is to use a relay especially made for this purpose. Two arrangements will be described in detail. The first is for phone operation only, using a microphone with a push-to-talk button. The second is for mixed phone and CW operation. Both use the Dow-Key DK60-G2C Relay with double pole double throw auxiliary contacts and a 115 volt AC coil. The AC coil of this relay works equally well on AC or DC. On DC, it operates well at 22 to 28 volts, 60 to 78 ma. It is approximately 360 ohms. The initial cost may seem high, but there is no equivalent unit on the market that will do the job. The use of the relay makes for extremely convenient operating conditions.

CONNECTING THE DOW-KEY RELAY FOR PHONE OPERATION ONLY: (SEE FIGURE 3)

A. Find a convenient place to mount the relay with two screws. Do NOT mount it directly on to the coax connector on the transmitter or in other equipment because the SO-239 coaxial connector is not made to carry any more load than a plug and flexible cable.

B. Obtain an octal male socket (Amphenol 86CP8 with a 3-12 or 3-24 cap).

C. Connect the relay coil to octal pins 4 and 5 with a good grade of flexible wire. The voltage on this cable is approximately 600 volts. Lamp cord is not good enough. Cover the relay coil terminals with electrical tape. Never handle the relay to change coaxial cable connections unless the transmitter is turned off.

D. Remove the transmitter from its cabinet. The AC line plug must be disconnected during all of the following steps.

E. Cut the jumper between pins 4 and 5 on the octal socket at the rear of the transmitter chassis.

F. Connect a 20 mfd. or larger, 150 volt electrolytic capacitor, negative to pin 5 and connect the positive end to pin 4 of the octal socket.

G. Connect a 1000 ohm, 25 watt wire wound resistor (Ohmite Stock #0205, Ward Leonard #25 F 1000 ohm, etc.), across the same two terminals (4 and 5) of the socket. Do not support the resistor by solder joints. Mount it properly and keep it away from the other components. There are two holes at the rear of the chassis between the antenna jack and the octal socket to mount this resistor.

H. Connect the auxiliary contacts of the relay as described below to provide receiver muting (and keying for the VFO, if desired). See Figure 3.

1. Connect the center terminal of one set of SPDT contacts to the common ground line of all the equipment.

2. Disconnect the lead that connects the speaker to the grounded audio terminal on the receiver.

3. Connect the terminal of the normally closed contact to the speaker terminal that was just disconnected.

4. Do not disturb the other side of the speaker that is connected to the hot audio output terminal on the receiver.

5. Connect a resistor across the output audio terminals of the receiver. If the speaker impedance is 3.2 or 4 ohms, use a 10 ohm, one watt resistor. If it is a high impedance speaker (4,000 ohms is typical), use a 10,000 ohm, one watt resistor.

6. Connect the normally open contact to the key terminal of the VFO, if one is used.

I. Connect the transmitter to the relay with a short piece of coaxial cable of the same type used in the lead-in from the antenna. Use a PL-259 plug on each end of the cable. A filter, antenna tuner and/or SWR bridge can be connected between the transmitter and the relay, if desired.

J. Connect the relay to the receiver or converter using the same type of cable. Use a PL-259 plug on one end and a connector that will mate with the other unit at the other end.

K. Connect the antenna to the relay with another PL-259 plug.

In this arrangement, the other set of SPDT contacts is not used. When the relay is connected in this way, the changeover from receive to transmit is completed by operating the push-to-talk button on the microphone.

Note that there is no mention of breaking a B+ or cathode line or other disabling of the receiver or converter. There is no benefit to be derived from this kind of switching. There is a definite advantage in having this circuit operating. With the receiver in full operation, except for the broken speaker line and the very high loss between the antenna and the converter or receiver input, the receiver can be used to check the signal from the transmitter.

If the headphones are plugged into the receiver, it is possible to monitor the transmitter for distortion, drift, frequency modulation, hum, etc.

Whenever the plug is removed from the octal socket, another plug should be substituted to prevent damage if the transmitter is operated without a Dow-Key relay coil in the circuit. Use an identical octal plug and cap assembly with a jumper wire between pins 4 and 5.

To change over to CW, pull out the relay plug and insert the jumper plug in the octal socket. Connect the relay coil to the AC line through a foot switch or toggle switch. Then plug a telegraph key into the key jack on the front panel. The transmitter is then ready for CW operation.

CONNECTING THE DOW-KEY RELAY FOR MIXED PHONE AND CW OPERATION: (SEE FIGURE 4)

A. Follow step A given above for phone operation.

B. Obtain a foot switch (such as the type used to control photographic enlargers), or if preferred, a toggle switch can be used.

C. Connect a piece of lamp cord (zip cord) to the relay coil terminals and tape them up. Put a male plug on the other end if a foot switch is to be used, or run the wire directly to the toggle switch and AC line.

D. Follow the instructions for phone operation, H-1, H-2, H-3, H-4, H-5 and H-6.

E. Obtain an octal male plug (Amphenol 86CP8 with a 3-12 or 3-24 cap).

F. Connect the center terminal of the other set of

the SPDT auxiliary contacts to pin 8 of the octal male plug. Connect the normally open contact to the hot terminal of the telegraph key. Do not connect anything to the third auxiliary contact. Connect the ground side of the telegraph key to pin one of the octal plug. Note that it is necessary to have a key with a shorting lever on it or, it will be necessary to add a switch across the key.

G. The microphone plugs into the MIC jack on the panel as usual. If the microphone has a push-to-talk button that disconnects or shorts the microphone, the button will have to be locked in the TALK position or the contacts should be disconnected. The key contacts must not be connected to the microphone plug.

H. Insert the octal plug into the socket at the rear of the transmitter.

I. Follow steps I, J and K given above for phone operation.

To operate with this arrangement, all that is necessary to change from transmit to receive is to step on the foot switch or operate the toggle switch. If the transmission is to be on CW, the shorting lever on the key must be open. It must be closed for phone operation.

ALIGNMENT

The TX-62 has a number of broadband circuits to eliminate the need for several panel adjustments usually found on this type of equipment. An additional advantage of the broadband circuits is the reduction of spurious outputs. This is because there are two tuned circuits used where there is usually only one, giving better attenuation of the unwanted harmonics in the multiplier stages.

These circuits are not likely to require any adjustment unless they have been tampered with or, if a special frequency range is needed.

The normal alignment gives satisfactory drive to the final over the whole 2 meter band and from 50 to 52 Mc. on the 6 meter band. There are two reasons for tuning for 2 instead of 4 Mc. on 6 meters. First, there is very little activity above 52 Mc., even in good band openings. Second, it permits slightly better attenuation of spurious signals. Data is given later for 50 to 54 Mc. alignment.

EQUIPMENT REQUIRED:

1. A variable frequency oscillator with accurate frequency calibrations having a frequency spread of 7.5 Mc. to 9.5 Mc. with at least 7 volts output. A similar instrument having a frequency spread of 22.5 Mc. to 28.5 Mc. with at least 1.0 volt output will also do.
2. A vacuum tube voltmeter.
3. A tuning wrench with 0.100" hex on both ends.
4. A 50 ohm dummy load.
5. A telegraph key with a shorting lever and phone plug.

ALIGNMENT PROCEDURE: (SEE FIGURES 5 AND 6)

1. Disconnect the blue wire from R42 - the 15,000 ohm wire wound resistor.
2. Connect the VFO to the crystal socket of the transmitter. The grounded side of the socket is nearest to the MIC jack.
3. Connect the dummy load to the antenna jack of the transmitter.
4. Plug in the key.
5. Preset the controls on the transmitter as follows: POWER switch to OFF, PHONE-CW switch to CW, VFO-CRYSTAL switch to VFO, METER selector switch to GRID, MIC GAIN control completely counter clockwise to "Spot" position. DRIVE control near maximum. BAND switch to 6 meters. PLATE and LOAD adjust-

ments will be given later on.

6. Turn the transmitter on and allow it to warm up for a full minute.

7. With the VTVM on the 50 or 100 volt DC scale, connect it to the transmitter — the common or ground lead to the chassis (for all tests) and the hot probe to the L3 - 100K junction.

8. Key the transmitter and tune the cores in L2 and L3 for maximum reading with the VFO set at 8.33 Mc. (25.0 Mc.). The first setting (8.33 Mc.) is for a 7.5 Mc. to 9.5 Mc. VFO; The figure in the parenthesis is for a 22.5 Mc. to 28.5 Mc. VFO. If the maximum voltage is less than 60 volts, check the VFO to see that it is delivering sufficient output. Also, check V1 and the voltages on its socket with the voltage chart. If the voltage reading is satisfactory, continue with the alignment.

9. Readjust the cores in L2 and L3 until the VTVM reading is over 35 volts in the VFO range from 8.0 Mc. (24.0 Mc.) to 8.67 Mc. (26.0 Mc.). Typical readings are 80 volts at 8.0 Mc. (24.0 Mc.), 50 volts at 8.33 Mc. (25.0 Mc.) and 90 volts at 8.67 Mc. (26.0 Mc.). There is normally a dip in the middle and a sharp drop above 8.67 Mc. (26.0 Mc.).

10. Shift the VTVM probe to the L5 - R13 junction.

11. Turn the MIC GAIN control away from "Spot".

12. At 8.33 Mc. (25.0 Mc.) tune L4 and L11 for maximum reading on the TRANSMITTER meter — but do not allow this reading to exceed 5 ma. for more than a few seconds.

13. Turn the BAND switch to 2 meters.

14. Tune L5 for maximum VTVM reading at 8.0 Mc. (24.0 Mc.).

15. Turn the BAND switch to 6 meters.

16. Adjust L4 and L11 to get as flat or even a reading as possible on the transmitter meter over the 8.33 Mc. (25.0 Mc.) to 8.67 Mc. (26.0 Mc.) range. Typical grid current is 6 to 9 ma. with the drive control at maximum. Do not permit the grid current to exceed 5 ma. for more than a few seconds.

17. Turn the BAND switch to 2 meters.

18. Disconnect the VTVM.

19. Adjust the core in L5 and adjust the spacing of the turns on L8 to obtain the maximum transmitter meter reading at approximately mid band. Then adjust these two until the meter reads about the same at the two ends of the band. If only a portion of the band is used, use the limits of the part you use instead of the ends of the band. The ends of the band are 8.0 Mc. (24.0 Mc.) and 8.22 Mc. (24.67 Mc.). The center is 8.11 Mc. (24.33 Mc.).

20. Turn the power off and reconnect the blue wire to R42. Turn the power on and allow at least a full minute for warm-up.

21. Check out the transmitter on the dummy load, using the normal operating instructions.

22. Repeat Step 19 only.

ALIGNMENT FOR 50-54 MC. OPERATION

The TX-62 is normally aligned for 50-52 Mc. operation. If service is desired over the entire 50 to 54 Mc. band, the following alignment procedure should be used. The coupling between L2 and L3 must be increased to permit the larger bandwidth. Solder a piece of plastic covered hookup wire — about 1-1/2" long — to each end of C8. Be sure that the free ends of the two wires are covered with their insulation. Twist these two wires together in one turn -- not too tight -- to form an easily adjusted small capacitor. Follow the first part of the alignment instructions above for L2 and L3, but work for the wider bandwidth desired. Try several adjustments on the twisted wire capacitor, readjusting after each

change, until the output is satisfactory. The reading will be lower, especially in the middle of the band. Do not readjust L4 or L5. L11 can be used to even up the drive on 6 meters. If the peak at 8.0 Mc. (24.0 Mc.) is kept high, the two meter drive will not be affected much, but it should be checked at the high end of the band.

SERVICE DATA

No matter how well equipment is designed and manufactured, defects are bound to occur. The purpose of this section is to correct these defects as easily as possible.

In case of any difficulty, the first step is to determine definitely that a defective condition exists. If the transmitter or the equipment connected to it is not operated correctly, certain indications of trouble might be presented when there is actually nothing wrong. The operator must be thoroughly familiar with the operating procedures, before attempting to shoot trouble.

After a positive determination is made that the transmitter has a fault, the first step is to localize the fault. Once the trouble is narrowed down to a single tube or circuit, the faulty part is quite simple to identify.

With the Trouble Shooting Data Chart, Voltage and Resistance Data (Tables), localizing trouble becomes relatively simple.

TROUBLE SHOOTING DATA

SYMPTOMS AND POSSIBLE CAUSES:

1. Transmitter will not operate when AC power is applied. Pilot light will not light.
 - a. Defective 5 amp. fuse.
 - b. Poor contact at AC outlet.
 - c. Defective POWER switch.
 - d. Open high voltage rectifier diodes.
 - e. Open 20 ohm wire wound resistor.
2. Fuse blows.
 - a. Wrong size fuse. Use 5 amp. 3AG fuse.
 - b. Short in high voltage circuits:
Rectifier diode or diodes D2, D3.
Filter capacitors C48, C49.
Bypass capacitors or coupling capacitors C27, C28, C29.
Wiring shorts.
 - c. Power transformer shorted or burned.
 - d. Shorted tube: 7984, 7868.
3. No final cathode current reading on meter.
 - a. Key not connected or not operated.
 - b. Meter open
 - c. Meter switch not making contact. See that it can move freely to all 3 positions without being stopped by the panel. If it doesn't move freely, loosen mounting screws and reset the switch.
 - d. No high voltage. See 1d, 1e.
 - e. Defective tube 7984.
 - f. Open RF choke L12.
 - g. Either jumper on octal socket (on rear) cut.
 - h. R39 open.
4. No final grid current reading on meter.
 - a. 1d, 1e, 3a, 3b, 3c, 3e, 3g.
 - b. Defective crystal, no crystal plugged in.
 - c. VFO turned off or defective.
 - d. VFO-CRYSTAL switch in the wrong position.
 - e. Any defective part or tube in the V1, V2, V3, V4 circuits. Check voltages.

5. Insufficient or drooping grid current reading on the meter.
 - a. Defective crystal or VFO with insufficient output.
 - b. Weak tube V1, V2 or V3.
 - c. Alignment poor or tampered with.
 - d. Drive control too high for the particular combination of crystal or VFO and the tubes V1 or V2.
6. Final PLATE and LOAD tuning unsatisfactory.
 - a. Antenna has a high standing wave ratio (SWR). Check it with an SWR bridge.
 - b. Antenna disconnected.
 - c. Antenna relay not working or not connected properly.
 - d. Wrong filter connected in the antenna line for the band in use.
7. No ANT reading on meter. Other readings normal, signals getting out O. K.
 - a. 3c.
 - b. Defective part: D1, R20, C32.
 - c. Wiring short or break.
8. No change in METER readings when switching from CW to PHONE.
 - a. Defective V6, R34, D5, S4.
9. No modulation.
 - a. 8a.
 - b. Defective microphone or microphone cable.
 - c. Incorrectly wired microphone plug.
 - d. Wiring or part defect in V5-V6 circuits.
10. Hum in modulation.
 - a. Unshielded or incorrectly connected microphone cable.
 - b. Defective C49.
 - c. V5 defective.
11. Distortion, squeal or overmodulation.
 - a. Defective V5.
 - b. 10a, 9b, 9c.
 - c. Receiver not properly muted during transmission.
 - d. Defective C36, C40.
12. Smoke.
 - a. Turn off power, turn transmitter over quickly and try to locate the source of the smoke. Use a strong light if possible. This is the easiest trouble to find. Replace the damaged part. Locate the cause and correct it. The burned part is seldom the faulty one. Use the resistance chart to help locate the trouble.
13. Do not disturb any tuning adjustments when shooting trouble unless absolutely necessary. Unnecessary tuning is one of the best ways to make more trouble.

NOTES FOR THE VOLTAGE AND RESISTANCE TABLE:

The measurements are made with a vacuum tube volt meter (VTVM) with 11 megohms of input resistance on DC volts. The AC line voltage should be 117 volts at 60 cycles. The readings are typical, average and subject to variations from differences in line voltage, tubes, test frequency, alignment and antenna or dummy load. All measurements are made from the point indicated to the transmitter chassis or ground.

OHMMETER POLARITY: Diodes are used in the solid state power supply, as well as in the modulator and final stages. These diodes cause some of the ohmmeter readings to be different when the ohmmeter polarity is reversed. Therefore, if the ohmmeter reading is somewhat different (possibly lower) from the value given in the chart, change the polarity of the ohmmeter leads. If there is no trouble at this point, the reading should be the same as that given in the chart.

The controls are set as follows:

POWER to ON
VFO-CRYSTAL to CRYSTAL
MIC GAIN at zero
PLATE and LOAD are tuned normally
CW-PHONE, BAND and METER switches are set as needed in testing.

* Indicates that the measurement is made with a 470K 1/2 watt resistor in series with the VTVM probe tip and the point listed.

@ Indicates that the reading can vary considerably.

The filament voltages are as follows:

V1, V2, V3 and V6	Pin 4 - 6.4 volts AC
V4	Pin 12 - 13.5 volts AC.
V5	Pin 9 - 6.4 volts AC.

WARRANTY POLICY

The Ameco Equipment Corp. warrants its equipment, when properly registered, against defects in workmanship, materials and construction under normal use and service for a period of ninety days from the date of original purchase. Under this warranty, our obligation is limited to repairing or replacing any defective parts. This warranty does not apply to any equipment which has been tampered with in any way, or which has been misused or damaged by accident or negligence.

This warranty is valid only when the enclosed card is properly filled in and returned within ten days from purchase date. The Ameco Equipment Corp. reserves the right to discontinue or change, at any time, specifications, design or prices without notice and without incurring obligations. Do not send equipment to the factory without first securing authorization to do so. This warranty does not include transportation costs to and from the factory.

AMECO EQUIPMENT CORP.
178 Herricks Road
Mineola, L. I., New York 11501

VOLTAGE-RESISTANCE CHART OF TX-62

Voltages are given in volts; Resistance values are in ohms. K indicates X 1,000; M indicates X 1,000,000.
 V = Voltage. R = Resistance. See Notes on Page 7.

Tube	Pin No.	V or R	6 METERS				2 METERS			
			C W		PHONE		C W		PHONE	
			Key Down	Key Up	Key Down	Key Up	Key Down	Key Up	Key Down	Key Up
V1	1	V*	2.5	26	2.5	85	2.5	35	2.5	85
		R	200	∞	200	∞	200	∞	200	∞
	2	V*	-4	0	-4	0	-4.4	0	-4.4	0
		R	4.7K	4.7K	4.7K	4.7K	4.7K	4.7K	4.7K	4.7K
	7	V	285	340	295	355	260	330	280	350
		R	33K	33K	72K	72K	33K	33K	72K	72K
	8	V	80	112	83	120	75	115	78	120
		R	20K	20K	20K	20K	20K	20K	20K	20K
V2	1	V	@2.5	@20	@2.5	85	@2.2	@35	@2.2	85
		R	150	∞	150	∞	150	∞	150	∞
	2	V*	@-80	0	@-80	0	@-80	0	@-80	0
		R	100K	100K	100K	100K	100K	100K	100K	100K
	7	V	285	340	295	355	265	340	280	355
		R	33K	33K	72K	72K	33K	33K	72K	72K
	8	V	10 to 250, depending on setting of drive control - - - - -							
		R	1K to 26K, depending on setting of drive control - - - - -							
V3	3	V	@108	34	@100	35	12	35	12	85
		R	∞	∞	∞	∞	150	∞	150	∞
	2,6	V	0	0	0	0	72	0	46	0
		R	22K	22K	22K	22K	22K	22K	22K	22K
	1,7	V	260	280	270	315	260	330	275	350
		R	33K	33K	72K	72K	33K	33K	72K	72K
	9	V	295	340	305	355	280	340	290	355
		R	33K	33K	72K	72K	33K	33K	72K	72K
V4	2,6,8,9	V	17	26	11	85	18	35	12	85
		R	100	∞	100	∞	100	∞	100	∞
	10	V	25	0	25	0	25	0	25	0
		R	8.2K	8.2K	8.2K	8.2K	8.2K	8.2K	8.2K	8.2K
	7,11	V	200	23	125	355	210	21	115	355
		R	130K	130K	130K	130K	130K	130K	130K	130K
	3,4,5	V	520	590	540	620	500	600	530	630
		R	130K	130K	170K	170K	130K	130K	170K	170K
V5a	6	V	230	230	230	230	230	230	230	230
		R	800K	800K	800K	800K	800K	800K	800K	800K
	7	V	-0.8	-0.8	-0.8	-0.8	-0.8	-0.8	-0.8	-0.8
		R	5.6M	5.6M	5.6M	5.6M	5.6M	5.6M	5.6M	5.6M
	8	V	0	0	0	0	0	0	0	0
		R	0	0	0	0	0	0	0	0
V5b	1	V	270	310	100	105	255	310	90	310
		R	350K	350K	350K	350K	350K	350K	350K	350K
	2	V	0	0	-0.8	-0.8	0	0	-0.8	-0.8
		R	5.6M	5.6M	5.6M	5.6M	5.6M	5.6M	5.6M	5.6M
	3	V	7	7	0	0	7	7	0	0
		R	∞	∞	0	0	∞	∞	0	0
V6	1	V	0	0	9	27	0	0	9	27
		R	0	0	@	@	0	0	@	@
	2	V	0	0	0	0	0	0	0	0
		R	570K	570K	470K	470K	570K	570K	470K	470K
	7	V	400	23	180	520	390	21	180	510
		R	130K	130K	180K	180K	130K	130K	180K	180K
	8	V	205	120	260	350	190	125	240	355
		R	30K	30K	90K	90K	30K	30K	90K	90K
Octal-Socket On Rear	2,3	V	295	340	305	355	280	340	290	355
		R	33K	33K	72K	72K	33K	33K	72K	72K
	4,5	V	520	590	540	620	500	600	530	630
		R	130K	130K	170K	170K	130K	130K	170K	170K

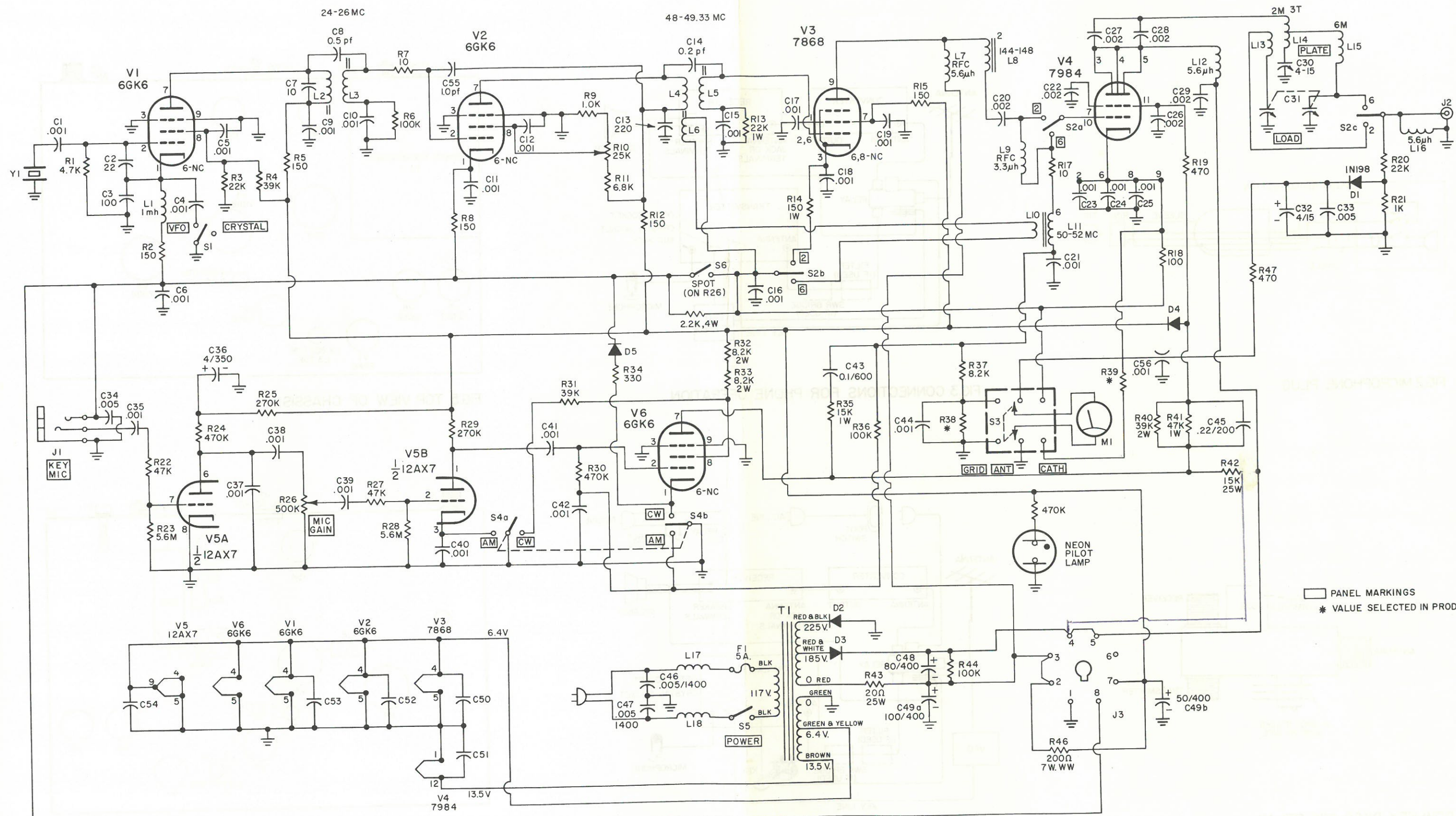

□ PANEL MARKINGS
 * VALUE SELECTED IN PRODUCTION

AMECO MODEL TX-62 TRANSMITTER

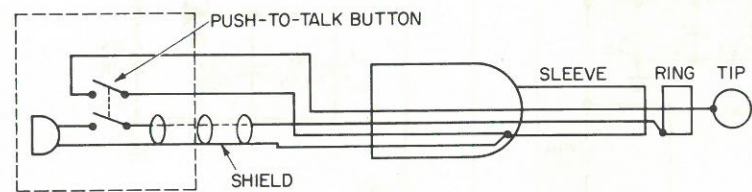

FIG.2 MICROPHONE PLUG

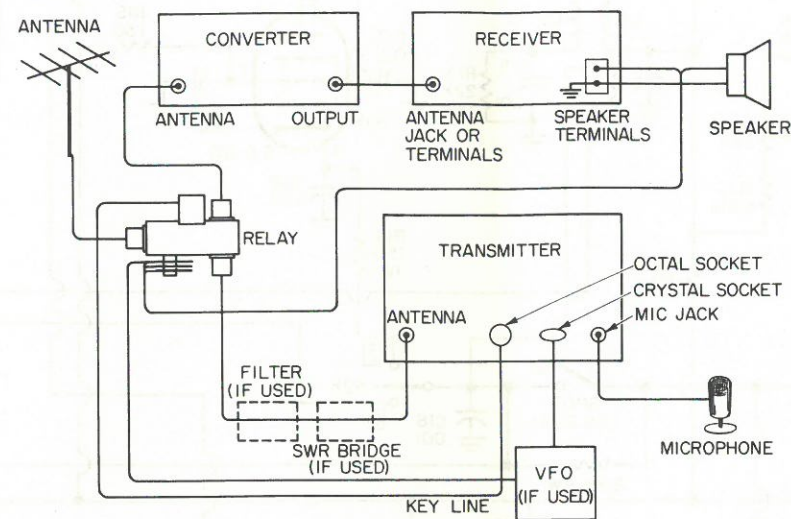

FIG.3 CONNECTIONS FOR PHONE OPERATION

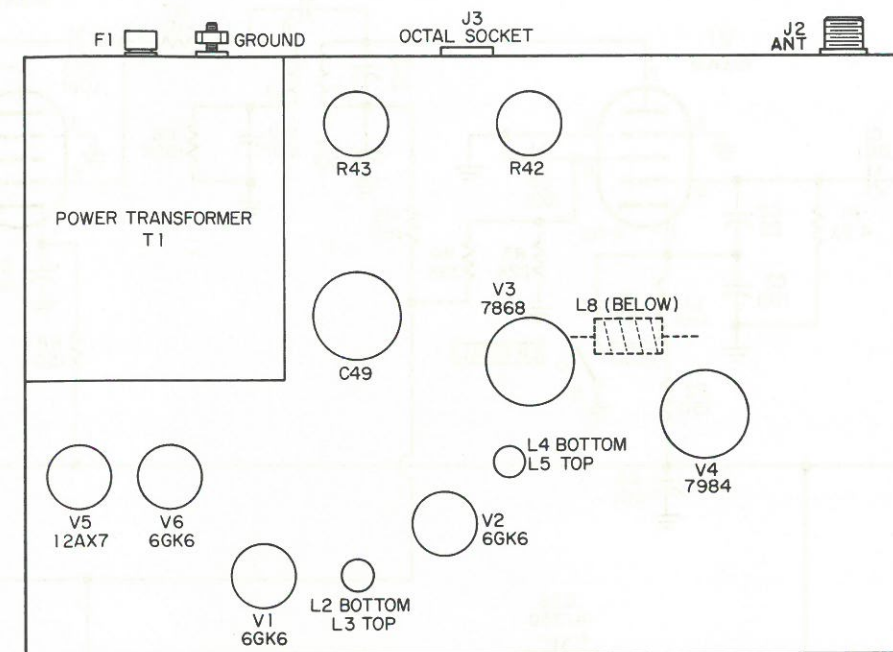
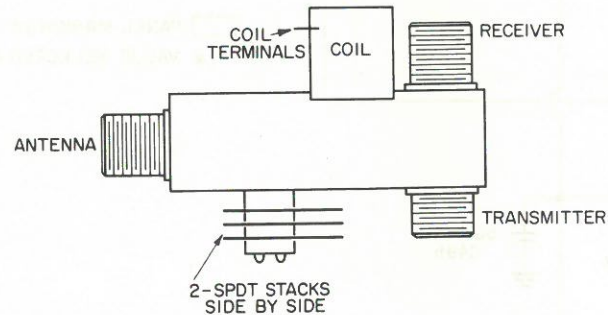

FIG.5 TOP VIEW OF CHASSIS



DOW-KEY DK60-G2C RELAY

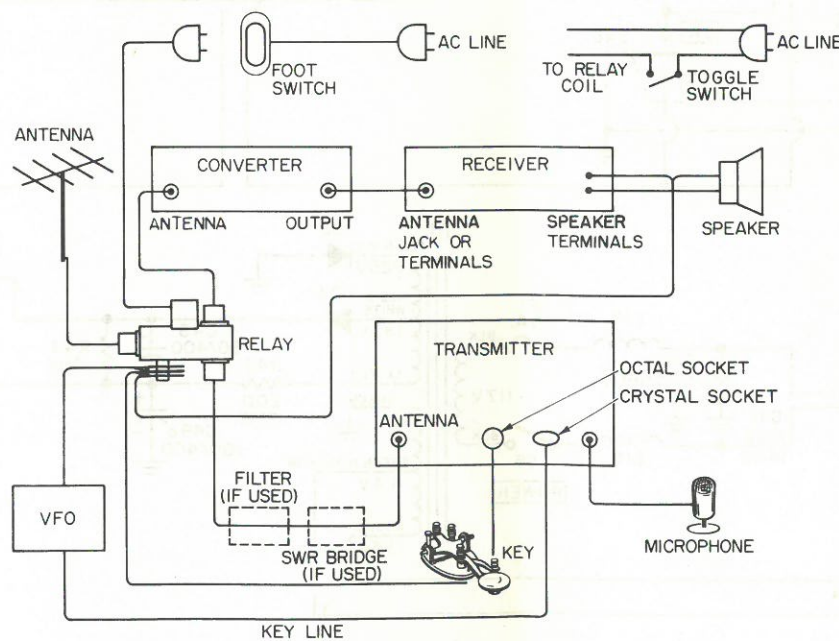

FIG.4 CONNECTIONS FOR PHONE AND CW OPERATION

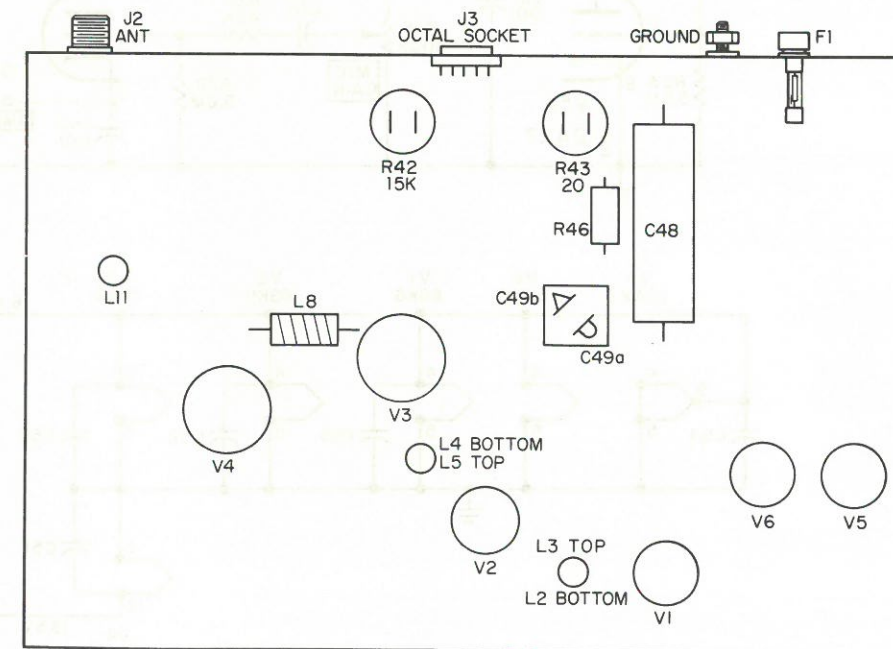

FIG.6 BOTTOM VIEW OF CHASSIS