

AMP
AMP INCORPORATED
HARRISBURG, PA 17105

IS 9863

TOOLING ASSISTANCE 1 800 722-1111
AMP FAX/ PRODUCT INFO 1 800 522-6752

RELEASED
16 NOV 92

SMA CONNECTOR

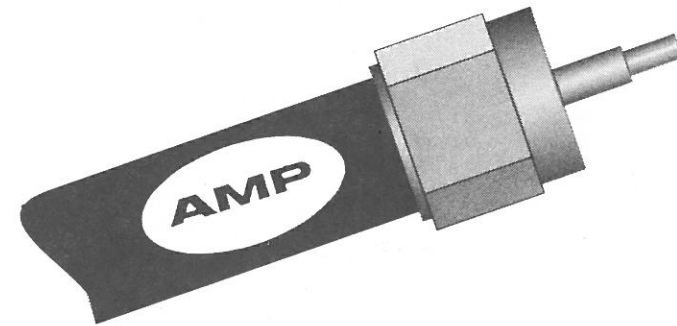

FIBER CABLE TERMINATION INSTRUCTIONS

At Your Service

AMP* Product Information Center is available to answer specific questions or resolve problems pertaining to these instructions or product use, Monday through Friday (except Holidays) 8:30 AM to 5:30 PM.

AMP Product Information Center

1-800 522-6752

AMP Document No: IS 9863

Copyright 1992 by AMP Incorporated, Harrisburg, PA
All International Rights Reserved.

PROPER USE GUIDELINES:

Cumulative Trauma Disorders can result from the prolonged use of manually powered hand tools. AMP hand tools are intended for occasional use and low volume applications. AMP offers a wide selection of powered application equipment for extended-use, production operations.

*Trademark of AMP Incorporated.

SMA Connector

SMA 905 Series

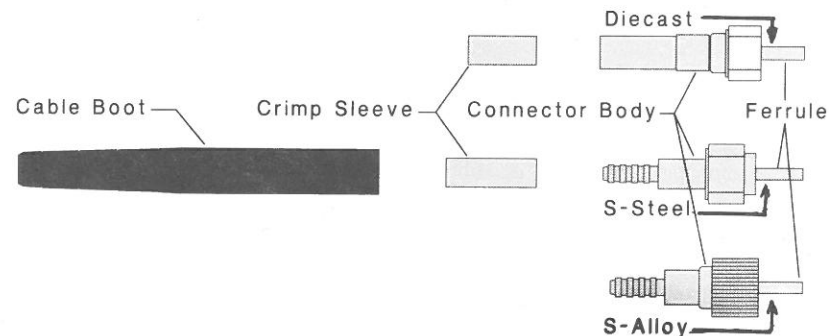

SMA 906 Series

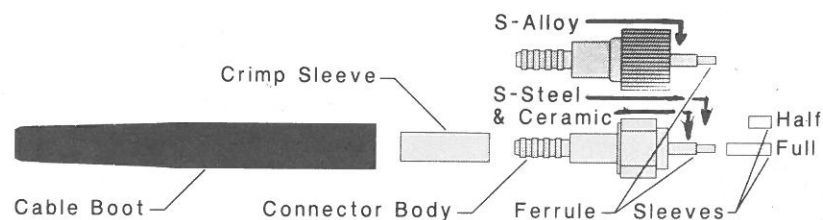

INTRODUCTION

AMP's SMA Series fiber optic connectors are available with stainless steel, stainless alloy or zinc diecast ferrules in 905 style and stainless steel, stainless alloy or ceramic ferrules in 906 style. AMP's SMAs provide full form, fit, and functionality with all standard SMA connectors and adapters.

APPLICABILITY

These termination instructions are applicable only to AMP SMA ceramic or metal fiber optic connectors. For terminating buffered fibers (unjacketed) refer to the "Unjacketed Fiber Notes" on the last page.

Fiber Preparation

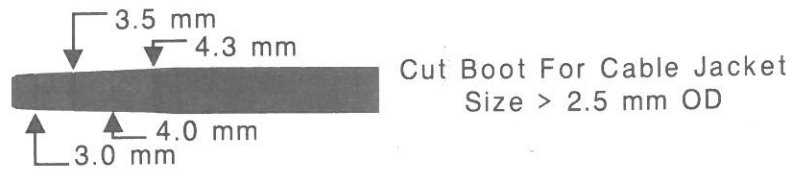

- 1 For cable jackets greater than 2.5 mm OD, cut the boot at the appropriate segments indicated above.

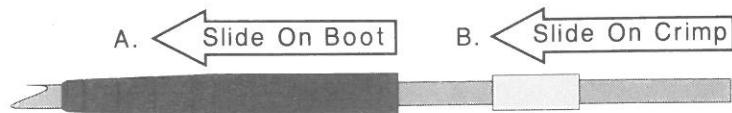

- 2 Slide the cable boot onto the cable, then slide on the Crimp Sleeve.

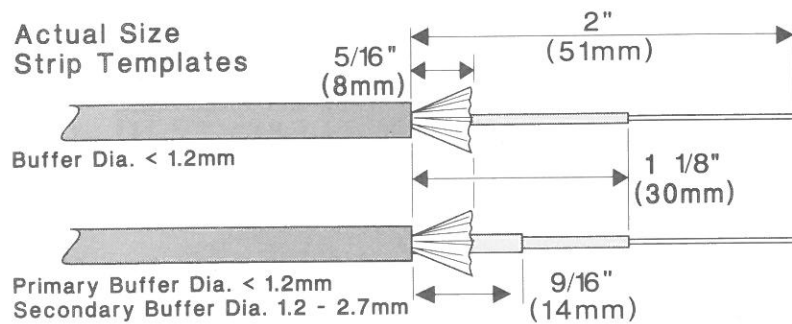

Strip Templates for 905 & 906 Stainless Ferrule SMAs

- 3 Strip off the cable jacket using #16 wire strippers (AMP Part No. 504060-1 or equivalent), trim the strength member back with sharp scissors (AMP Part No. 504063-1 or equivalent), and strip the buffer off the fiber using the dimensions in the templates above and on the following page.

Fiber Preparation

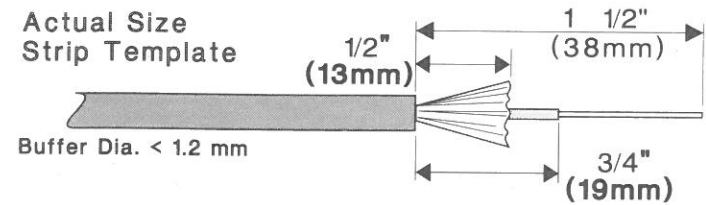

Strip Template for 905 Zinc Diecast Ferrule SMAs

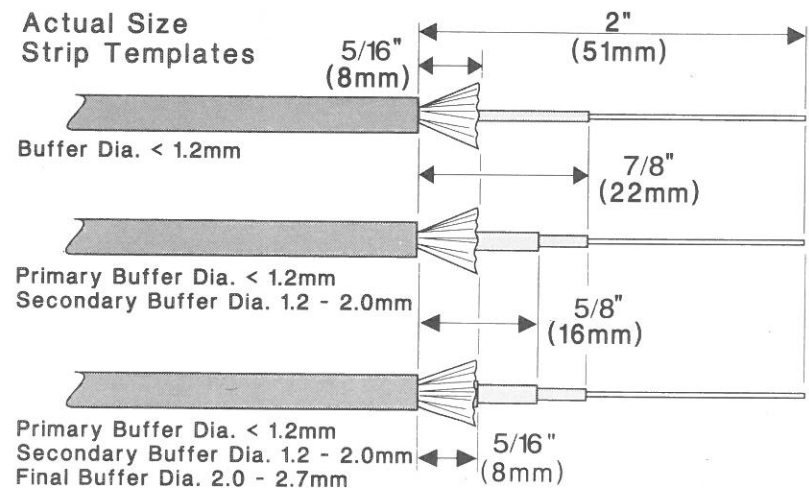

Strip Templates for 906 Ceramic Ferrule SMAs

- 4 Wipe off the stripped fiber with a lintless tissue (AMP Part No. 504440-1 or equivalent) dampened with alcohol to remove debris.

Fiber Termination

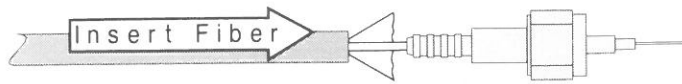

- 1 Test feed the fiber into the Connector Body by holding the buffer while slowly rotating the connector. Carefully remove the fiber after verifying fit.

NOTE Bare fiber should protrude from the ferrule. If not, the fiber has broken or was prepared improperly. Remove any broken fiber pieces and prepare it again.

- 2 Mix the epoxy (AMP Part No. 504035-1 recommended) following the manufacturer's instructions and load it into a Syringe (AMP Part No. 504043-1 or equivalent) or a metered epoxy dispenser set at 2 DIV (0.02 ML) (AMP Part No. 504042-1).

NOTE An alternative to the Syringe or the metered epoxy dispenser is coating the bare fiber with epoxy prior to inserting it into the connector body. Skip Step 3 if this method is used.

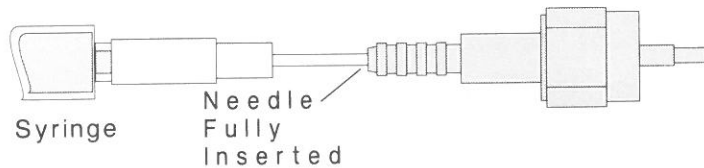

- 3 Insert the Syringe needle into the Connector Body until it stops. Dispense a small amount of epoxy. A small bead of epoxy will be forced out the ferrule's fiber hole when enough epoxy has been injected. Pull the needle back about 1/2 inch (12 mm) and dispense another small amount of epoxy. Remove the Syringe needle.

Fiber Termination (Except Zinc)

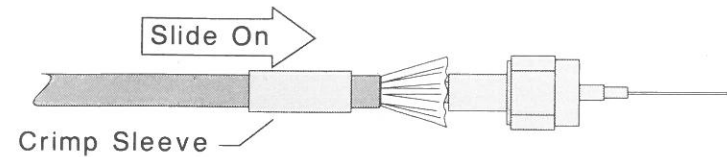

- 4 Insert the fiber into the Connector Body following Step 1 until it stops, spreading the strength member evenly around the back end of the Connector Body. Then slide the Crimp Sleeve over the strength member and connector back.

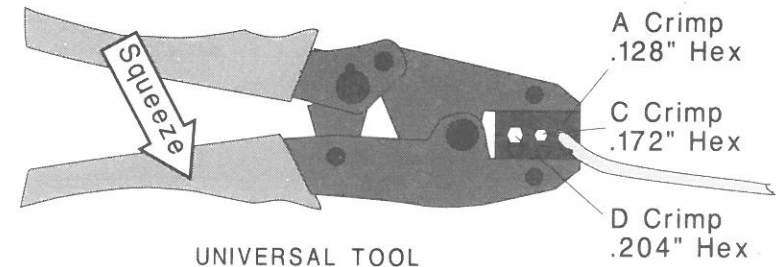

- 5 Using the Universal Crimp Tool (AMP Part No. 504105-1) or the appropriate Crimp Tool (either the 047 [AMP Part No. 504058-1] or the 048 [AMP Part No. 504059-1], see chart below), place the proper crimp cavity around the Crimp Sleeve close to the connector body. Squeeze the handles until they release. Repeat this step, squeezing on the crimp sleeve a second time to ensure a proper crimp.
- 6 Optimally, repeat Step 5, placing the appropriate crimp cavity (see chart below) around the remaining section of the Crimp Sleeve at the cable end.

STANDARD CONNECTOR ♦		UNIVERSAL TOOL	047 TOOL	048 TOOL
WITH MAX	WITH MAX	504105-1	504058-1	504059-1
CABLE O.D.	BUFFER O.D.	CRIMP CAVITY	CRIMP CAVITY	CRIMP CAVITY
3.1 mm	1.4 mm	A	A	--
4.3 mm	2.75 mm	C	C	--
5.3 mm	3.1 mm	D	--	A
3.1 mm*	1.4 mm*	D	--	A

♦ Cable O.D. and Buffer O.D. are combined.

*For plenum cable.

Fiber Termination (Zinc only)

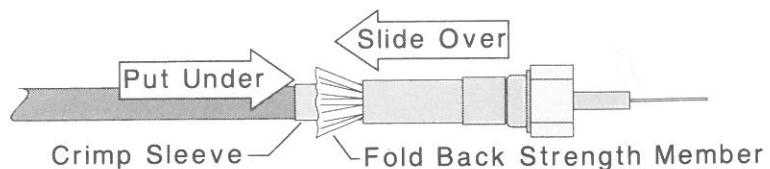

- 4 Slide the Crimp Sleeve forward to meet the cable jacket end. Then insert fiber into the Connector Body following Step 1. Slide the connector back over the Crimp Sleeve, folding back the cable strength member over the sleeve until the Crimp Sleeve is recessed about 1/8 inch (3.18 mm) into the rear of the connector.

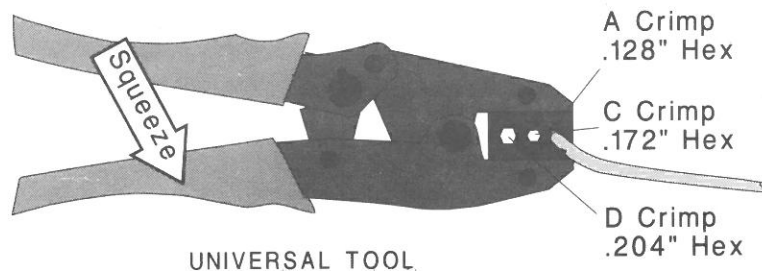

- 5 Place the Crimp Tool's (either the Universal Tool [AMP Part No. 504105-1] or the 047 Tool [AMP Part No. 504058-1]) crimp cavity "C" around the rear of the connector onto the underlying crimp sleeve. Squeeze the handles until they release.
- 6 Repeat Step 5, placing the Crimp Tool's "A" crimp cavity around a 1/8 inch (3.18 mm) section of the connector closest to the cable end.

NOTE *The second crimp prevents the crimp sleeve and strength member from pulling out of the rear of the connector under tension.*

Fiber Termination

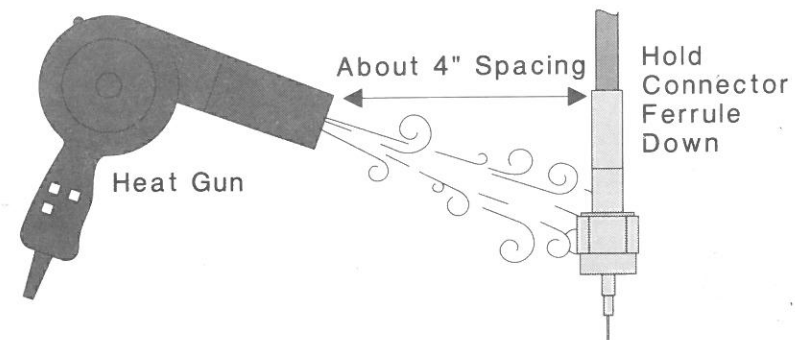

- 7 Cure the epoxy using Heat Gun (AMP Part No. 504065-1 or equivalent) about 4 inches (10 cm) from the connector, held ferrule down. Cure for 3 minutes if using AMP epoxy (Part No. 504035-1). Allow the connector to cool.

NOTE *For other epoxies, check the manufacturer's instructions for recommended curing time and temperatures. A temperature controlled oven or curing fixture may be used as an alternative to a heat gun.*

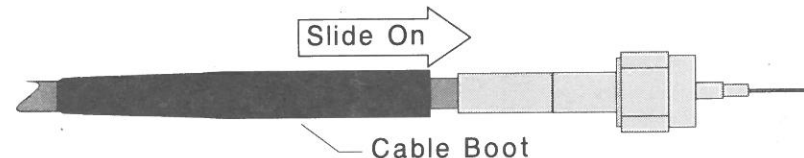

- 8 Slide the cable boot over the Crimp Sleeve to complete the assembly.

Cleaving

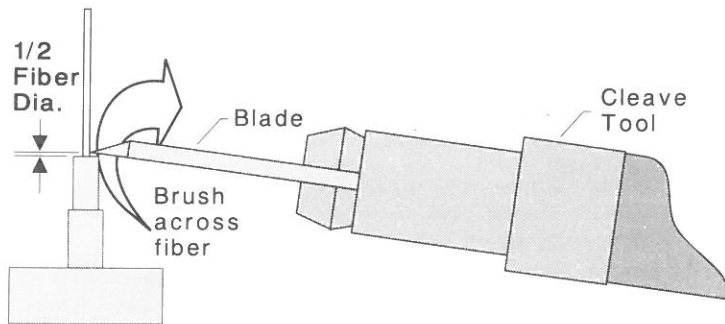

- 1 Using a Fiber Cleave Tool (AMP Part No. 504064-1 or equivalent), scribe the fiber by gently brushing the cleave tool's blade across it at a 3 - 5 degree angle, about 1/2 a fiber diameter from the connector ferrule's surface.

NOTE Do not apply force on the fiber with the cleave tool while scribing. Excessive force may fracture the fiber, making the connector useless.

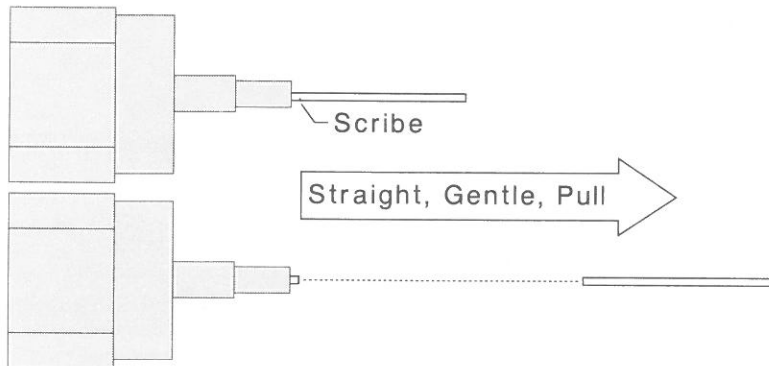

- 2 Grasp the protruding fiber and gently pull in-line with the connector. The fiber should cleave at the scribe, producing a mirror-like surface. If the fiber does not cleave easily, re-scribe the fiber and try again.

Polishing (906 Ceramic)

- 1 Clean the glass plate (AMP Part No. 504079-1 or equivalent) with water or a window cleaning solution.
- 2 Place two resilient polishing pads (AMP Part No. 504080-1) on the glass with double-sided tape. Place one piece of 0.3 micron and 3 micron polishing film (AMP Part Nos. 504078-1 and 504077-1 or equivalent) on top.

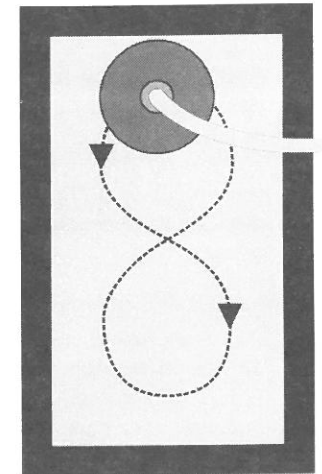
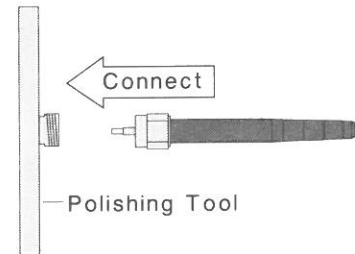
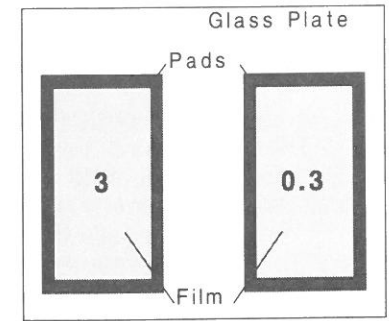

- 3 Insert the connector into the polishing tool (AMP Part No. 504072-1).
- 4 Gently place the tool on the 3 micron film and move the tool in large "figure 8" patterns, supporting the tool's weight for the first 2 or 3 "figure 8s" to prevent fiber breakage or film scoring.
- 5 Continue polishing 1 to 2 more "figure 8s" on the 3 micron film, allowing the full weight of the tool to rest on the film.
- 6 Clean the tool and connector face with a water rinse or lintless tissue dampened with alcohol. This prevents contamination of the 0.3 film with 3 micron debris.
- 7 Repeat Steps 4 and 5 with 5 to 6 "figure 8s" on the 0.3 micron film. Clean the tool and connector face following Step 6.

Polishing (Except Ceramic)

- Clean the glass plate (AMP Part No. 504079-1 or equivalent) with water or window cleaning solution.
- Place one piece of 15 micron, 3 micron, and 0.3 micron polishing film (AMP Part Nos. 504076-1, 504077-1 and 504078-1 or equivalent) on top.

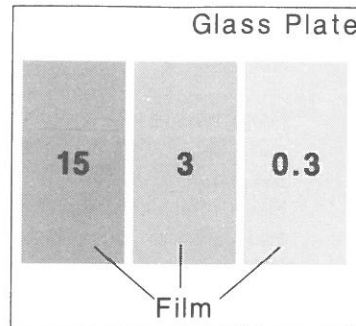

- Insert the connector into the polishing tool (AMP Part No. 504072-1).

- Gently place the tool on the 15 micron film and move the tool in large "figure 8" patterns, supporting the tool's weight for the first 2 or 3 "figure 8s" to prevent fiber breakage or film scoring.

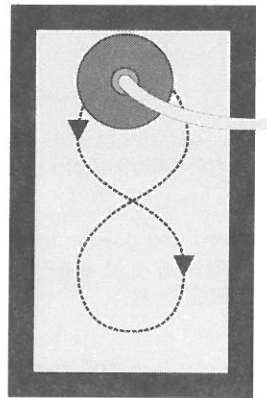

- Continue polishing "figure 8s" per the chart below, allowing the full weight of the tool to rest on the film. Chart numbers are approximate and will vary depending upon force and film usage. Length Measurement Gauges (AMP Nos. 504074-1 for 905s and 504075-1 for 906s) should be used to finish ferrule to 0.3860-0.3863 inches (9.804-9.812 mm).

Ferrule Type	No. of "Figure 8s" per Film Size		
	15 μ m	3 μ m	0.3 μ m
905 Stainless	75	20	30
906 Stainless	20	20	15
Zinc Diecast	10	5	4
906 Stainless Alloy	4	3	1*

*Until acceptable finish

- Clean the tool and connector face with a water rinse or lintless tissue dampened with alcohol. This prevents contamination of the finer film.
- Repeat Steps 4, 5, and 6 using the 3 micron film. Then repeat Steps 4, 5, and 6 using the 0.3 micron film.

Inspection

DANGER

Disconnect cable from power/signal source before inspecting.

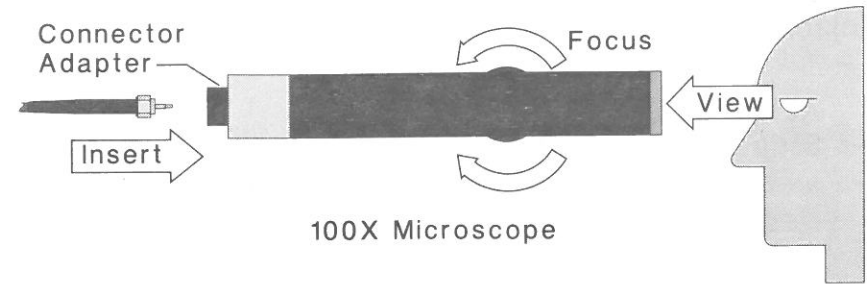

- Remove the connector from the polishing tool and clean its face with a lintless tissue dampened with alcohol or water.

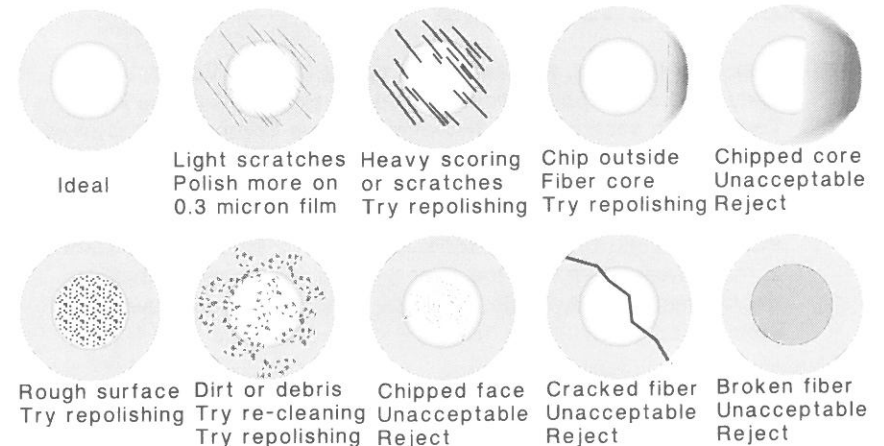

- Inspect the connector with a 100x microscope (AMP Part Nos. 504081-1, 504085-1, or equivalent) and if possible, place the far end of the fiber near a bright light. Compare the fiber end to the examples shown and take any recommended action.
- Also, check that the fiber is flush with the ferrule's surface by moving the microscope's focus control. If both the fiber and the ferrule's surface come into focus together, the fiber is flush. If their surfaces focus at different settings, additional polishing is required.

Unjacketed Fiber Notes

Unjacketed Fiber Preparation

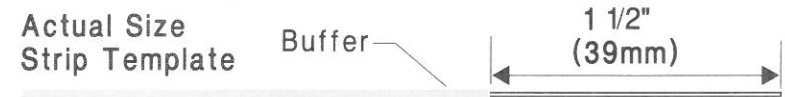

- 1 Strip 1 1/2 inches (38.1 mm) of the buffer from the fiber using a stripper tool (AMP Part No. 504024-2 or equivalent).
- 2 Wipe off the stripped fiber with a lintless tissue (AMP Part No. 504440-1 or equivalent) dampened with alcohol to remove debris.

Unjacketed Fiber Termination

- 1 Test feed the fiber, mix and inject epoxy into the Connector Body, and insert fiber following Steps 1 through 4 of the **Fiber Termination** section. Note however, that no Crimp Sleeve is used, therefore, Skip Steps 5 and 6.
- 2 Cure the epoxy following Step 7 of the **Fiber Termination** section except to place the connector sideways on a flat, heat-resistant surface. Make sure that the fiber remains fully inserted into the Connector Body while curing by holding the fiber down with tape placed a few inches from the connector. Skip Step 8.
- 3 Follow the Steps shown in the **Cleaving, Polishing, and Inspection** sections.