



Series		CCR-53	CCRT-53	CCS-32	CCRS-33
Configuration		SPDT	SPDT	SPDT	2P3T
Switch Function		Failsafe & Latching	Failsafe & Latching	Failsafe & Latching	Failsafe & Latching
Frequency		DC to 26.5 GHz	DC to 26.5 GHz	DC to 12 GHz	DC to 18 GHz
Coil Voltage		12, 15, 28	12, 15, 28	12, 15, 28	12, 15, 28
Connector		SMA	SMA	N, TNC	SMA
Temperature Range	Commercial Model	-25°C to +65°C	-25°C to +65°C	-25°C to +65°	-25°C to +65°
	Elite Model	-54°C to +85°C	-54°C to +85°C	-54°C to +85°	-54°C to +85°
Special Feature		High Frequency	50-Ohm Termination	High Power	Multipoint
Typical Contact Life		5,000,000 cycles	5,000,000 cycles	5,000,000 cycles	5,000,000 cycles
Typical RF Performance	VSWR (max)	DC-6 GHz to 1.25:1 6-12 GHz to 1.40:1 12-18 GHz to 1.50:1 18-26.5 GHz to 1.80:1 See Figure 16	DC-6 GHz to 1.25:1 6-12 GHz to 1.40:1 12-18 GHz to 1.50:1 18-26.5 GHz to 1.80:1 See Figure 16	DC-1 GHz to 1.25:1 1-4 GHz to 1.40:1 4-12 GHz to 1.70:1 See Figure 17	DC-6 GHz to 1.25:1 6-12 GHz to 1.40:1 12-18 GHz to 1.50:1 See Figure 15
	Insertion Loss (max)	DC-6 GHz to 0.20 dB 6-12 GHz to 0.40 dB 12-18 GHz to 0.50 dB 18-26.5 GHz to 0.70 dB See Figure 16	DC-6 GHz to 0.20 dB 6-12 GHz to 0.40 dB 12-18 GHz to 0.50 dB 18-26.5 GHz to 0.70 dB See Figure 16	DC-1 GHz to 0.30 dB 1-4 GHz to 0.40 dB 4-12 GHz to 0.50 dB See Figure 17	DC-6 GHz to 0.20 dB 6-12 GHz to 0.40 dB 12-18 GHz to 0.50 dB See Figure 15
	Isolation (min)	DC-6 GHz to 70.0 dB 6-12 GHz to 60.0 dB 12-18 GHz to 60.0 dB 18-26.5 GHz to 50.0 dB See Figure 16	DC-6 GHz to 70.0 dB 6-12 GHz to 60.0 dB 12-18 GHz to 60.0 dB 18-26.5 GHz to 50.0 dB See Figure 16	DC-1 GHz to 70.0 dB 1-4 GHz to 60.0 dB 4-12 GHz to 60.0 dB See Figure 17	DC-6 GHz to 70.0 dB 6-12 GHz to 60.0 dB 12-18 GHz to 60.0 dB See Figure 15
Options	Self Cutoff (Latching Only)	✓	✓	✓	✓
	Indicator Contacts	✓	✓	✓	✓
	Self Cutoff and Indicator Contacts (Latching Only)	✓	✓	✓	✓
	TTL Interface	✓	✓	✓	✓
	TTL Interface with Decoder				
	Moisture Seal	✓	✓	✓	✓
	Narrow Body	✓			
Typical Mechanical Outline		1.50 x 1.82 x .52 in. 38.1 x 46.2 x 13.2 mm See Figure 3	2.06 x 2.27 x .56 in. 52.3 x 57.7 x 14.2 mm See Figure 4	2.75 x 2.33 x .9 in. 69.9 x 59.2 x 22.9 mm See Figure 5	2.06 x 2.27 x .56 in. 52.3 x 57.7 x 14.2 mm See Figure 6
Shock		MIL-STD-202 Method 213, Condition D (500G Non Operating)	MIL-STD-202 Method 213, Condition D (500G Non Operating)	MIL-STD-202 Method 213, Condition D (500G Non Operating)	MIL-STD-202 Method 213, Condition D (500G Non Operating)
Vibration		MIL-STD-202 Method 214, Condition D (10G RMS Non Operating)	MIL-STD-202 Method 214, Condition D (10G RMS Non Operating)	MIL-STD-202 Method 214, Condition D (10G RMS Non Operating)	MIL-STD-202 Method 214, Condition D (10G RMS Non Operating)

Model Number

This guide shows the model numbers for Teledyne Relays switches. For technical support or custom switches for specific applications, call (800) 284-7007.

XXX-XX **X** **X** **X** **X - X** **X** **X - X**
 ① ② ③ ④ ⑤ ⑥ ⑦ ⑧ ⑨
 Multi-throw
 Only

Example: CCR-33S1O-T (Commercial SPDT, S=SMA, 28 Vdc, Failsafe, TTL)

①	Switch Model Series Type and Description						
	See tables on pages 1–5 for series name.						
②	Connector Type						
	<table style="width: 100%; border: none;"> <tr> <td style="width: 50%; border: none;">M Mini SMB</td> <td style="width: 50%; border: none;">S SMA Female</td> </tr> <tr> <td style="border: none;">N N Female</td> <td style="border: none;">T TCN Female</td> </tr> </table>	M Mini SMB	S SMA Female	N N Female	T TCN Female		
M Mini SMB	S SMA Female						
N N Female	T TCN Female						
③	Actuator Voltage						
	<table style="width: 100%; border: none;"> <tr> <td style="width: 50%; border: none;">1 28 Vdc – Failsafe (Normally Open if single-pole multi-throw)</td> <td style="width: 50%; border: none;">6 28 Vdc – Latching*</td> </tr> <tr> <td style="border: none;">2 15 Vdc – Failsafe (Normally Open if single-pole multi-throw)</td> <td style="border: none;">7 15 Vdc – Latching*</td> </tr> <tr> <td style="border: none;">3 12 Vdc – Failsafe (Normally Open if single-pole multi-throw)</td> <td style="border: none;">8 12 Vdc – Latching*</td> </tr> </table>	1 28 Vdc – Failsafe (Normally Open if single-pole multi-throw)	6 28 Vdc – Latching*	2 15 Vdc – Failsafe (Normally Open if single-pole multi-throw)	7 15 Vdc – Latching*	3 12 Vdc – Failsafe (Normally Open if single-pole multi-throw)	8 12 Vdc – Latching*
1 28 Vdc – Failsafe (Normally Open if single-pole multi-throw)	6 28 Vdc – Latching*						
2 15 Vdc – Failsafe (Normally Open if single-pole multi-throw)	7 15 Vdc – Latching*						
3 12 Vdc – Failsafe (Normally Open if single-pole multi-throw)	8 12 Vdc – Latching*						
④	Number Positions for Multi-throw						
	3–8 Indicates number of positions on multi-throw switches (skip this number if not single-pole multi-throw)						
⑤	Actuator Type						
	<table style="width: 100%; border: none;"> <tr> <td style="width: 50%; border: none;">O No cutoff or indicator contacts</td> <td style="width: 50%; border: none;">D Self cutoff only</td> </tr> <tr> <td style="border: none;">C Indicator contacts only</td> <td style="border: none;">E Self cutoff and indicator contacts</td> </tr> </table>	O No cutoff or indicator contacts	D Self cutoff only	C Indicator contacts only	E Self cutoff and indicator contacts		
O No cutoff or indicator contacts	D Self cutoff only						
C Indicator contacts only	E Self cutoff and indicator contacts						
⑥	TTL Driver*						
	<table style="width: 100%; border: none;"> <tr> <td style="width: 50%; border: none;">T TTL driver with diodes</td> <td style="width: 50%; border: none;">TD Decoders and TTL driver with diodes</td> </tr> </table>	T TTL driver with diodes	TD Decoders and TTL driver with diodes				
T TTL driver with diodes	TD Decoders and TTL driver with diodes						
⑦	Polarity						
	R Positive + Common						
⑧	Narrow Body						
	N SP2T switch only						
⑨	Custom Part Number						
	Assigned by Engineering						

* Polarity sensitive – contact factory

Note: Normally Open terminated switches are polarity sensitive

RF522

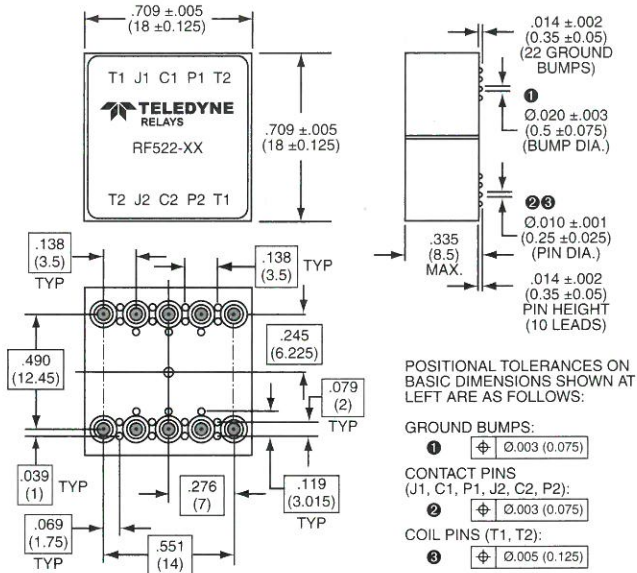

Figure 1

CCR-33, CCR-53

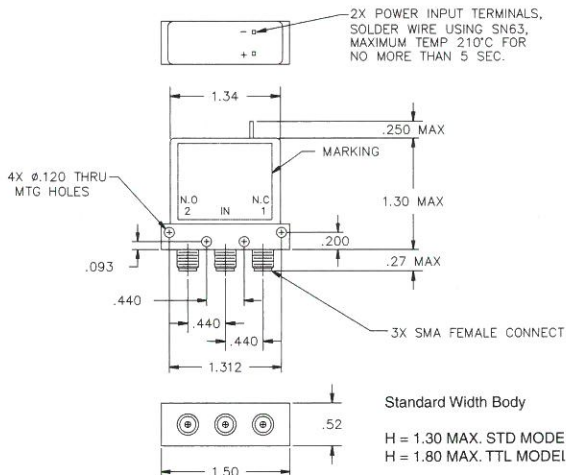
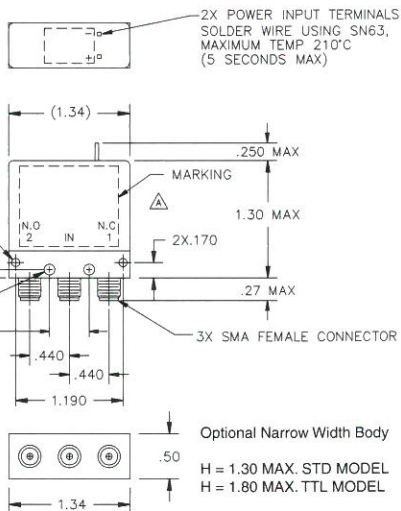

Figure 3



CCR-33M

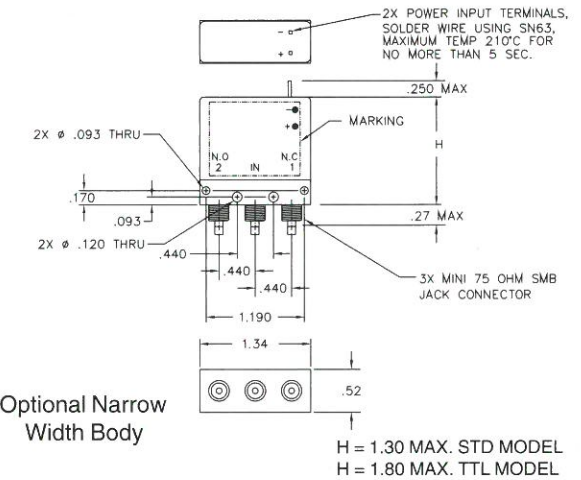
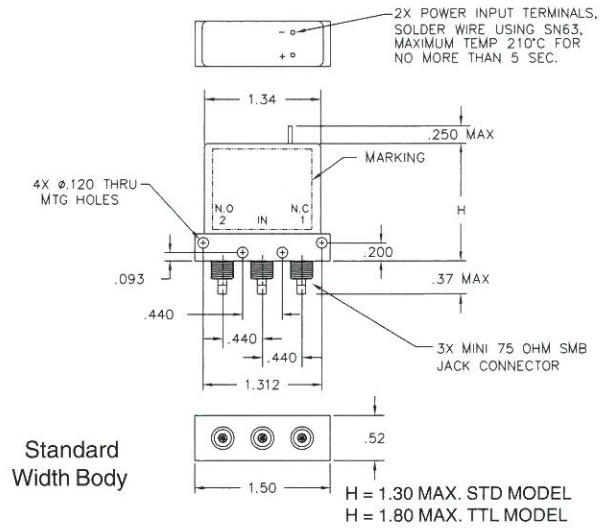

Figure 2

CCRT-33, CCRT-53

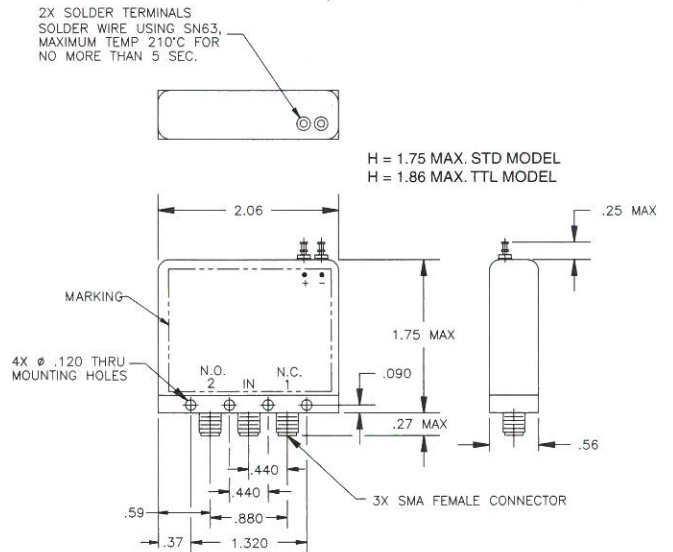

Figure 4

CCR-33M

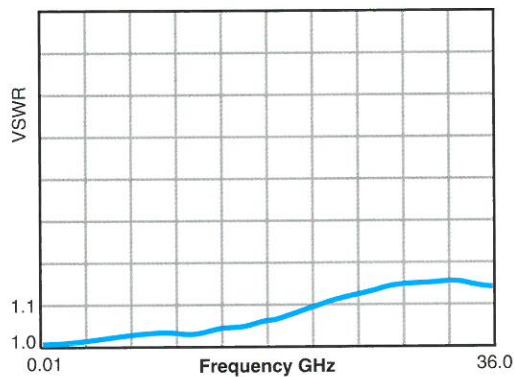
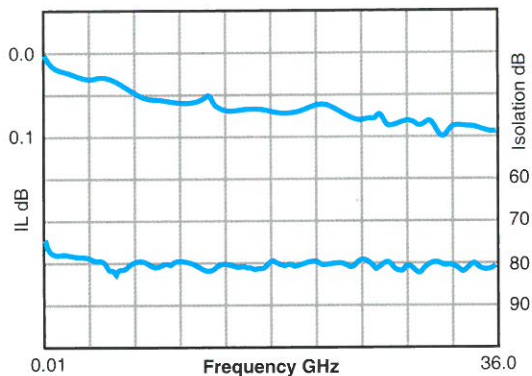

Figure 14

CCR-33, CCRT-33, CCRS-33

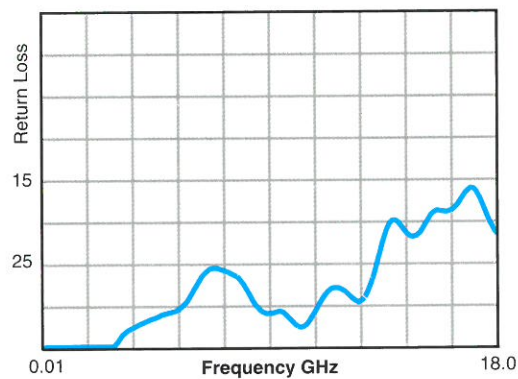
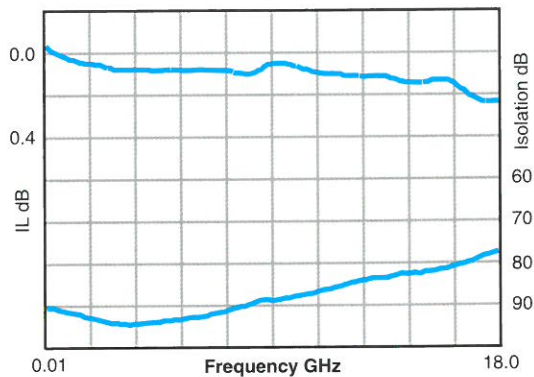

Figure 15

CCR-53, CCRT-53, CCRS-53

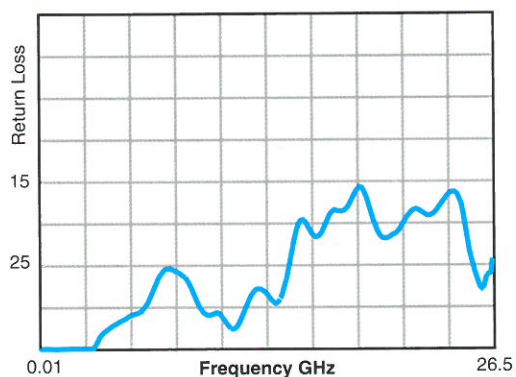
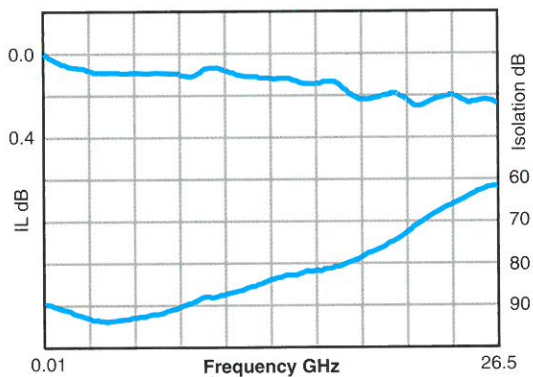

Figure 16

CCS-32, CCS-18

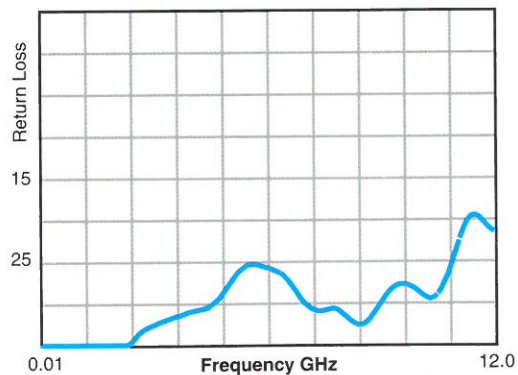
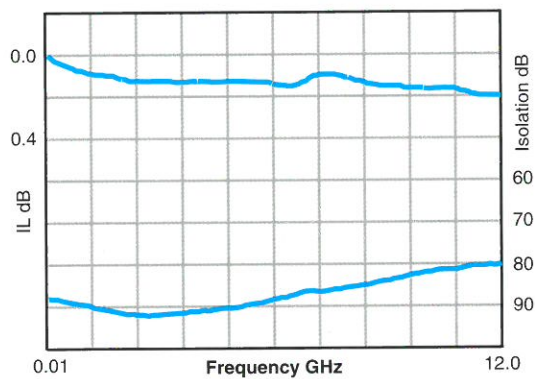

Figure 17