

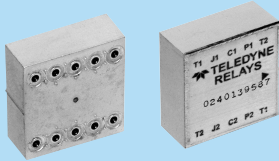

A Unit of Teledyne Electronics and Communications

HIGH-FREQUENCY, SURFACE-MOUNT, LATCHING RELAY DC UP TO 10 GHz

SERIES RF522



FEATURES AND BENEFITS

- Broadband width (DC to 10 GHz)
- Surface mount
- High isolation
- 50-ohm characteristic impedance
- Compact DPDT package
- Lead-free construction
- High RF power capability
- High repeatability

DETAILED ELECTRICAL SPECIFICATIONS

CONTACT SPECIFICATIONS (@25°C)			
Contact arrangement	DPDT (2 Form C)		
Contact load and life ratings	Load level DC Low level DC High level, resistive DC Overload, resistive	Contact load 10–50 μ A at 10–50 mVdc 0.5 A at 28 Vdc 1.0 A at 28 Vdc	Contact life 1,000,000 cycles, minimum 100,000 cycles, minimum 100 cycles, minimum
Contact resistance	0.150 Ω max. before life 0.300 Ω max. after low-level life		
Operate time	5.0 ms max (includes bounce time)		
RF power capabilities, carry only	30CW at 1 GHz 25CW at 3 GHz 20CW at 6 GHz Contact factory for higher frequencies		
Intercontact capacitance	0.03 pF (typical)		
Characteristic impedance	50 Ω		

COIL SPECIFICATIONS (@25°C)			
PART NUMBERS		RF522-5	RF522-12
Coil voltage, Vdc	Nom.	5	12
	Max.	6.0	14.4
Must operate voltage, Vdc		3.8	9.0
Coil resistance, ohms \pm 20%		25	144

ENVIRONMENTAL AND PHYSICAL SPECIFICATIONS		
Temperature (Ambient)	–55°C to +85°C	
Vibration (General Note 1)	Lesser of 0.06" double-amplitude or 10 g's, 10–2000 Hz	
Shock (General Note 1)	Direction of contact/drive motion	20 g's, 4 msec, half-sine
	Transverse directions	40 g's, 6 msec, half-sine
Enclosure	Hermetically sealed	
Surface Mounting	Reflowed soldered; 260°C max. reflow temperature	
Weight	0.49 oz. (14g) max.	

Insertion Loss

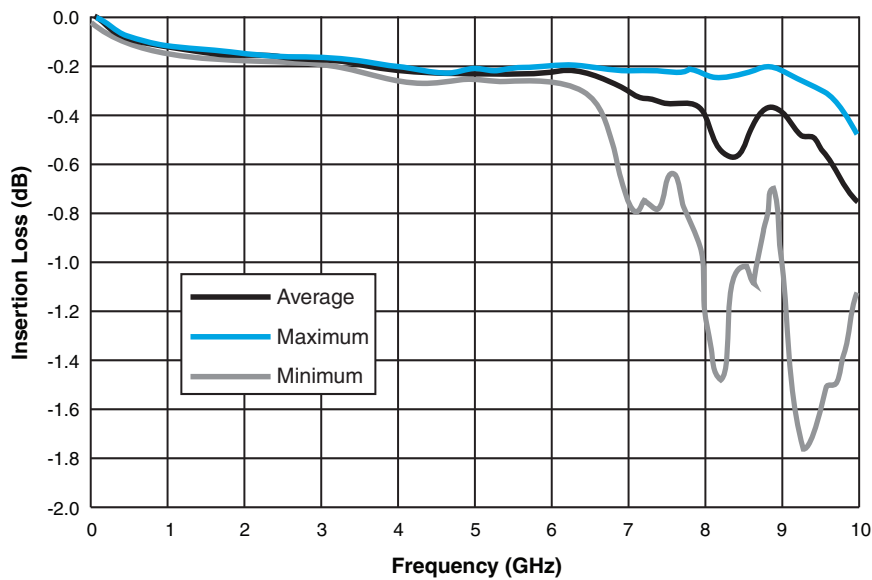

Average, minimum and maximum values from terminals P1 to C1 or P2 to C2 when the relay is in the Set position, or from terminals J1 to C1 or J2 to C2 when the relay is in the Reset position. The effect of the test board and connectors is de-embedded from the measurements. Data presented are typical performance characteristics of four representative relay samples surface-mounted onto a microstrip test board, with all grounding bumps soldered to the ground plane. Unused terminals are terminated with a 50 Ω load.

Across Contact Isolation

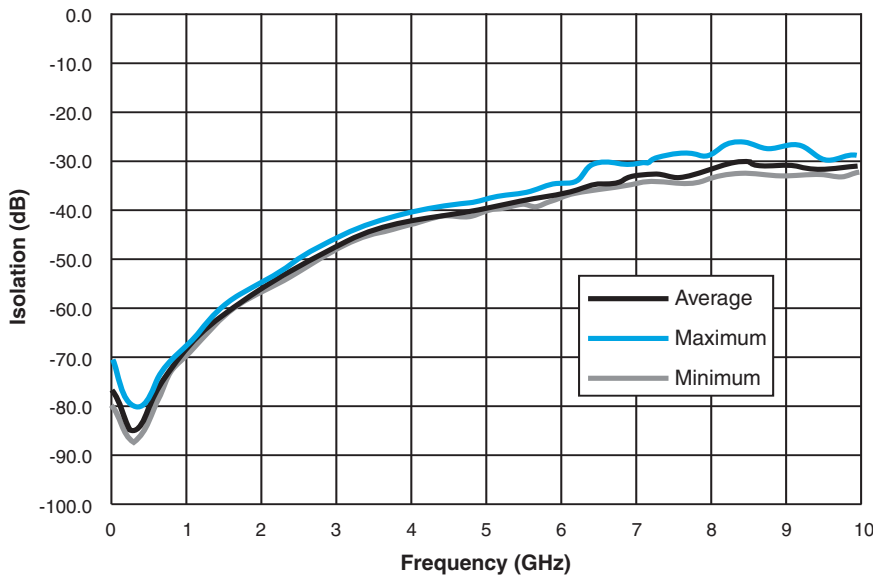

Average, minimum and maximum values from terminals P1 to J1 or P2 to J2. Data presented are typical performance characteristics of four representative relay samples surface-mounted onto a microstrip test board, with all grounding bumps soldered to the ground plane. Unused terminals are terminated with a 50 Ω load.

**SERIES RF522
TYPICAL RF CHARACTERISTICS**

Across Poles Isolation

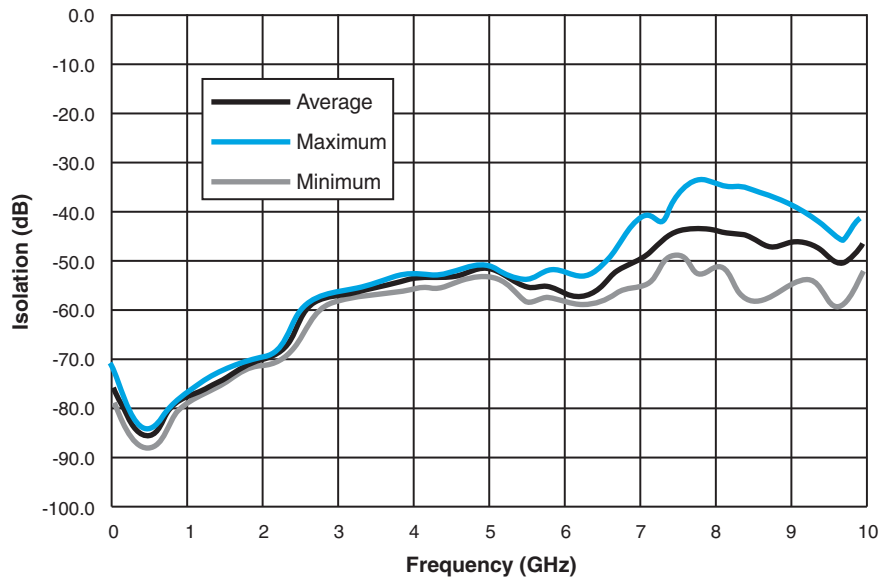

Average, minimum and maximum values from terminal C1 to C2. Data presented are typical performance characteristics of four representative relay samples surface-mounted onto a microstrip test board, with all grounding bumps soldered to the ground plane. Unused terminals are terminated with a 50 Ω load.

VSWR

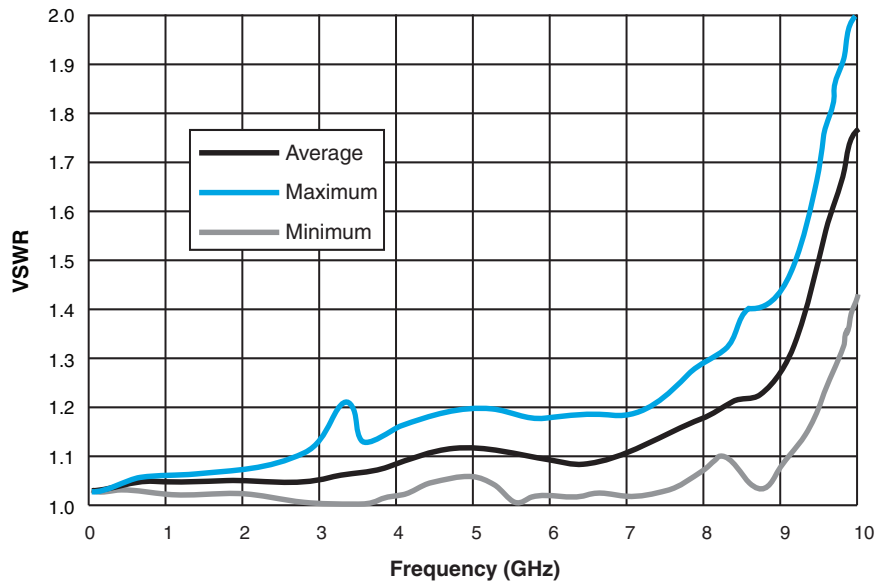

Average, minimum and maximum values from terminals P1 to C1 or P2 to C2 when the relay is in the Set position, or from terminals J1 to C1 or J2 to C2 when the relay is in the Reset position. Data presented are typical performance characteristics of four representative relay samples surface-mounted onto a microstrip test board, with all grounding bumps soldered to the ground plane. Unused terminals are terminated with a 50 Ω load.

**SERIES RF522
TYPICAL RF CHARACTERISTICS**

RF522 Insertion Loss Repeatability

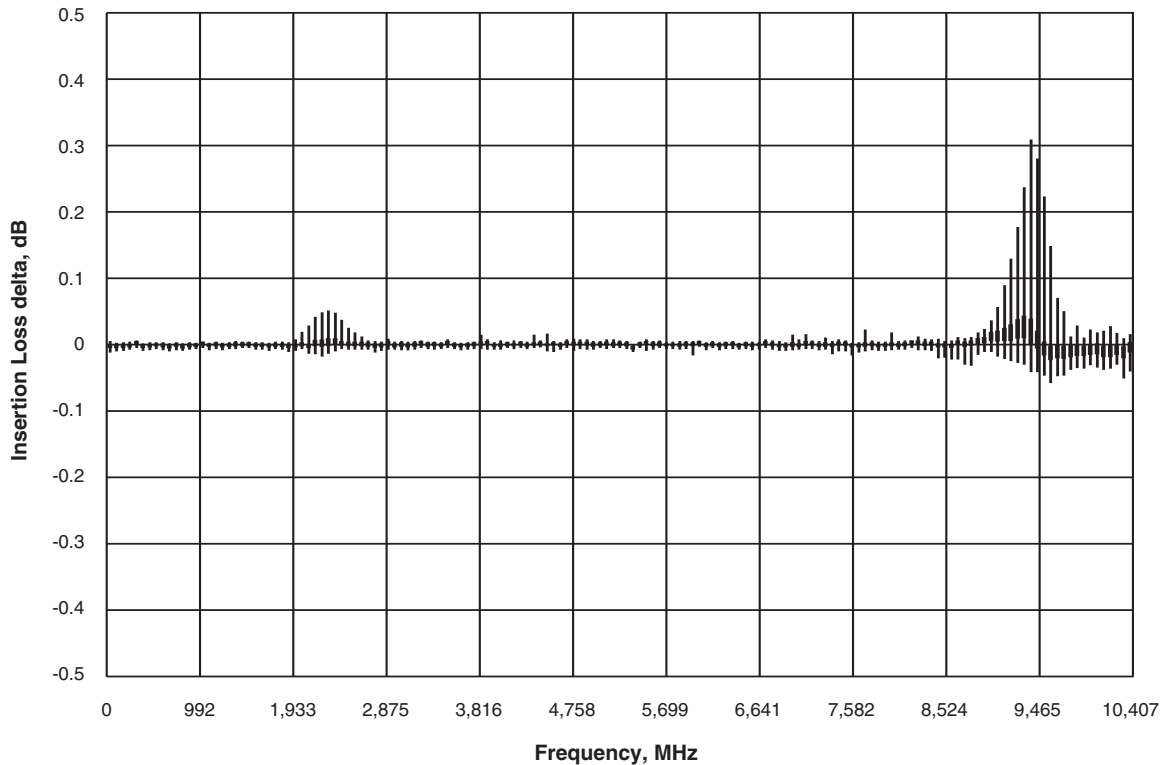

Differences between an initial measurement and 1000 subsequent measurements of a representative relay sample, from terminals P1 to C1 or P2 to C2 when relay is in the Set position, or from terminals J1 to C1 or J2 to C2 when relay is in the Reset position. Data presented are typical performance characteristics. Data taken from one sample RF522-12, mounted on PCB. Signal level is 0dBm, frequency range: 50MHz to 10.4 GHz. 201 data points per sweep.

TYPICAL TIME DOMAIN CHARACTERISTICS

Pulse Response

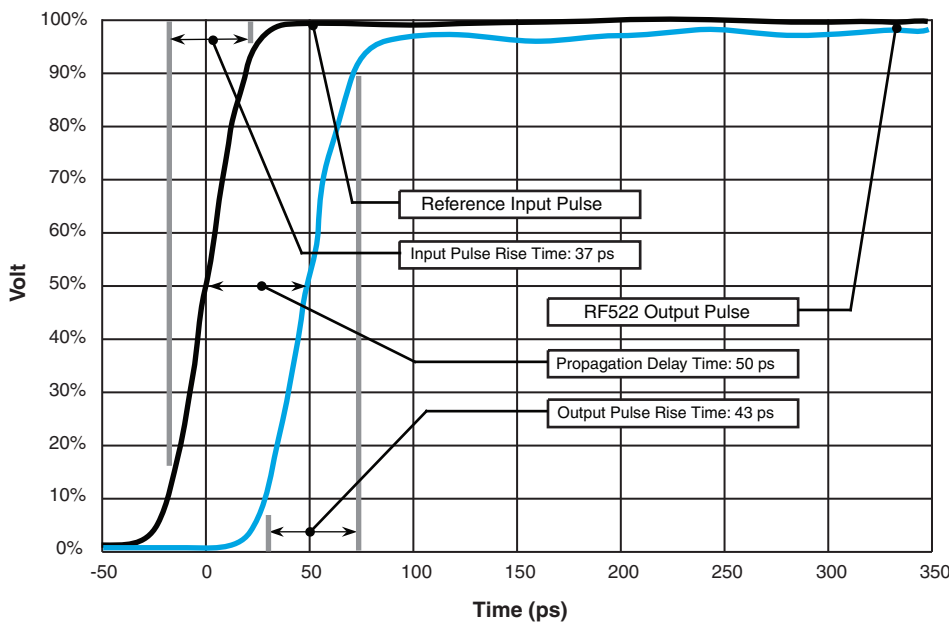

Data presented are typical performance characteristics of a representative relay sample measured using a coaxial test fixture, with all grounding bumps in contact with the ground plane. Unused terminals are terminated with a 50 Ω load. The effect of the test fixture is de-embedded from the measurements. Measurements are from terminals P1 to C1 or P2 to C2 when the relay is in the Set position, or from terminals J1 to C1 or J2 to C2 when the relay is in the Reset position.

**SERIES RF522
OUTLINE DIMENSIONS**

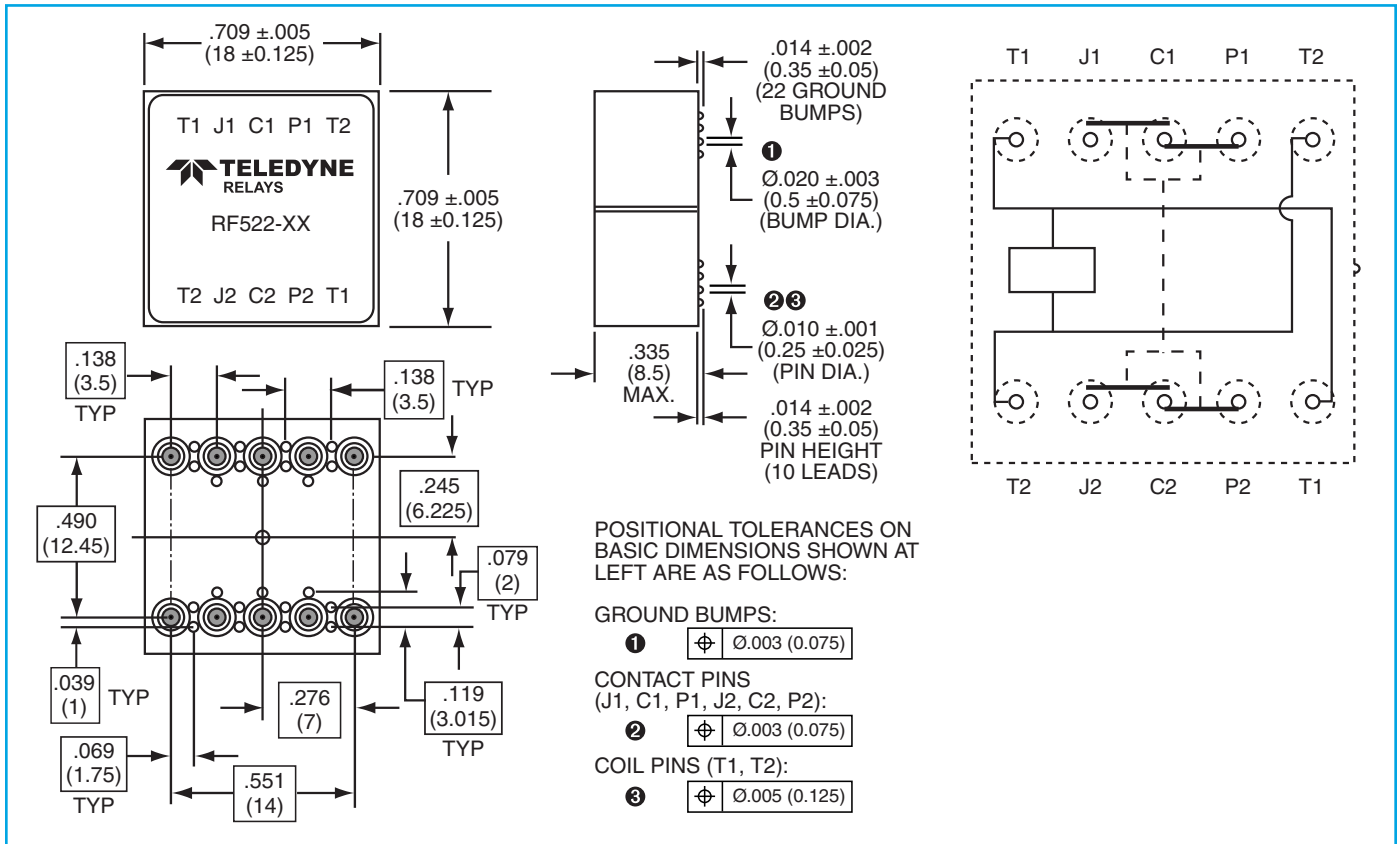

TRUTH TABLE						
Relay Position	Polarity Applied to Coil Terminal		Connection Status of Contact Terminal			
	T1	T2	P1	P2	J1	J2
Set	-	+	C1	C2	open	open
Reset	+	-	open	open	C1	C2

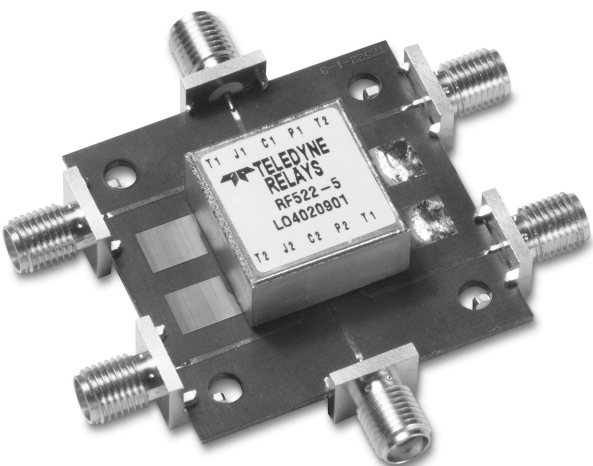
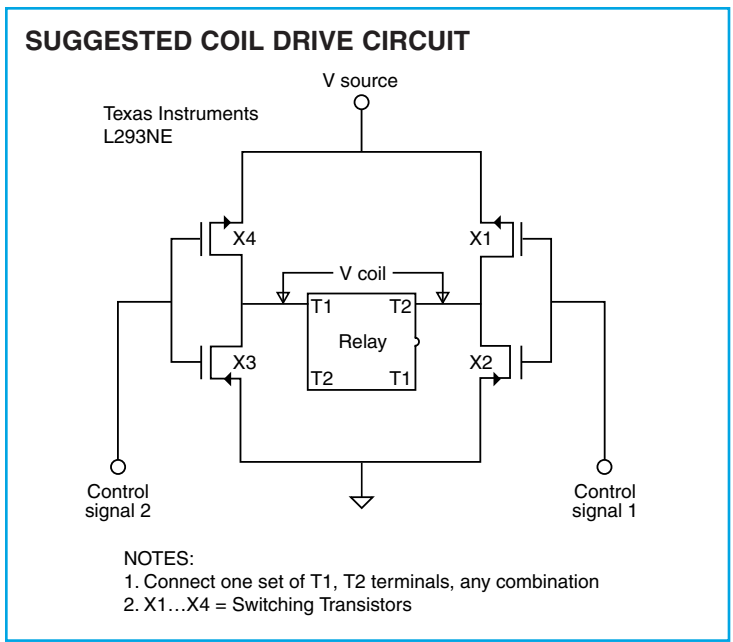

**Evaluation board available.
Order today. See Note 2.**

- GENERAL NOTES**
1. Relays will exhibit no contact chatter in excess of 10 μ sec or transfer in excess of 1 μ sec.
 2. To obtain a test kit (see right), call factory at (800) 284-7007 or (323) 777-0077 and order RF522-XX/K.
 3. For S parameters, visit www.teledyne.com or call applications engineer.
 4. For application notes, call applications engineer.

RF522 Performance vs. Other Relays

Insertion Loss

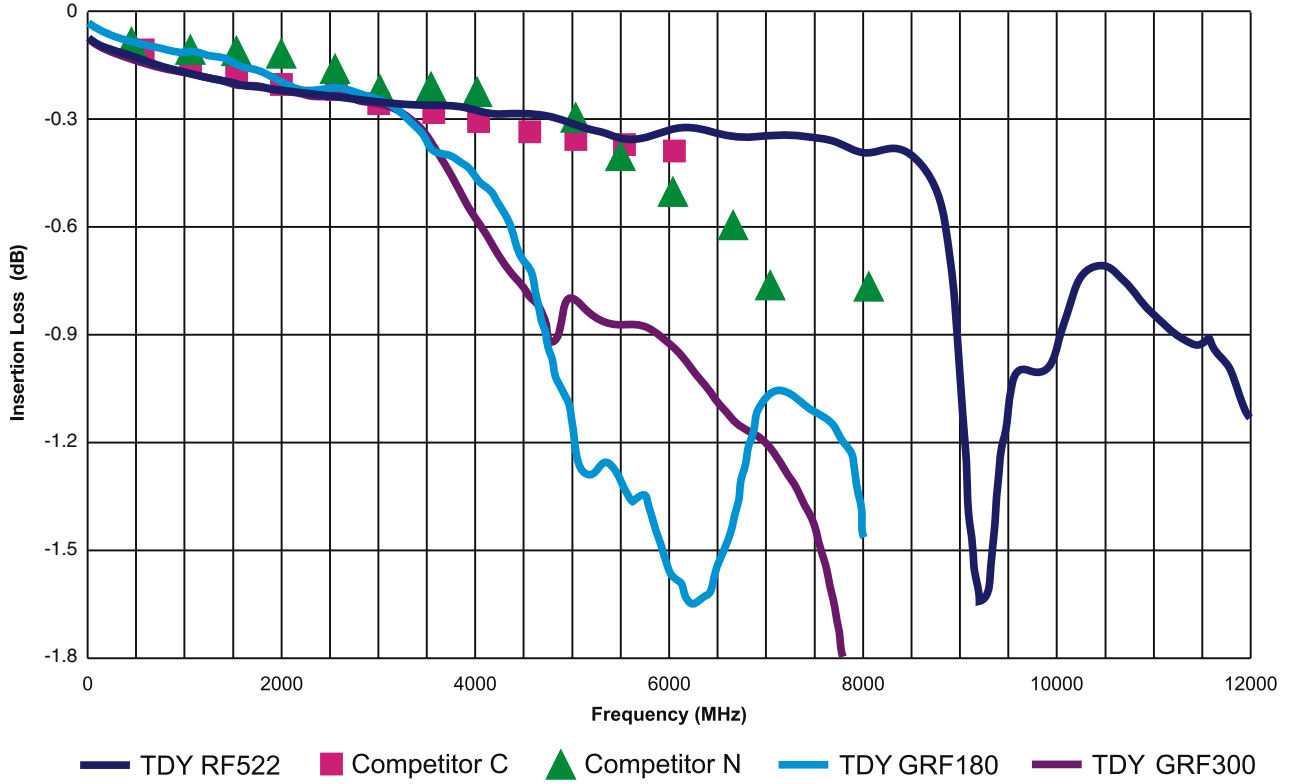

RF522 Performance vs. Other Relays

Isolation Pole to Pole

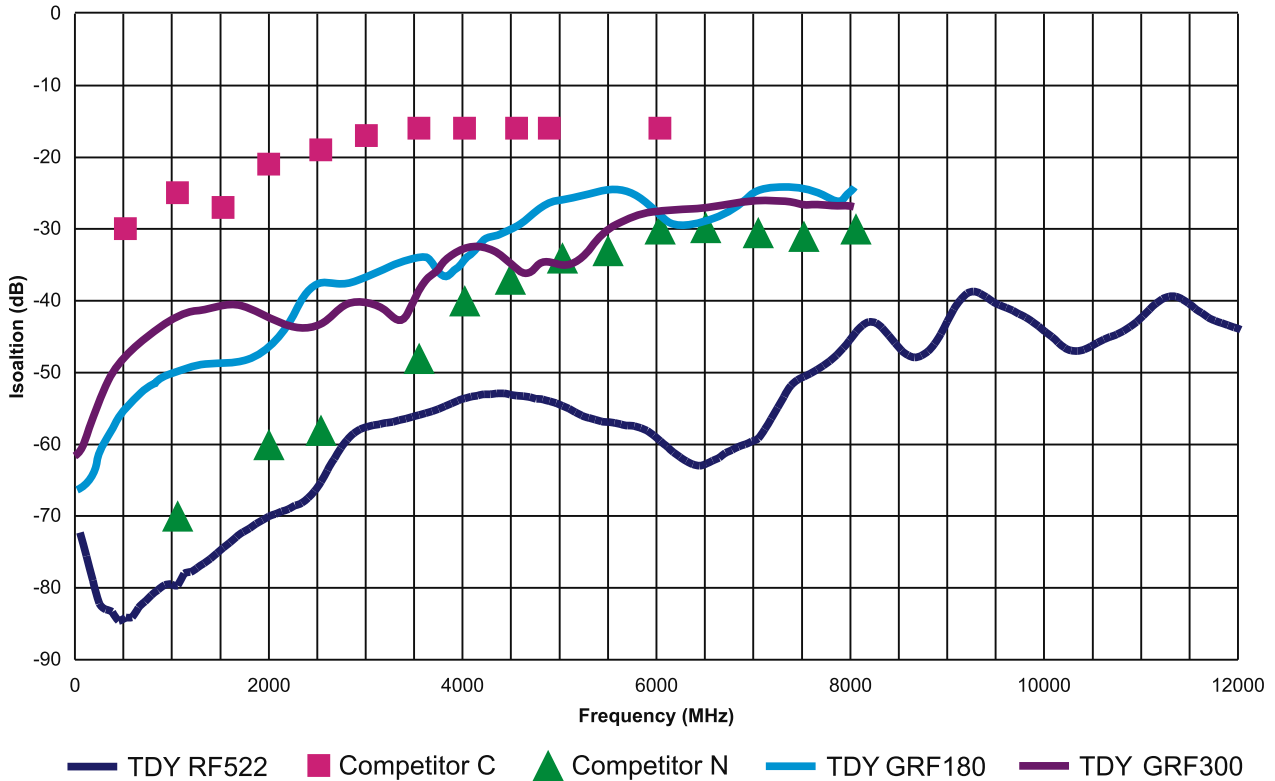

RF522 Smith Charts

Relay part number[s]: RF522-5, lot 040805-1B Number of samples: 1 Frequency range: .050 GHz to 6 GHz [1]
 Number of test points: 201 Number of sweeps over frequency range: 3 Test signal level: 0 dBm
 Data includes effect of test fixture: No Test apparatus: Vector Network Analyzer HP8719D
 Mounting: Relays surface mounted to RF PCB [Notes 2,5]
 Test temperature: Room ambient Test date: 09/22/04

NOTES: [1] S-parameters data swept from 0.050 GHz to 13.5 GHz
 [2] RF PCB: .0085" copper clad, reinforced PTFE, RT/duroid® 5880 with SMA connectors
 (RT/duroid® is registered trademark of Rogers Corporation)
 [3] During test, all untested ports are terminated with 50 W terminations
 [4] Data herein are typical values based on the sample tested. Not for use as specification requirements.
 [5] PCB copper backing 0.047" thick.

S-Parameter Measurements

Pole 1	Number Data Set	Pole 2	Number Data Set	Across Poles
1. Contact 1 Closed, port (IN,1)	1	1. Contact P2 Closed, pins (8,9)	1	9 N/A
2. Contact 1 Open, port (IN,1)	1	2. Contact P2 Open, pins (8,9)	1	10 N/A
3. Contact 2 Closed, port (IN,2)	1	3. Contact J2 Closed, pins (8,7)	1	
4. Contact 2 Open, port (IN,2)	1	4. Contact J2 Open, pins (8,7)	1	

Contact P1 designated a closed contact of pole 1 after pin T2 energized
 Contact J1 designated a closed contact of pole 1 after pin T1 energized

RF522-5, Lot 040805-1B, P1 Closed

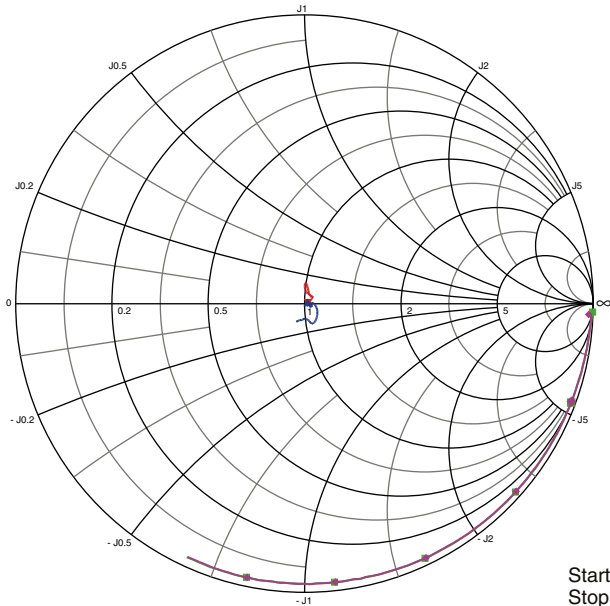

RF522-5, Lot 040805-1B, P1 Isolation

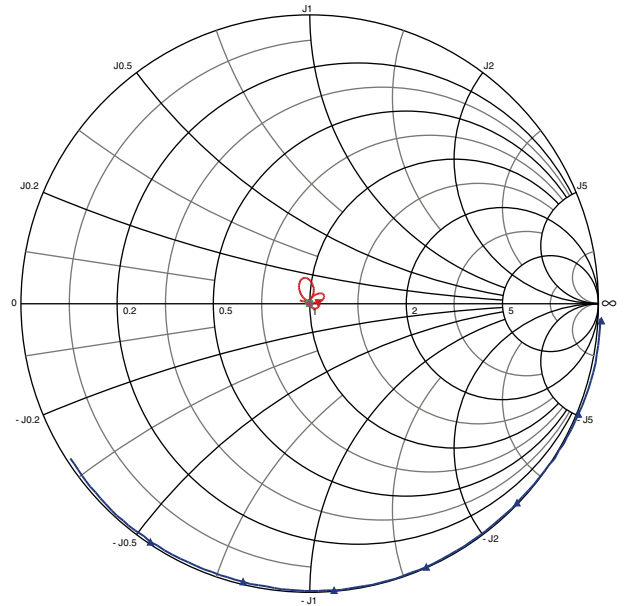

RF522-5, Lot 040805-1B, J1 Closed

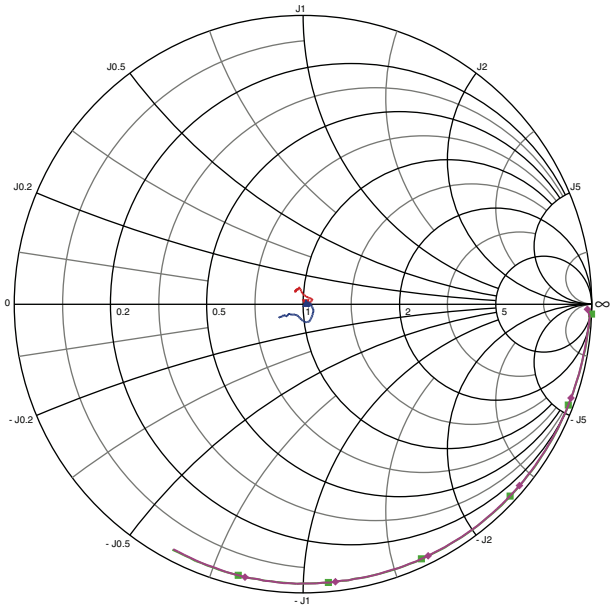

RF522-5, Lot 040805-1B, J1 Isolation

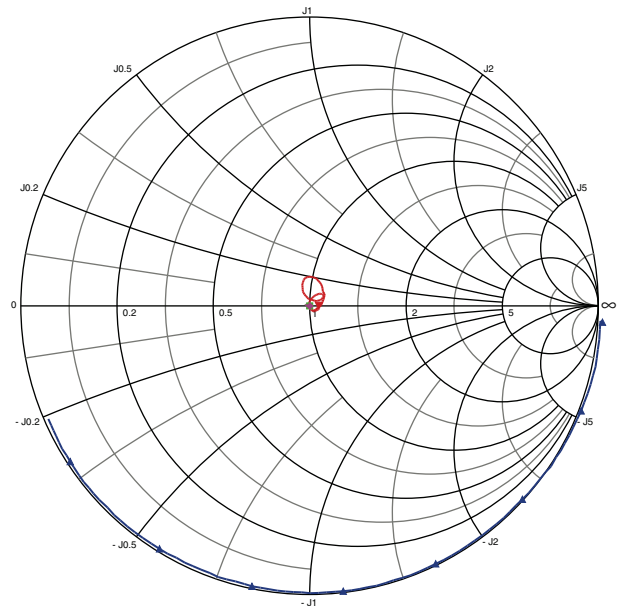

RF522 Smith Charts

RF522-5, Lot 040805-1B, P2 Closed

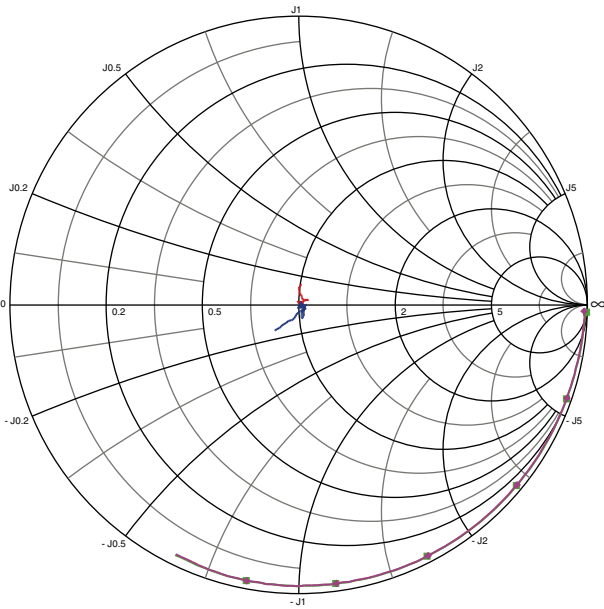

RF522-5, Lot 040805-1B, P2 Isolation

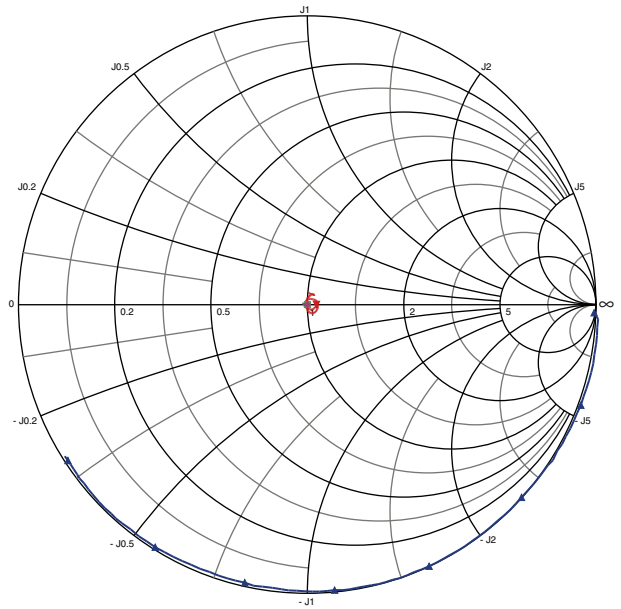

Start 0.5GHz
Stop 6.0GHz
■ S11 ■ S21 ◆ S12 ▲ S22

RF522-5, Lot 040805-1B, J2 Closed

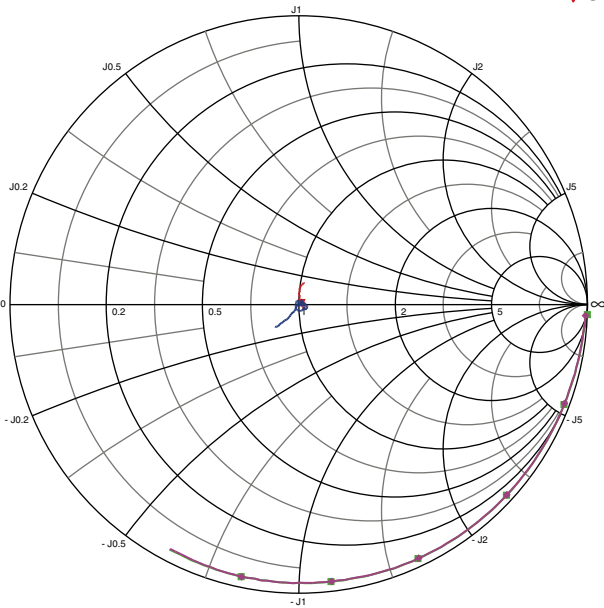

RF522-5, Lot 040805-1B, J2 Isolation

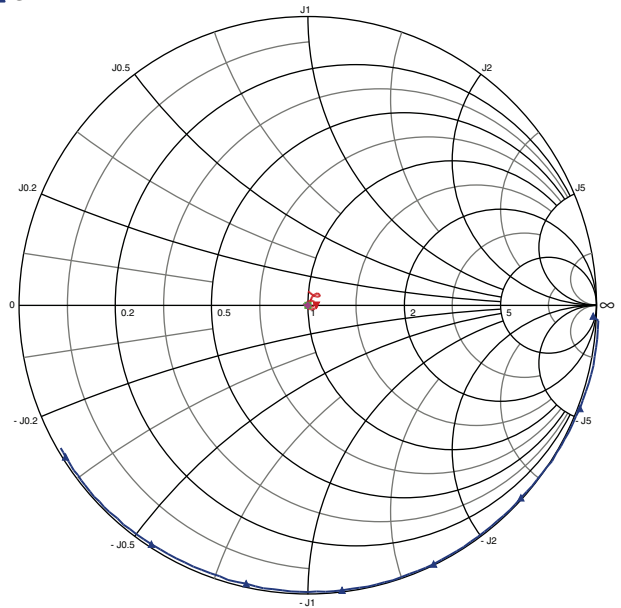

Surfacing Mounting RF522 Relay on to a PCB

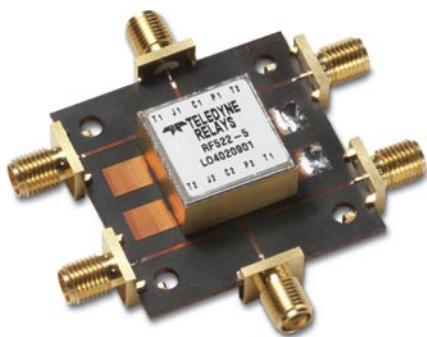

This application note provides a detailed description of how Teledyne mounts RF522 onto evaluation test boards. The surface mounting information, printed circuit board (PCB) artwork for circuit traces, and RF ground plane configurations are used for mounting a single relay on a single evaluation board.

The information provided herein may be used for reference in design and mounting of RF522.

- This page and the next give the following information for laying out the printed circuit board (dimensions shown are in inches):

- RF522 Outline Dimensions
- PCB Layout: Circuit Side & Ground Plane Side
- RF522 Stencil Layout and Aperture Size
- RF522 Rework/Removal Recommendations

- Printed Circuit Board
 - a. Material: RT/duroid®5880 (registered trademark of Rogers Corporation)
 - b. Dielectric thickness: 0.0083"
 - c. Copper foil thickness: 1/2 oz. ED
 - d. Copper backing (ground plane): 0.040"
 - e. All hole dimensions are after plate

- Solder stencil thickness: 0.008"

- Trace configurations, board material, outline, size, etc. may require changes per user's application requirements.

- RF522 relays may be subjected to solder reflow peak temperatures of 260°C maximum, for 1 minute, 3 passes.

- Check with solder supplier for recommended solder reflow temperature profile for selected solder paste and specific application requirements.

- Ground bumps must be soldered to RF ground plane.

RF522 Outline Dimensions

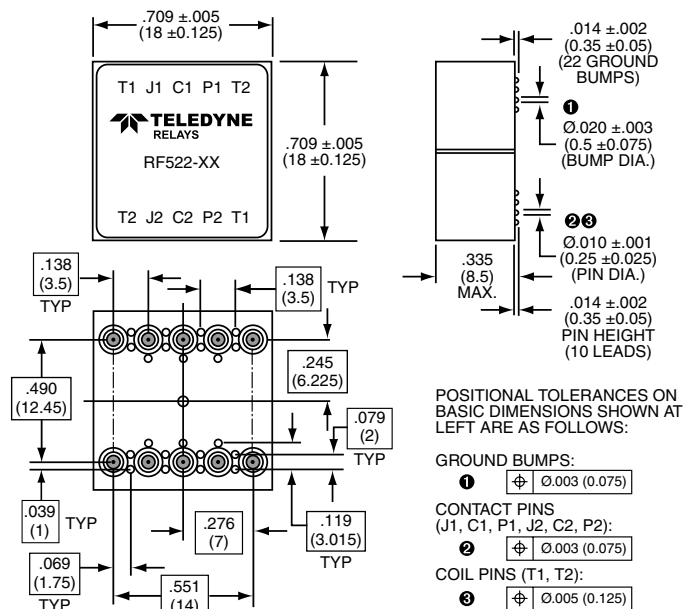

RF522 PCB Layout

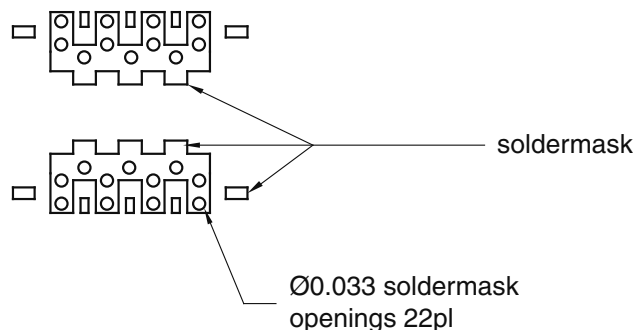
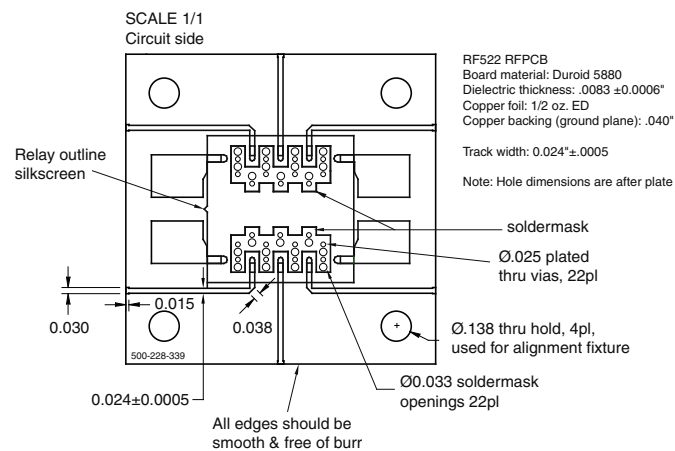

RF522 PCB Layout (continued)

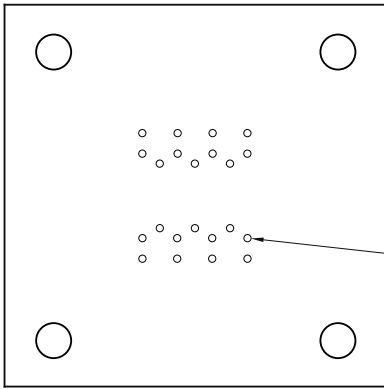

RF522 RFPCB
 Board material: Duroid 5880
 Dielectric thickness: .0083 ±0.0006"
 Copper foil: 1/2 oz. ED
 Copper backing (ground plane): .040"

Track width: 0.024"±.0005

Note: Hole dimensions are after plate

Ø.025 plated thru vias, 22pl

Ground plane side

RF522 Stencil Layout and Aperture

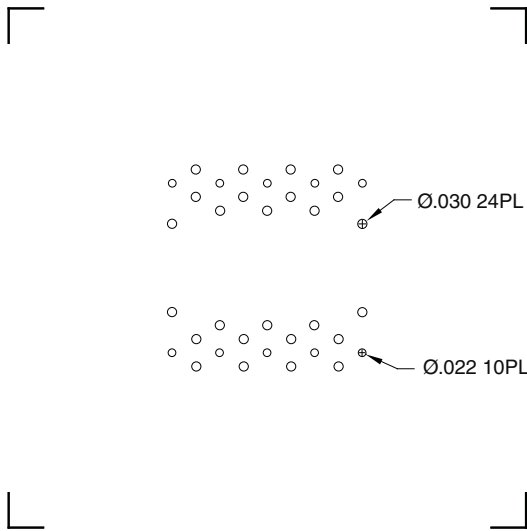

RF522 Rework/Removal Recommendations

Reworking the RF522 is similar to reworking BGA components. As with BGA, the leads/solder joints are underneath the unit. This makes it nearly impossible to remove the relay with a soldering iron. Fortunately there are tools/solutions available for reworking/removing the RF522 relay. The first step begins in the layout design.

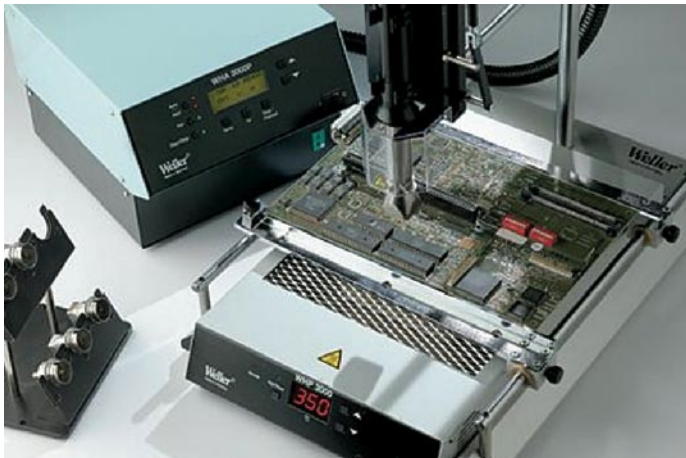

If board rework is envisioned in the future, component spacing should be taken into consideration to allow for future rework tools to be used. Allowing enough spacing for a hot air nozzle is recommended.

It's highly recommended to preheat the board prior to applying full heat. Preheating the board facilitates the rework process by avoiding large temperature differentials and potential board warpage. Preheating will also reduce the possibility of thermal shock to the board and assembly. Preheat temperature may range anywhere from 90 to 130°C.

Hand-held as well as automatic hot gas rework systems are the logical removal tool to use. The "Hot Air" is forced throughout the RF522 reflowing the hard to reach solder joints. The Hot Air should be directed underneath the relay. Nozzles with vacuum suction are highly recommended. Most automatic stations included the vacuum suction feature. Vacuum tweezers are also available.

Equipment manufactures include:

Hakkoo
 Weller
 Xytronic
 Zephytronics
 And many more.

