

HiPerFAST™ IGBT Lightspeed™ Series

**IXGH 32N60C
IXGT 32N60C**

V_{CES} = 600 V
I_{C25} = 60 A
V_{CE(sat)typ} = 2.1 V
t_{fi typ} = 55 ns

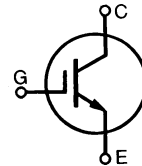

Symbol	Test Conditions	Maximum Ratings	
V _{CES}	T _J = 25°C to 150°C	600	V
V _{CGR}	T _J = 25°C to 150°C; R _{GE} = 1 MΩ	600	V
V _{GES}	Continuous	±20	V
V _{GEM}	Transient	±30	V
I _{C25}	T _C = 25°C	60	A
I _{C110}	T _C = 110°C	32	A
I _{CM}	T _C = 25°C, 1 ms	120	A
SSOA (RBSOA)	V _{GE} = 15 V, T _{VJ} = 125°C, R _G = 10 Ω Clamped inductive load, L = 100 μH	I _{CM} = 64 @ 0.8 V _{CES}	A
P _C	T _C = 25°C	200	W
T _J		-55 ... +150	°C
T _{JM}		150	°C
T _{stg}		-55 ... +150	°C
Maximum lead temperature for soldering 1.6 mm (0.062 in.) from case for 10 s		300	°C
M _d	Mounting torque (M3)	1.13/10 Nm/lb.in.	
Weight		TO-247 AD	6 g
		TO-268	4 g

**TO-268
(IXGT)**

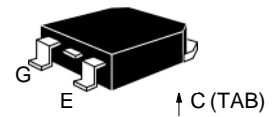

**TO-247 AD
(IXGH)**

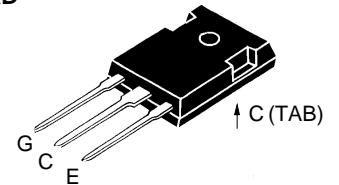

G = Gate, C = Collector,
E = Emitter, TAB = Collector

Features

- International standard packages JEDEC TO-247 and surface mountable TO-268
- High current handling capability
- Latest generation HDMOS™ process
- MOS Gate turn-on - drive simplicity

Applications

- PFC circuits
- Uninterruptible power supplies (UPS)
- Switched-mode and resonant-mode power supplies
- AC motor speed control
- DC servo and robot drives
- DC choppers

Advantages

- High power density
- Very fast switching speeds for high frequency applications

Symbol	Test Conditions	Characteristic Values (T _J = 25°C, unless otherwise specified)		
		min.	typ.	max.
BV_{CES}	I _C = 250 μA, V _{GE} = 0 V	600		V
V_{GE(th)}	I _C = 250 μA, V _{CE} = V _{GE}	2.5		5 V
I_{CES}	V _{CE} = 0.8 • V _{CES} V _{GE} = 0 V			T _J = 25°C: 200 μA T _J = 150°C: 1 mA
I_{GES}	V _{CE} = 0 V, V _{GE} = ±20 V			±100 nA
V_{CE(sat)}	I _C = I _{C110} , V _{GE} = 15 V		2.1	2.5 V

Symbol	Test Conditions	Characteristic Values ($T_J = 25^\circ\text{C}$, unless otherwise specified)		
		min.	typ.	max.
g_{fs}	$I_C = I_{C110}, V_{CE} = 10\text{ V}$, Pulse test, $t \leq 300\ \mu\text{s}$, duty cycle $\leq 2\%$		25	S
C_{ies}	$V_{CE} = 25\text{ V}, V_{GE} = 0\text{ V}, f = 1\text{ MHz}$		2700	pF
C_{oes}			190	pF
C_{res}			50	pF
Q_g	$I_C = I_{C110}, V_{GE} = 15\text{ V}, V_{CE} = 0.5 V_{CES}$		110	nC
Q_{ge}			22	nC
Q_{gc}			40	nC
$t_{d(on)}$	Inductive load, $T_J = 25^\circ\text{C}$ $I_C = I_{C110}, V_{GE} = 15\text{ V}, L = 100\ \mu\text{H}$, $V_{CE} = 0.8 V_{CES}, R_G = R_{off} = 4.7\ \Omega$ Remarks: Switching times may increase for V_{CE} (Clamp) $> 0.8 \cdot V_{CES}$, higher T_J or increased R_G		25	ns
t_{ri}			20	ns
$t_{d(off)}$			85	ns
t_{fi}			55	ns
E_{off}			0.32	mJ
$t_{d(on)}$	Inductive load, $T_J = 150^\circ\text{C}$ $I_C = I_{C110}, V_{GE} = 15\text{ V}, L = 100\ \mu\text{H}$, $V_{CE} = 0.8 V_{CES}, R_G = R_{off} = 4.7\ \Omega$ Remarks: Switching times may increase for V_{CE} (Clamp) $> 0.8 \cdot V_{CES}$, higher T_J or increased R_G		25	ns
t_{ri}			25	ns
E_{on}			0.30	mJ
$t_{d(off)}$			110	170 ns
t_{fi}			105	160 ns
E_{off}			0.85	1.25 mJ
R_{thJC}			0.62	K/W
R_{thCK}	(IXGH32N60C)		0.25	K/W

TO-247 AD (IXGH) Outline



Dim.	Millimeter		Inches	
	Min.	Max.	Min.	Max.
A	19.81	20.32	0.780	0.800
B	20.80	21.46	0.819	0.845
C	15.75	16.26	0.610	0.640
D	3.55	3.65	0.140	0.144
E	4.32	5.49	0.170	0.216
F	5.4	6.2	0.212	0.244
G	1.65	2.13	0.065	0.084
H	-	4.5	-	0.177
J	1.0	1.4	0.040	0.055
K	10.8	11.0	0.426	0.433
L	4.7	5.3	0.185	0.209
M	0.4	0.8	0.016	0.031
N	1.5	2.49	0.087	0.102

TO-268AA (D³ PAK)

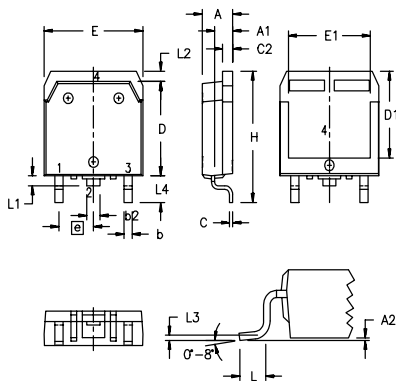

Dim.	Millimeter		Inches	
	Min.	Max.	Min.	Max.
A	4.9	5.1	.193	.201
A ₁	2.7	2.9	.106	.114
A ₂	.02	.25	.001	.010
b	1.15	1.45	.045	.057
b ₂	1.9	2.1	.75	.83
C	.4	.65	.016	.026
D	13.80	14.00	.543	.551
E	15.85	16.05	.624	.632
E ₁	13.3	13.6	.524	.535
e	5.45 BSC		.215 BSC	
H	18.70	19.10	.736	.752
L	2.40	2.70	.094	.106
L1	1.20	1.40	.047	.055
L2	1.00	1.15	.039	.045
L3	0.25 BSC		.010 BSC	
L4	3.80	4.10	.150	.161

Min. Recommended Footprint

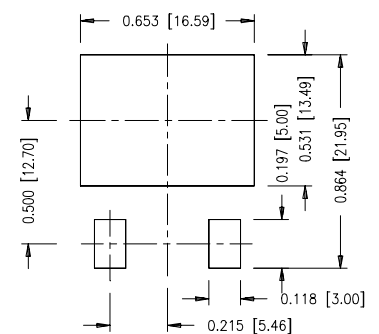

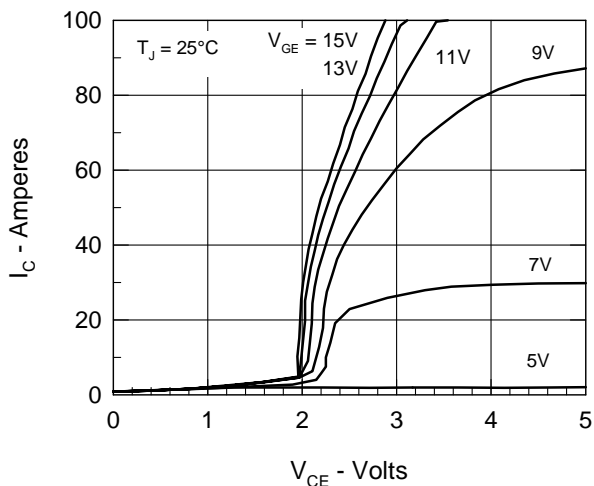

Fig. 1. Output Characteristics

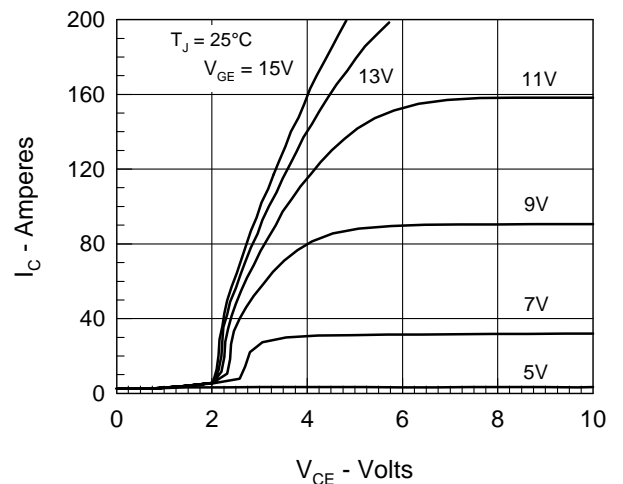

Fig. 2. Extended Output Characteristics

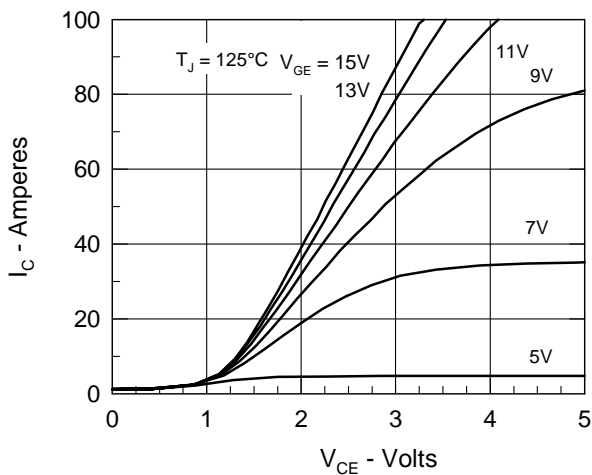

Fig. 3. High Temperature Output Characteristics

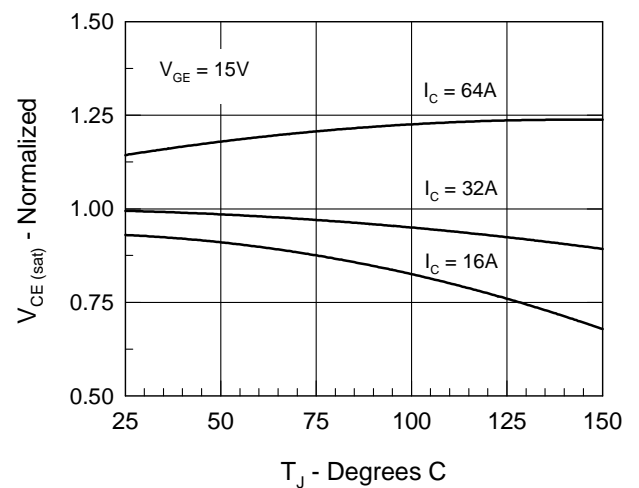
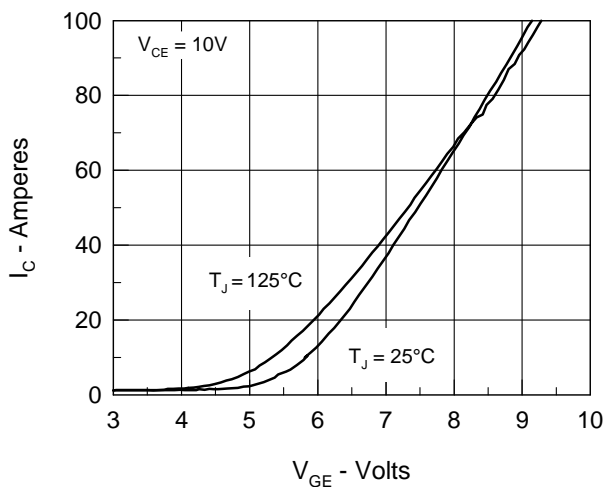

 Fig. 4. Temperature Dependence of $V_{CE(sat)}$

Fig. 5. Admittance Curves

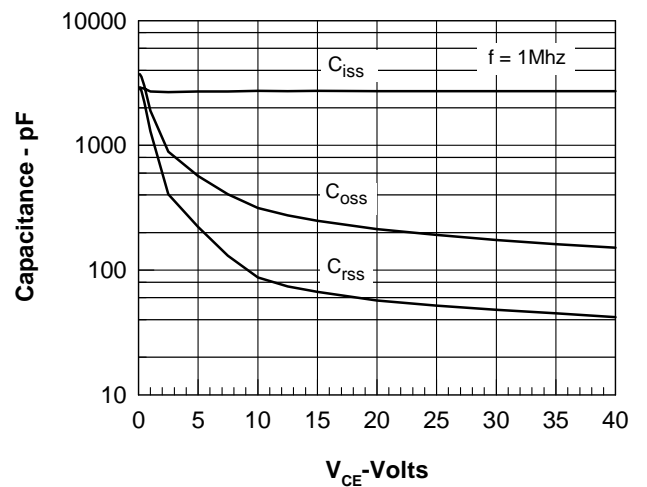

Fig. 6. Capacitance Curves

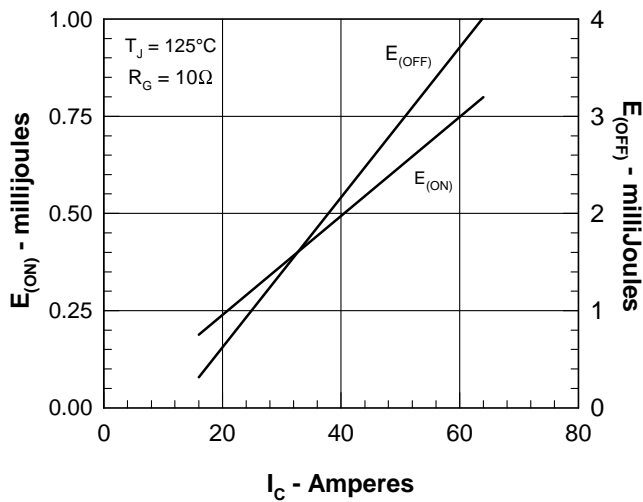

Fig. 7. Dependence of E_{ON} and E_{OFF} on I_C .

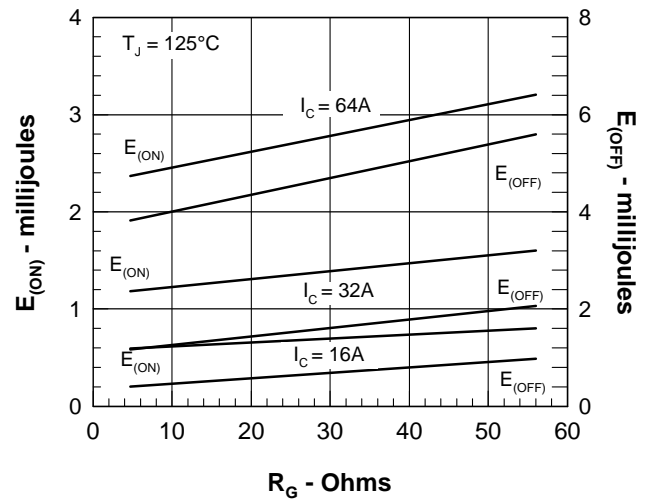

Fig. 8. Dependence of E_{ON} and E_{OFF} on R_G .

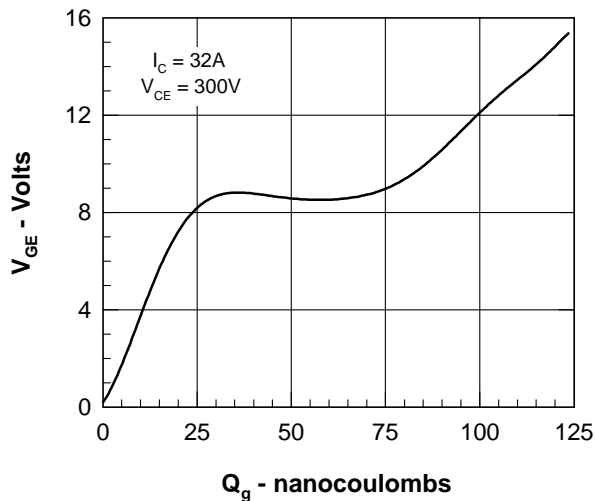

Fig. 9. Gate Charge

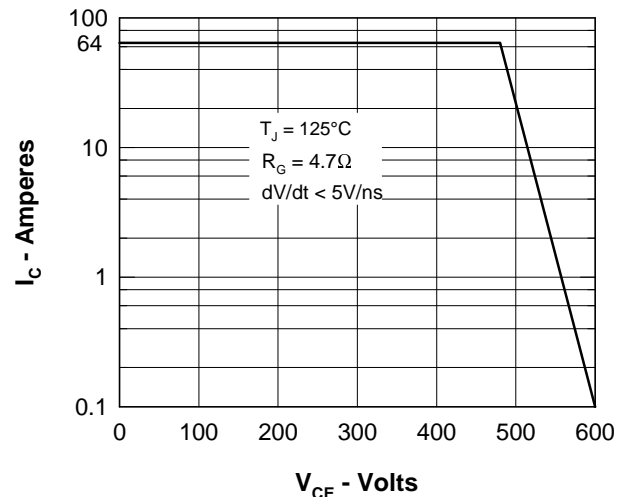

Fig. 10. Turn-off Safe Operating Area

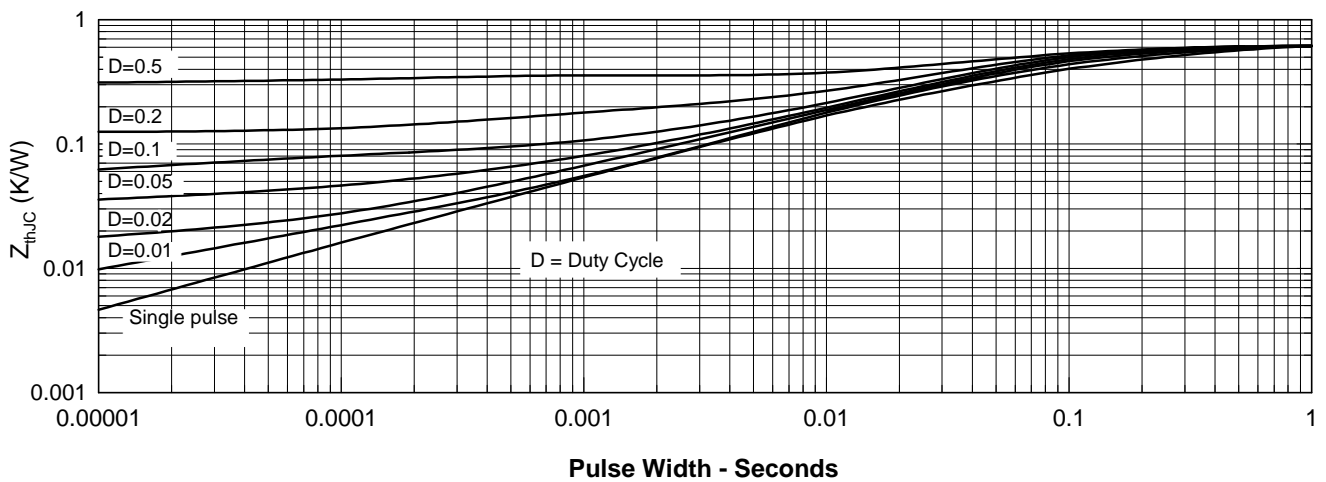

Fig. 11. Transient Thermal Resistance