

Silicon RECTIFIER

A540

2400 Volts 1000 Amps Avg.

The A540 Series of high power rectifier diodes feature the newly developed, multi-diffusion technology in a new General Electric pressure-mounted package.

FEATURES:

- High Current, High Voltage
- Pressure Contacts
- Glazed Ceramic Package with 1" Creepage Path
- Reversibility (eliminates need for special reverse polarity units)
- Hermetic Seal
- Available in Factory Assembled Heat Exchangers or Ready-to-Mount

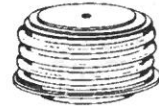

IMPORTANT: Mounting instructions on the last page of the C501 specification must be followed.

MAXIMUM ALLOWABLE RATINGS

TYPE	REPETITIVE PEAK REVERSE VOLTAGE, V_{RRM} $T_J = -40^{\circ}\text{C to } +185^{\circ}\text{C}$	NON-REPETITIVE REVERSE VOLTAGE, V_{RSM} $T_J = 0^{\circ}\text{C to } +185^{\circ}\text{C}$	V_{RRM}/V_{RSM} $T_J = 185^{\circ}\text{C to } 200^{\circ}\text{C}$
• A540LD	• 2400 Volts	• 2500 Volts	• 2000 Volts
A540LC	2300	2400	1950
A540LB	2200	2300	1850
A540LA	2100	2200	1750
A540L	2000	2100	1700

Lower voltages available – consult factory.

Average Forward Current	1000 Amperes, 1 Φ Average
Peak One-Cycle Surge Current	12,000 Amperes
Minimum I ² t Rating (for times \geq 1.5 msec)	285,000 Ampere ² Seconds
Minimum I ² t Rating (at 8.3 msec)	597,000 Ampere ² Seconds
Maximum Forward Voltage Drop ($T_C = 160^{\circ}\text{C}$ Case Temperature, 1000 Amps. Peak)	1.08 Volts
Peak Reverse Leakage Current ($T_J = 200^{\circ}\text{C}$, $V = \text{Rated } V_{RRM}$)	35mA
Maximum Thermal Resistance, $R_{\theta JS}$ (Double-Side Cooling)	0.06 $^{\circ}\text{C/Watt}$
Storage Temperature, T_{STG}	-40 $^{\circ}\text{C}$ to +200 $^{\circ}\text{C}$
Operating Junction Temperature, T_J	-40 $^{\circ}\text{C}$ to +200 $^{\circ}\text{C}$
Mounting Force Required	2200 Lbs. \pm 10% 9.8 KN \pm 10%

NOTES:

¹ Assumes a heatsink thermal resistance of less than 1.1 $^{\circ}\text{C/watt}$.

² Non-recurrent voltage and current ratings, as contrasted to repetitive ratings which apply for occasional or unpredictable overloads. For example, the forward surge current ratings are non-recurrent ratings that are used in fault coordination work.

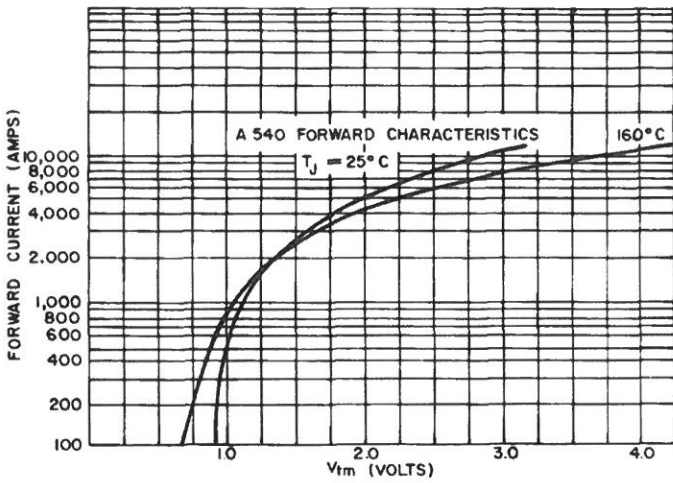

1. MAXIMUM ON-STATE CHARACTERISTICS

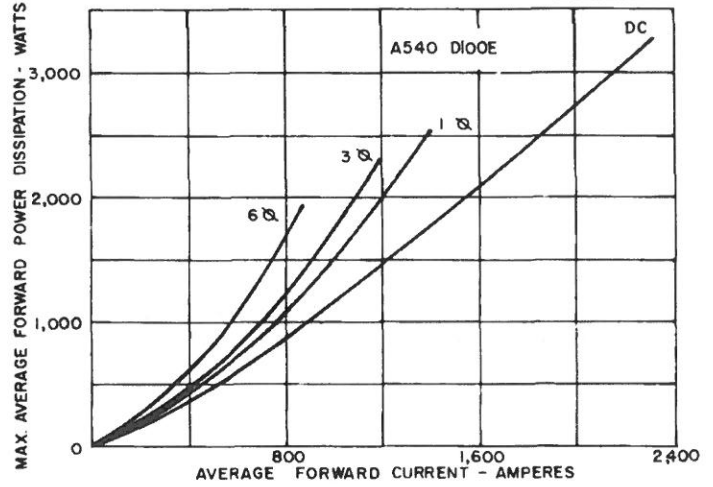

2. AVERAGE FORWARD POWER DISSIPATION VERSUS AVERAGE FORWARD CURRENT

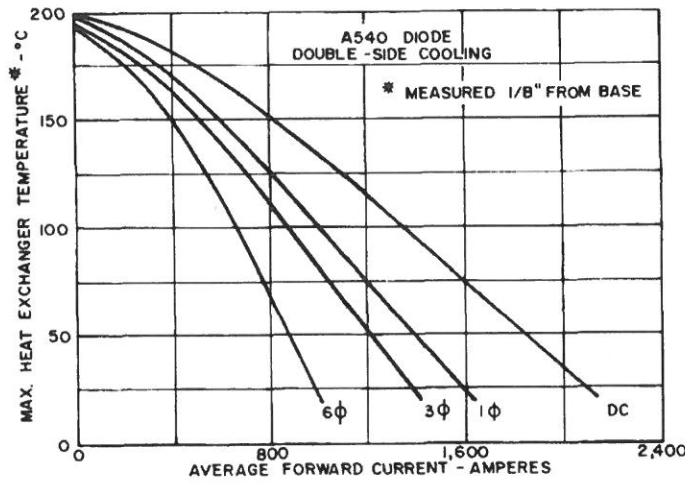

3. MAXIMUM HEAT EXCHANGER TEMPERATURE VERSUS AVERAGE FORWARD CURRENT FOR DOUBLE-SIDE COOLING

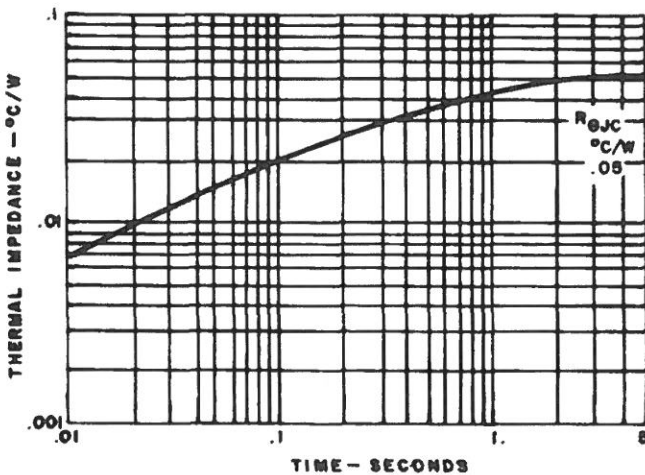

4. TRANSIENT THERMAL IMPEDANCE - JUNCTION-TO-CASE

NOTES:

1. Power "D" adds .01°C/W to account for both case to dissipator interfaces, when properly mounted; e.g., $R_{\theta JS} = .06^\circ\text{C/W}$. See Mounting Instructions.
2. DC Thermal Impedance is based on average full cycle junction temperature. Instantaneous junction temperature may be calculated using the following modifications.
 - end of conducting portion of cycle
 - 120° sq. wave add .0065°C/W along entire curve
 - 180° sq. wave add .0047°C/W along entire curve
 - 180° sine wave add .0026°C/W along entire curve
 - end of full cycle
 - any wave, subtract .0026°C/W along entire curve

A540

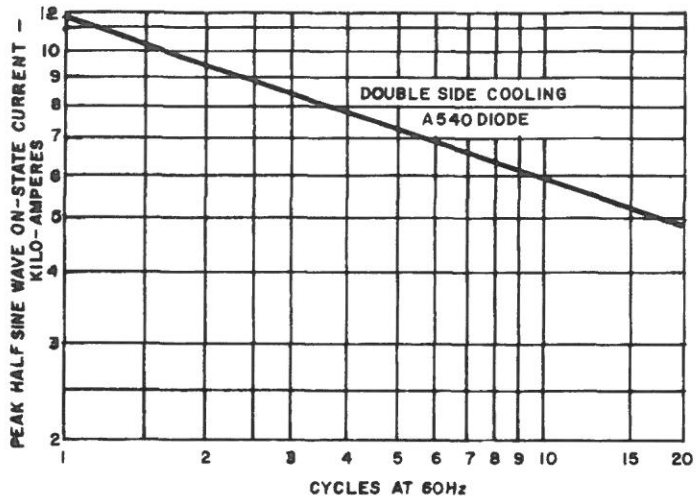

5. MAXIMUM SURGE CURRENT FOLLOWING RATED LOAD CONDITIONS

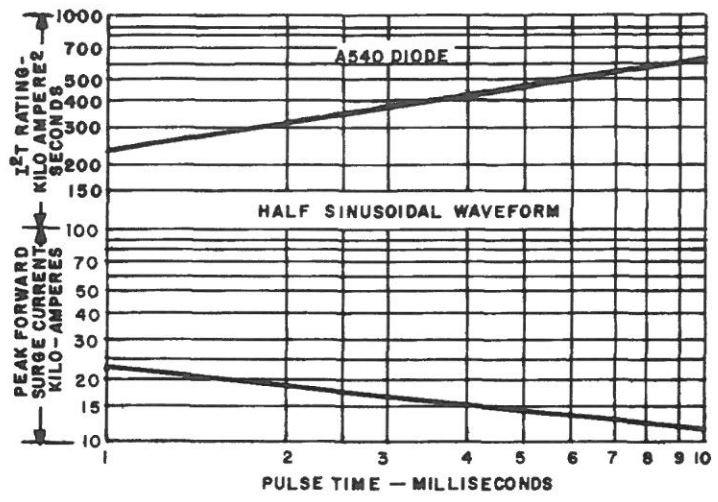

6. SUBCYCLE PEAK SURGE FORWARD CURRENT AND I²t RATING FOLLOWING RATED LOAD CONDITIONS

OUTLINE DRAWING

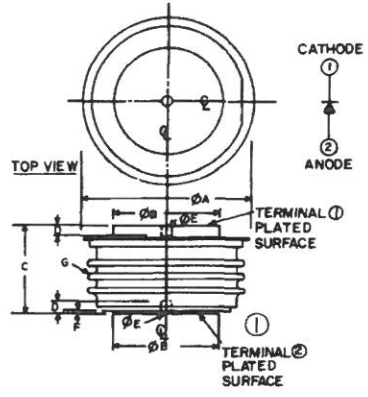

NOTE:
1. GLAZED CERAMIC INSULATOR
WITH 1.00 INCH MIN. SURFACE
CREEPAGE (25.40 mm)

SYMBOL	INCHES		MILLIMETERS		NOTE
	MIN	MAX	MIN	MAX	
φA	—	2.000	—	50.80	
φB	1.240	1.260	31.50	32.00	
C	1.000	1.060	25.40	26.92	
D	.080	—	2.03	—	
φE	0.136	0.146	3.45	3.71	
F	.034	—	0.86	—	
G					1