

Features

- Single +5 volt ($\pm 5\%$) power supply.
- Alphanumeric and limited graphics capabilities.
- Fully programmable display (rows, columns, blanking, etc.).
- Non-interlaced scan.
- 50/60 Hz operation.
- Fully programmable cursor.
- External light pen capability.
- Capable of addressing up to 16K character Video Display RAM.
- No DMA required.
- Pin-compatible with MC6845.
- Row/Column or straight-binary addressing for Video Display RAM.
- Internal status register.
- Video Display RAM may be configured as part of microprocessor memory field or independently slaved to 6545 (Transparent Addressing).

Description

The SY6545-1 is a CRT Controller intended to provide capability for interfacing any microprocessor to CRT or TV-type raster scan displays. A unique feature is the inclu-

sion of several modes of operation, so that the system designer can configure the system with a wide assortment of techniques.

Pin Configuration

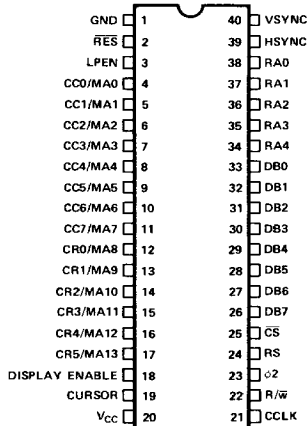

Interface Diagram

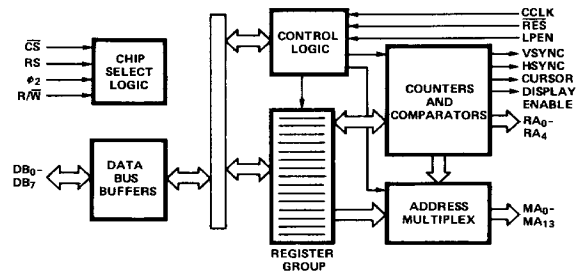

Absolute Maximum Ratings*

Supply Voltage, V_{CC}	-0.3V to +7.0V
Input/Output Voltage, V_{IN}	-0.3V to +7.0V
Operating Temperature, T_{OP}	0°C to 70°C
Storage Temperature, T_{STG}	-55°C to 150°C

Comment*

Stresses above those listed under "Absolute Maximum Ratings" may cause permanent damage to the device. These are stress ratings only. Functional operation of this device at these or any other conditions above those indicated in the operational sections of this specification is not implied and exposure to absolute maximum rating conditions for extended periods may affect device reliability.

All inputs contain protection circuitry to prevent damage due to high static discharges. Care should be exercised to prevent unnecessary application of voltages in excess of the allowable limits.

D.C. Characteristics ($V_{CC} = 5.0V \pm 5\%$, $GND = 0V$, $T_A = 0 - 70^\circ C$, unless otherwise noted)

Symbol	Characteristic	Min.	Max.	Unit
V_{IH}	Input High Voltage	2.4	V_{CC}	V
V_{IL}	Input Low Voltage	-0.3	0.4	V
I_{IN}	Input Leakage ($\phi 2, R/\bar{w}, \bar{RES}, \bar{CS}, RS, LPEN, CCLK$)	-	2.5	μA
I_{TSI}	Three-State Input Leakage (DB0-DB7) $V_{IN} = 0.4$ to $2.4V$	-	± 10.0	μA
V_{OH}	Output High Voltage $I_{LOAD} = -205\mu A$ (DB0-DB7) $I_{LOAD} = -100\mu A$ (all others)	2.4	-	V
V_{OL}	Output Low Voltage $I_{LOAD} = 1.6mA$	-	0.4	V
P_D	Power Dissipation ($T_A = 25^\circ C$), $V_{CC} = 5.25V$	-	900	mW
C_{IN}	Input Capacitance $\phi 2, R/\bar{w}, \bar{RES}, \bar{CS}, RS, LPEN, CCLK$ DB0-DB7	-	10.0 12.5	pF pF
C_{OUT}	Output Capacitance	-	10.0	pF

Test Load

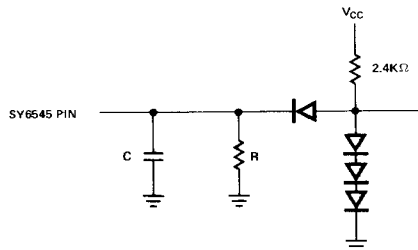

R = 11KΩ FOR DB0-DB7
 R = 24KΩ FOR ALL OTHER OUTPUTS
 C = 130 pF TOTAL FOR D0-D7
 C = 30 pF ALL OTHER OUTPUTS

MPU Bus Interface Characteristics

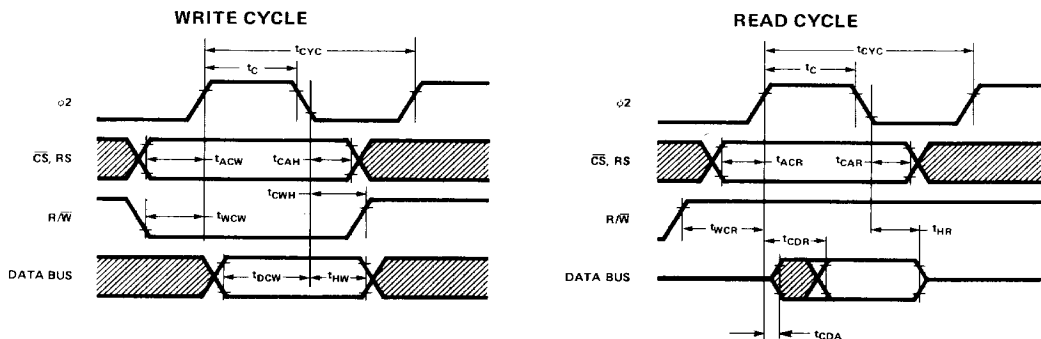

Write Timing Characteristics

(V_{CC} = 5.0V ± 5%, T_A = 0–70°C, unless otherwise noted)

Symbol	Characteristic	SY6545-1		SY6545A-1		Unit
		Min.	Max.	Min.	Max.	
t _{CYC}	Cycle Time	1.0	—	0.5	—	μs
t _C	φ2 Pulse Width	440	—	200	—	ns
t _{ACW}	Address Set-Up Time	180	—	90	—	ns
t _{CAH}	Address Hold Time	0	—	0	—	ns
t _{WCW}	R/ \bar{W} Set-Up Time	180	—	90	—	ns
t _{CWH}	R/ \bar{W} Hold Time	0	—	0	—	ns
t _{DCW}	Data Bus Set-Up Time	265	—	100	—	ns
t _{HW}	Data Bus Hold Time	10	—	10	—	ns

(t_r and t_f = 10 to 30 ns)

Read Timing Characteristics

(V_{CC} = 5.0V ± 5%, T_A = 0–70°C, unless otherwise noted)

Symbol	Characteristic	SY6545-1		SY6545A-1		Unit
		Min.	Max.	Min.	Max.	
t _{CYC}	Cycle Time	1.0	—	0.5	—	μs
t _C	φ2 Pulse Width	440	—	200	—	ns
t _{ACR}	Address Set-Up Time	180	—	90	—	ns
t _{CAR}	Address Hold Time	0	—	0	—	ns
t _{WCR}	R/ \bar{W} Set-Up Time	180	—	90	—	ns
t _{CDR}	Read Access Time (Valid Data)	—	340	—	150	ns
t _{HR}	Read Hold Time	10	—	10	—	ns
t _{CDA}	Data Bus Active Time (Invalid Data)	40	—	40	—	ns

(t_r and t_f = 10 to 30 ns)

Memory and Video Interface Characteristics

($V_{CC} = 5.0V \pm 5\%$, $T_A = 0$ to $70^\circ C$, unless otherwise noted)

System Timing

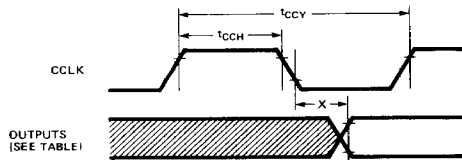

Transparent Addressing (ϕ_1/ϕ_2 Interleaving)

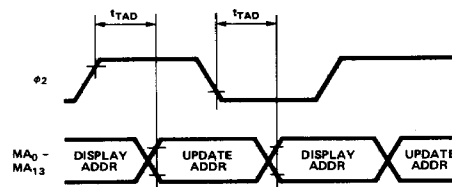

Symbol	Characteristic	SY6545-1		SY6545A-1		Unit
		Min.	Max.	Min.	Max.	
t_{CCY}	Character Clock Cycle Time	0.40	—	0.40	—	μs
t_{CCH}	Character Clock Pulse Width	200	—	200	—	ns
(X) t_{MAD}	MA0-MA13 Propagation Delay	—	300	—	300	ns
(X) t_{RAD}	RA0-RA4 Propagation Delay	—	300	—	300	ns
(X) t_{DTD}	DISPLAY ENABLE Propagation Delay	—	450	—	450	ns
(X) t_{HSD}	HSYNC Propagation Delay	—	450	—	450	ns
(X) t_{VSD}	VSYNC Propagation Delay	—	450	—	450	ns
(X) t_{CDD}	CURSOR Propagation Delay	—	450	—	450	ns
t_{TAD}	MA0-MA13 Switching Delay	—	200	—	200	ns

Light Pen Strobe Timing

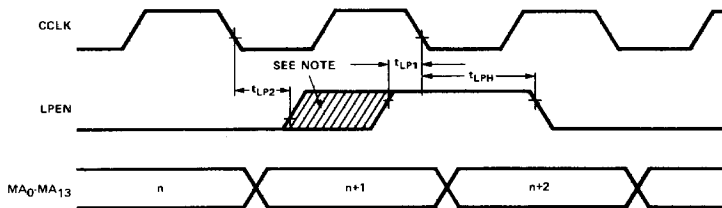

NOTE: "Safe" time position for LPEN positive edge to cause address n+2 to load into Light Pen Register.
 t_{LP2} and t_{LP1} are time positions causing uncertain results.

Symbol	Characteristic	SY6545-1		SY6545A-1		Unit
		Min.	Max.	Min.	Max.	
t_{LPH}	LPEN Hold Time	150	—	150	—	ns
t_{LP1}	LPEN Setup Time	20	—	20	—	ns
t_{LP2}	CCLK to LPEN Delay	0	—	0	—	ns

$t_r, t_f = 20$ ns (max)

MICRO-PROCESSORS

MPU Interface Signal Description

$\phi 2$ (Clock)

The input clock is the system $\phi 2$ clock and is used to trigger all data transfers between the system microprocessor and the SY6545. Since there is no maximum limit to the allowable $\phi 2$ cycle time, it is not necessary for it to be a continuous clock. This capability permits the SY6545 to be easily interfaced to non-6500-compatible microprocessors.

R/\bar{W} (Read/Write)

The R/\bar{W} signal is generated by the microprocessor and is used to control the direction of data transfers. A high on the R/\bar{W} pin allows the processor to read the data supplied by the SY6545; a low on the R/\bar{W} pin allows a write to the SY6545.

\bar{CS} (Chip Select)

The Chip Select input is normally connected to the processor address bus either directly or through a decoder. The SY6545 is selected when \bar{CS} is low.

RS (Register Select)

The Register Select input is used to access internal registers. A low on this pin permits writes into the Address Register and reads from the Status Register. The contents of the Address Register is the identity of the register accessed when RS is high.

DB₀-DB₇ (Data Bus)

The DB₀-DB₇ pins are the eight data lines used for transfer of data between the processor and the SY6545. These lines are bi-directional and are normally high-impedance except during read cycles when the chip is selected.

Video Interface Signal Description

HSYNC (Horizontal Sync)

The HSYNC signal is an active-high output used to determine the horizontal position of displayed text. It may drive a CRT monitor directly or may be used for composite video generation. HSYNC time position and width are fully programmable.

VSYNC (Vertical Sync)

The VSYNC signal is an active-high output used to determine the vertical position of displayed text. Like HSYNC, VSYNC may be used to drive a CRT monitor or composite video generation circuits. VSYNC position and width are both fully programmable.

DISPLAY ENABLE

The DISPLAY ENABLE signal is an active-high output and is used to indicate when the SY6545 is generating active display information. The number of horizontal displayed characters and the number of vertical displayed characters are both fully programmable and together are used to generate the DISPLAY ENABLE signal.

DISPLAY ENABLE may be delayed by one character time by setting bit 4 of R8 to a "1".

CURSOR

The CURSOR signal is an active-high output and is used to indicate when the scan coincides with the programmed cursor position. The cursor position may be programmed to be any character in the address field. Furthermore, within the character, the cursor may be programmed to be any block of scan lines, since the start scan line and the end scan line are both programmable. The CURSOR position may be delayed by one character time by setting bit 5 of R8 to a "1".

LPEN

The LPEN signal is an edge-sensitive input and is used to load the internal Light Pen Register with the contents of the Refresh Scan Counter at the time the active edge occurs. The active edge of LPEN is the low-to-high transition.

CCLK

The CCLK signal is the character timing clock input and is used as the time base for all internal count/control functions.

\bar{RES}

The \bar{RES} signal is an active-low input used to initialize all internal scan counter circuits. When \bar{RES} is low, all internal counters are stopped and cleared, all scan and video outputs are low, and control registers are unaffected. \bar{RES} must stay low for at least one CCLK period. All scan timing is initiated when \bar{RES} goes high. In this way, \bar{RES} can be used to synchronize display frame timing with line frequency.

Memory Address Signal Description

MA0-MA13 (Video Display RAM Address Lines)

These signals are active-high outputs and are used to address the Video Display RAM for character storage and display operations. The starting scan address is fully programmable and the ending scan address is determined by the total number of characters displayed, which is also programmable, in terms of characters/line and lines/frame.

There are two selectable address modes for MA0-MA13:

- Binary
 - Characters are stored in successive memory locations. Thus, the software must be developed so that row and column co-ordinates are translated to sequentially-numbered addresses for video display memory operations.
- Row/Column
 - In this mode, MA0-MA7 function as column addresses CC0-CC7, and MA8-MA13, as row addresses CR0-CR5. In this case, the software may handle addresses in terms of row and column locations, but additional

address compression circuits are needed to convert CC0-CC7 and CR0-CR5 into a memory-efficient binary scheme.

RA0-RA4 (Raster Address Lines)

These signals are active-high outputs and are used to select each raster scan within an individual character row. The number of raster scan lines is programmable and determines the character height, including spaces between character rows.

The high-order line, RA4, is unique in that it can also function as a strobe output pin when the SY6545 is programmed to operate in the "Transparent Address Mode". In this case the strobe is an active-high output and is true at the time the Video Display RAM update address is gated on to the address lines, MA0-MA13. In this way, updates and readouts of the Video Display RAM can be made under control of the SY6545 with only a small amount of external circuitry.

Description of Internal Registers

Figure 1 illustrates the format of a typical video display and is necessary to understand the functions of the various SY6545 internal registers. Figure 2 illustrates vertical and horizontal timing. Figure 3 summarizes the internal registers and indicates their address selection and read/write capabilities.

Address Register

This is a 5-bit register which is used as a "pointer" to direct SY6545 data transfers to and from the system MPU. Its contents is the number of the desired register (0-31). When RS is low, then this register may be loaded; when RS is high, then the register selected is the one whose identity is stored in this register.

Status Register

This 3-bit register is used to monitor the status of the

CRTC, as follows:

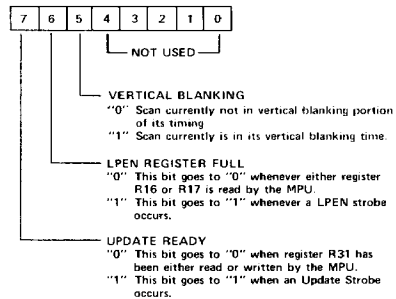

Horizontal Total (R0)

This 8-bit register contains the total of displayed and non-displayed characters, minus one, per horizontal line. The frequency of HSYNC is thus determined by this register.

Horizontal Displayed (R1)

This 8-bit register contains the number of displayed characters per horizontal line.

Horizontal Sync Position (R2)

This 8-bit register contains the position of the HSYNC on the horizontal line, in terms of the character location number on the line. The position of the HSYNC determines the left-to-right location of the displayed text on the video screen. In this way, the side margins are adjusted.

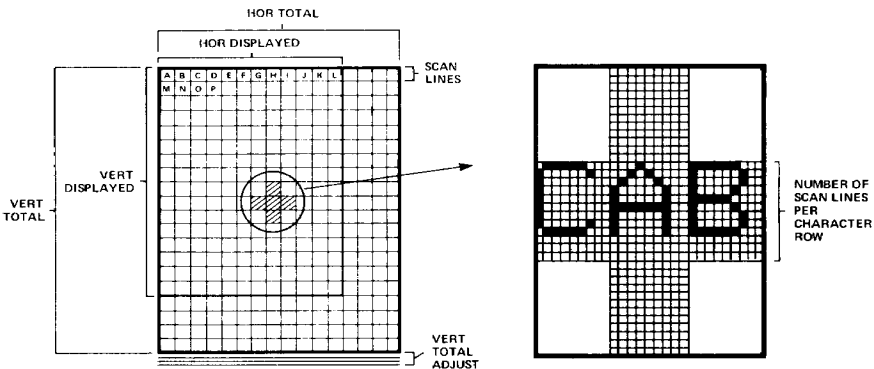

Figure 1. Video Display Format

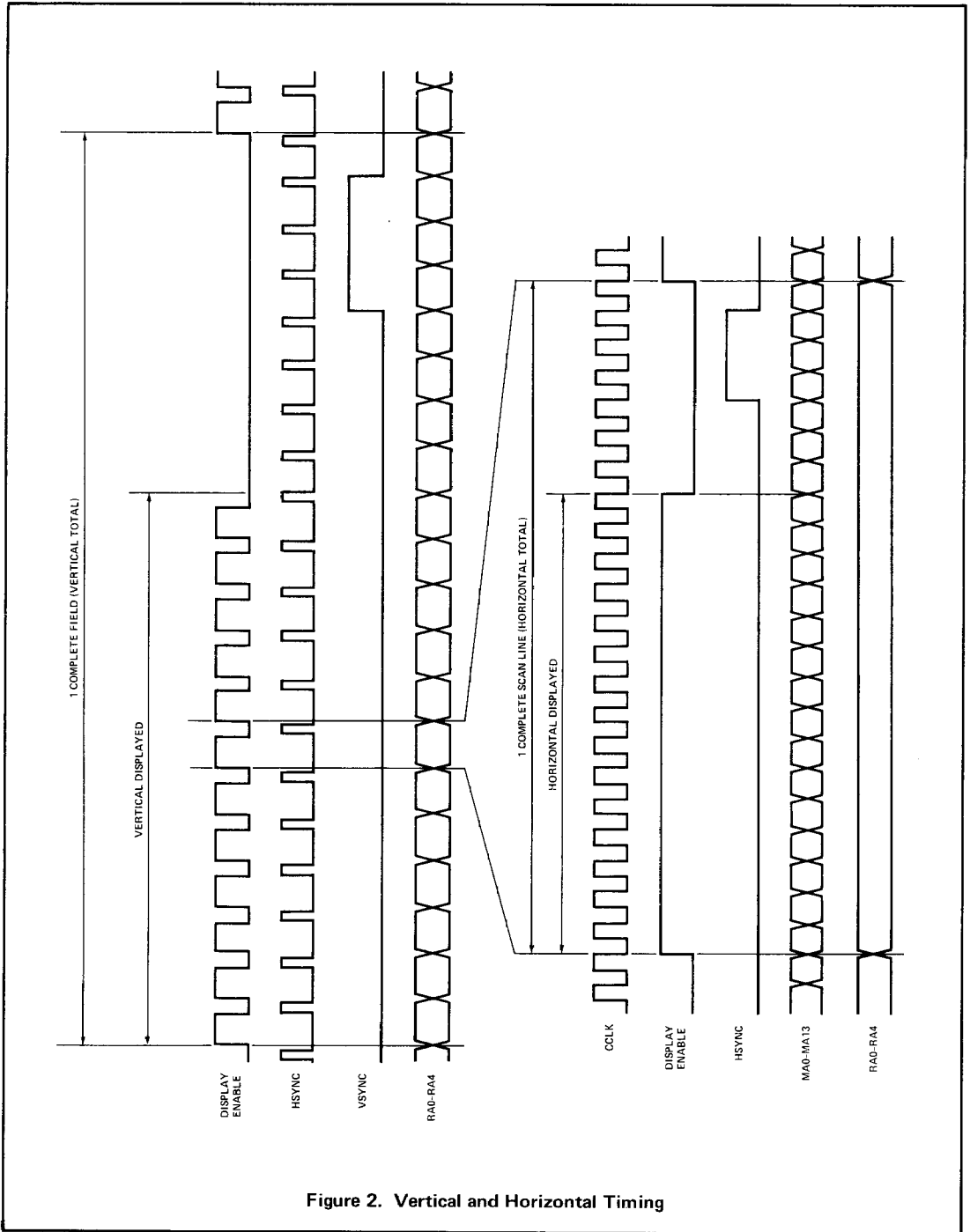
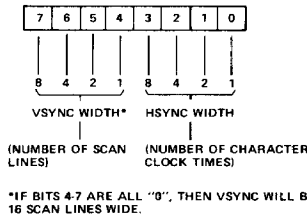

Figure 2. Vertical and Horizontal Timing

Horizontal and Vertical SYNC Widths (R3)

This 8-bit register contains the widths of both HSYNC and VSYNC, as follows:



Control of these parameters allows the SY6545 to be

interfaced to a variety of CRT monitors, since the HSYNC and VSYNC timing signals may be accommodated without the use of external one-shot timing.

Vertical Total (R4)

The Vertical Total Register is a 7-bit register containing the total number of character rows in a frame, minus one. This register, along with R5, determines the overall frame rate, which should be close to the line frequency to ensure flicker-free appearance. If the frame time is adjusted to be longer than the period of the line frequency, then RES may be used to provide absolute synchronism.

CS	RS	Address Reg.					Reg. No.	Register Name	Stored Info.	RD	WR	Register Bit									
		4	3	2	1	0						7	6	5	4	3	2	1	0		
1	-	-	-	-	-	-	-														
0	0	-	-	-	-	-	-	Address Reg.	Reg. No.		✓			A ₄	A ₃	A ₂	A ₁	A ₀			
0	0	-	-	-	-	-	-	Status Reg.		✓		U	L	V							
0	1	0	0	0	0	0	R0	Horiz. Total - 1	# Charac.		✓	●	●	●	●	●	●	●	●	●	
0	1	0	0	0	0	1	R1	Horiz. Displayed	# Charac.		✓	●	●	●	●	●	●	●	●	●	
0	1	0	0	0	1	0	R2	Horiz. Sync Position	# Charac.		✓	●	●	●	●	●	●	●	●	●	
0	1	0	0	0	1	1	R3	VSYNC, HSYNC Widths	# Scan Lines and # Char. Times		✓	V ₃	V ₂	V ₁	V ₀	H ₃	H ₂	H ₁	H ₀		
0	1	0	0	1	0	0	R4	Vert. Total - 1	# Charac. Row		✓			●	●	●	●	●	●		
0	1	0	0	1	0	1	R5	Vert. Total Adjust	# Scan Lines		✓			●	●	●	●	●	●		
0	1	0	0	1	1	0	R6	Vert. Displayed	# Charac. Rows		✓			●	●	●	●	●	●		
0	1	0	0	1	1	1	R7	Vert. Sync Position	# Charac. Rows		✓			●	●	●	●	●	●		
0	1	0	1	0	0	0	R8	Mode Control			✓	●	●	●	●	●	●	●	●		
0	1	0	1	0	0	1	R9	Scan Lines - 1	# Scan Lines		✓			●	●	●	●	●	●		
0	1	0	1	0	1	0	R10	Cursor Start	Scan Line No.		✓			B ₁	B ₀	●	●	●	●		
0	1	0	1	0	1	1	R11	Cursor End	Scan Line No.		✓			●	●	●	●	●	●		
0	1	0	1	1	0	0	R12	Display Start Addr (H)			✓			●	●	●	●	●	●		
0	1	0	1	1	0	1	R13	Display Start Addr (L)			✓	●	●	●	●	●	●	●	●		
0	1	0	1	1	1	0	R14	Cursor Position (H)		✓	✓			●	●	●	●	●	●		
0	1	0	1	1	1	1	R15	Cursor Position (L)		✓	✓	●	●	●	●	●	●	●	●		
0	1	1	0	0	0	0	R16	Light Pen Reg (H)		✓				●	●	●	●	●	●		
0	1	1	0	0	0	1	R17	Light Pen Reg (L)		✓		●	●	●	●	●	●	●	●		
0	1	1	0	0	1	0	R18	Update Address Reg (H)			✓			●	●	●	●	●	●		
0	1	1	0	0	1	1	R19	Update Address Reg (L)			✓	●	●	●	●	●	●	●	●		
0	1	1	1	1	1	1	R31	Dummy Location													

- Notes:
- Designates binary bit
 - ▨ Designates unused bit. Reading this bit is always "0", except for R31, which does not drive the data bus at all, and for CS = "1" which operates likewise.

Figure 3. Internal Register Summary

MICRO PROCESSORS

Vertical Total Adjust (R5)

The Vertical Total Adjust Register is a 5-bit write only register containing the number of additional scan lines needed to complete an entire frame scan and is intended as a fine adjustment for the video frame time.

Vertical Displayed (R6)

This 7-bit register contains the number of displayed character rows in each frame. In this way, the vertical size of the displayed text is determined.

Vertical Sync Position (R7)

This 7-bit register is used to select the character row time at which the VSYNC pulse is desired to occur and, thus, is used to position the displayed text in the vertical direction.

Mode Control (R8)

This register is used to select the operating modes of the SY6545 and is outlined as follows:

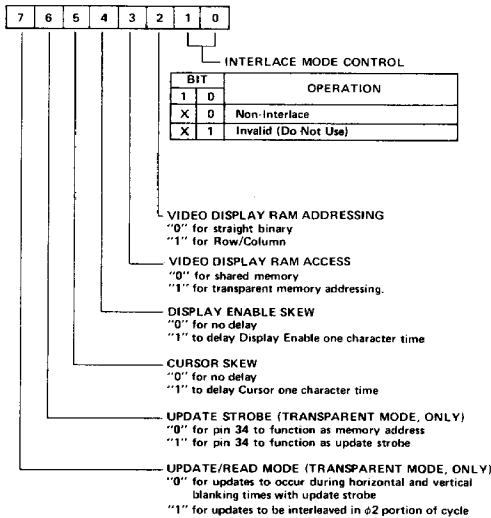

Scan Line (R9)

This 5-bit register contains the number of scan lines per character row, including spacing, minus 1.

Cursor Start (R10) and Cursor End (R11)

These 5-bit registers select the starting and ending scan lines for the cursor. In addition, bits 5 and 6 of R10 are used to select the cursor mode, as follows:

BIT		CURSOR MODE
6	5	
0	0	No Blinking
0	1	No Cursor
1	0	Blink at 1/16 field rate
1	1	Blink at 1/32 field rate

Note that the ability to program both the start and end scan line for the cursor enables either block cursor or underline to be accommodated. Registers R14 and R15 are used to control the character position of the cursor over the entire 16K address field.

Display Start Address High (R12) and Low (R13)

These registers together comprise a 14-bit register whose contents is the memory address of the first character of the displayed scan (the character on the top left of the video display, as in Figure 1). Subsequent memory addresses are generated by the SY6545 as a result of CCLK input pulses. Scrolling of the display is accomplished by changing R12 and R13 to the memory address associated with the first character of the desired line of text to be displayed first. Entire pages of text may be scrolled or changed as well via R12 and R13.

Cursor Position High (R14) and Low (R15)

These registers together comprise a 14-bit register whose contents is the memory address of the current cursor position. When the video display scan counter (MA lines) matches the contents of this register, and when the scan line counter (RA lines) falls within the bounds set by R10 and R11, then the CURSOR output becomes active. Bit 5 of the Mode Control Register (R8) may be used to delay the CURSOR output by a full CCLK time to accommodate slow access memories.

LPEN High (R16) and Low (R17)

These registers together comprise a 14-bit register whose contents is the light pen strobe position, in terms of the video display address at which the strobe occurred. When the LPEN input changes from low to high, then, on the next negative-going edge of CCLK, the contents of the internal scan counter is stored in registers R16 and R17.

Update Address High (R18) and Low (R19)

These registers together comprise a 14-bit register whose contents is the memory address at which the next read or update will occur (for transparent address mode, only). Whenever a read/update occurs, the update location automatically increments to allow for fast updates or readouts of consecutive character locations. This is described elsewhere in this document.

Dummy Location (R31)

This register does not store any data, but is required to detect when transparent addressing updates occur. This is necessary to increment the Update Address Register and to set the Update Ready bit in the status register.

Detailed Description of Operation

Register Formats

Register pairs R12/R13, R14/R15, R16/R17, and R18/R19 are formatted in one of two ways:

1. Straight binary if register R8, bit 2 is a "0".
2. Row/Column if register R8, bit 2 is a "1". In this case the low byte is the Character Column and the high byte is the Character Row.

Figure 4 illustrates the address sequence for the video display control for each mode.

Note from Figure 4 that the straight-binary mode has the advantage that all display memory addresses are stored in a continuous memory block, starting with address 0 and ending at 1919. The disadvantage with this method is that, if it is desired to change a displayed character location, the row and column identity of the location must be converted to its binary address before the memory may be written. The row/column mode, on the other hand, does not need to undergo this conversion. However, memory is not used as efficiently, since the memory addresses are not continuous, but gaps exist. This requires that the system be equipped with more memory than is actually used and this extra memory is wasted. Alternatively, address compression logic may be employed to translate the row/column format into a continuous address block.

In this way, the user may select whichever mode is best for the given application. The trade-offs between the modes are software versus hardware. Straight-binary mode minimizes hardware requirements and row/column requires minimum software.

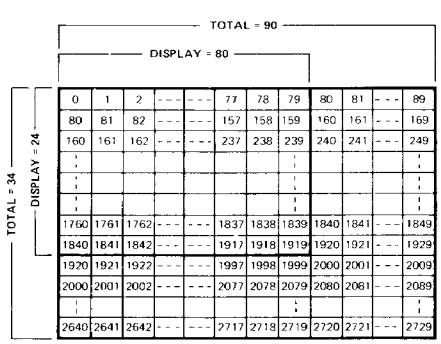

STRAIGHT BINARY ADDRESSING SEQUENCE

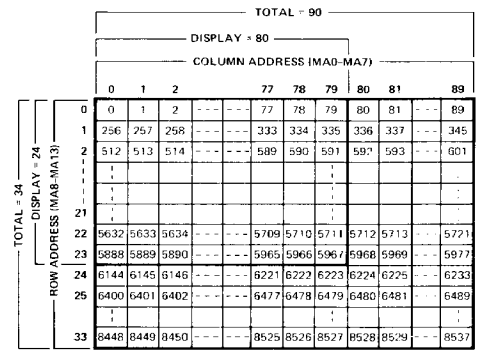

ROW/COLUMN ADDRESSING SEQUENCE

Figure 4. Display Address Sequences (with Start Address = 0) for 80 x 24 Example

MICRO-PROCESSORS

Video Display RAM Addressing

There are two modes of addressing for the video display memory:

1. Shared Memory

In this mode the memory is shared between the MPU address bus and the SY6545 address bus. For this case, memory contention must be resolved by means of external timing and control circuits. Both the MPU and the SY6545 must have access to the video display RAM and the contention circuits must resolve this

multiple access requirement. Figure 5 illustrates the system configuration.

2. Transparent Memory Addressing

For this mode, the display RAM is not directly accessible by the MPU, but is controlled entirely by the SY6545. All MPU accesses are made via the SY6545 and a small amount of external circuits. Figure 6 shows the system configuration for this approach.

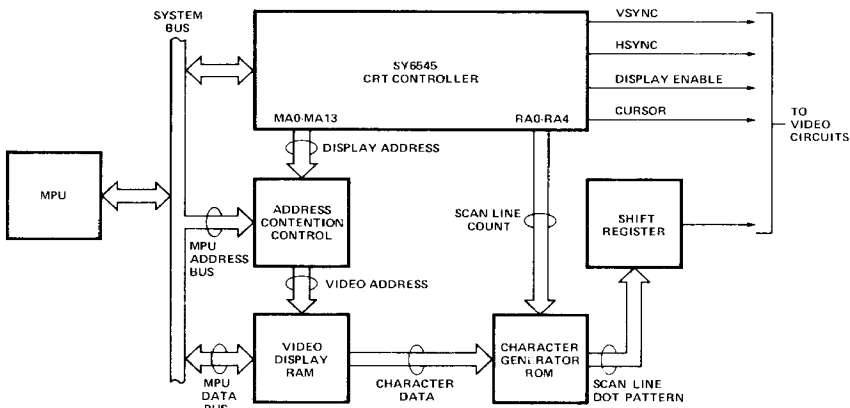

Figure 5. Shared Memory System Configuration

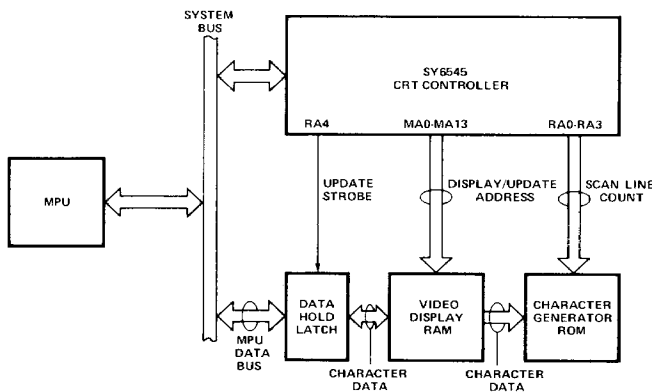

Figure 6. Transparent Memory Addressing System Configuration (Data Hold Latch needed for Horizontal/Vertical Blanking updates, only).

Memory Contention Schemes for Shared Memory Addressing

From the diagram of Figure 5, it is clear that both the SY6545 and the system MPU must be capable of addressing the video display memory. The SY6545 repetitively fetches character information to generate the video signals in order to keep the screen display active. The MPU occasionally accesses the memory to change the displayed information or to read out current data characters. Three ways of resolving this dual-contention requirement are apparent:

- **MPU Priority**

In this technique, the address lines to the video display memory are normally driven by the SY6545 unless the MPU needs access, in which case the MPU addresses immediately override those from the SY6545 and the MPU has immediate access.

- **$\phi 1/\phi 2$ Memory Interleaving**

This method permits both the SY6545 and the MPU access to the video display memory by time-sharing via the system $\phi 1$ and $\phi 2$ clocks. During the $\phi 1$ portion of each cycle (the time when $\phi 2$ is low), the SY6545 address outputs are gated to the video display memory. In the $\phi 2$ time, the MPU address lines are switched in. In this way, both the SY6545 and the MPU have unimpeded access to the memory. Figure 7 illustrates the timings.

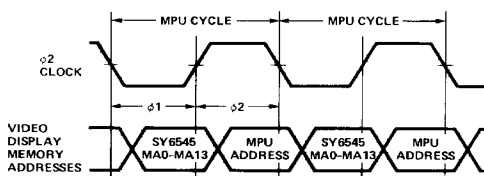

Figure 7. $\phi 1/\phi 2$ Interleaving

- **Vertical Blanking**

With this approach, the address circuitry is identical to the case for MPU Priority updates. The only difference is that the Vertical Retrace status bit (bit 5 of the Status Register) is used by the MPU so that access to the video display memory is only made during vertical blanking time (when bit 5 is a "1"). In this way, no visible screen perturbations result.

Transparent Memory Addressing

In this mode of operation, the video display memory address lines are not switched by contention circuits, but are generated by the SY6545. In effect, the contention is handled by the SY6545. As a result, the schemes for accomplishing MPU memory access are different:

- **$\phi 1/\phi 2$ Interleaving**

This mode is similar to the Interleave mode used with shared memory. In this case, however, the $\phi 2$ address is generated from the Update Address Register (Registers R18 and R19) in the SY6545. Thus, the MPU must first load the address to be accessed into R18/R19 and then this address is always gated onto the MA lines during $\phi 2$. Figure 8 shows the timing.

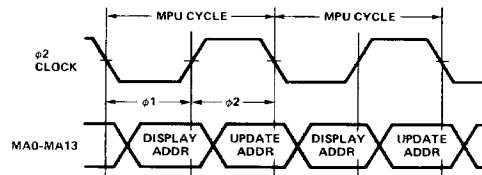

Figure 8. $\phi 1/\phi 2$ Transparent Interleaving

- **Horizontal/Vertical Blanking**

In this mode, the Update Address is loaded by the MPU, but is only gated onto the MA lines during horizontal or vertical blank times, so memory accesses do not interfere with the display appearance. To signal when the update address is on the MA lines, an update strobe (STB) is provided as an alternate function of pin 34. Data hold latches are necessary to temporarily retain the character to be stored until the retrace time occurs. In this way, the system MPU is not halted waiting for the blanking time to arrive. Figure 9 illustrates the address and strobe timing for this mode.

Transparent address modes are quite complex and offer significant advantages in system implementation. The details of their application are covered thoroughly in related Technical Notes available from Synertek.

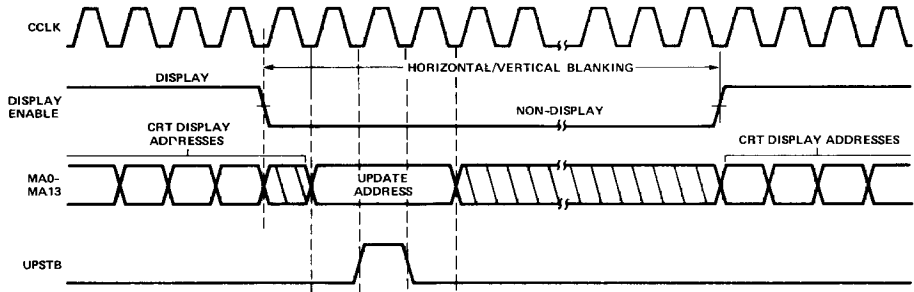

Figure 9. Retrace Update Timings

Cursor and Display Enable Skew Control

Bits 4 and 5 of the Mode Control register (R8) are used to delay the Display Enable and Cursor outputs, respectively. Figure 10 illustrates the effect of the delays.

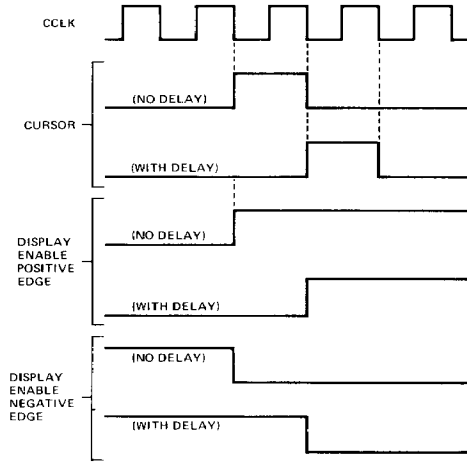

Figure 10. Cursor and Display Enable Skew

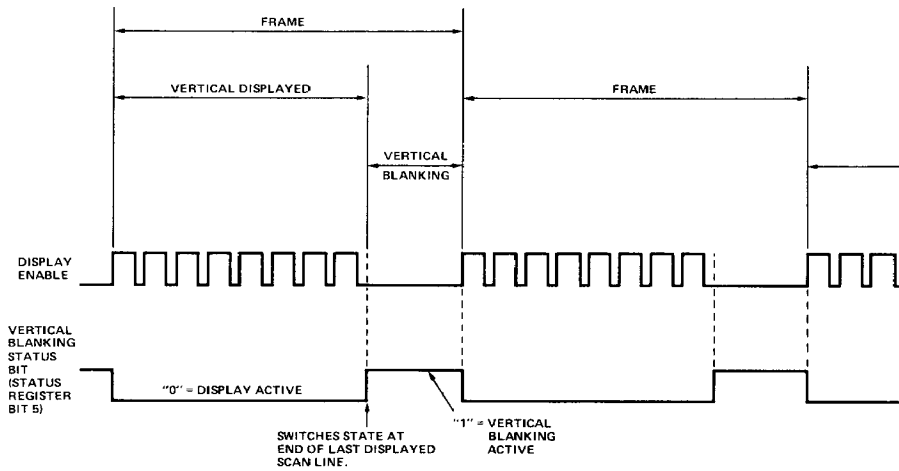

Figure 11. Operation of Vertical Blanking Status Bit

Package Availability 40 Pin Plastic
 40 Pin Ceramic
 40 Pin Cerdip

Ordering Information

Part Number	Package	
SYP6545-1	Plastic	1 MHz
SYC6545-1	Ceramic	1 MHz
SYD6545-1	Cerdip	1 MHz
SYP6545A-1	Plastic	2 MHz
SYC6545A-1	Ceramic	2 MHz
SYD6545A-1	Cerdip	2 MHz

MICRO-PROCESSORS