

Model **E2F**
PROXIMITY SWITCH

INSTRUCTION MANUAL

AVAILABLE TYPES

Table 1

Output form (short-circuit protection)	Type	Shielded					
		O.D.	M8	M12	M18	M30	
DC switching type	S.C.P. provided	NPN	NO	E2F - X1R5E1	E2F - X2E1	E2F - X5E1	E2F - X10E1
			NC	E2F - X1R5E2	E2F - X2E2	E2F - X5E2	E2F - X10E2
		PNP	NO	E2F - X1R5F1	E2F - X2F1	E2F - X5F1	E2F - X10F1
			NC	E2F - X1R5F2	E2F - X2F2	E2F - X5F2	E2F - X10F2
AC switching type	S.C.P. not provided	NO	E2F - X1R5Y1	E2F - X2Y1	E2F - X5Y1	E2F - X10Y1	
		NC	E2F - X1R5Y2	E2F - X2Y2	E2F - X5Y2	E2F - X10Y2	
		NO	—	—	E2F - X5Y1 - 53	E2F - X10Y1 - 53	
		NC	—	—	E2F - X5Y2 - 53	E2F - X10Y2 - 53	

NOTE (1) Add suffix "G" to the type name when placing your order for European models with colored cables conforming to CENELEC standard (EN50044). Refer to Table 5 in CONNECTIONS for a comparisons of the standard types shown above and types with the suffix "G".
(2) When ordering AC switching type conforming to UL and CSA standards, add suffix code "US".

OMRON TATEISI ELECTRONICS CO.

DIMENSIONS [Unit: mm]

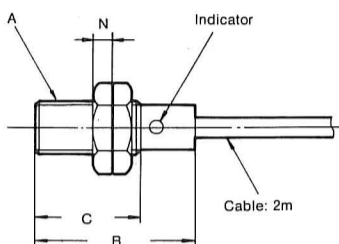

Table 2

Type	A	B	C	N
E2F - X1R5E(F)□	M8P=1.0	30	20	4
E2F - X1R5Y□	M8P=1.0	40	30	4
E2F - X2E(F)□	M12P=1.0	35	24	4
E2F - X2Y□	M12P=1.0	40	29	4

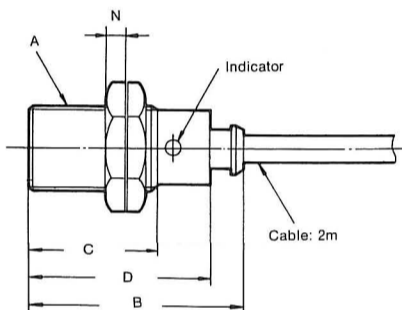

Table 3

Type	A	B	C	D	N
E2F - X5E(F)□	M18P=1.0	47	29	40	4
E2F - X5Y□	M18P=1.0	47	29	40	4
E2F - X5Y□-53	M18P=1.0	57	38	48	4
E2F - X10E(F)□	M30P=1.5	57	38	50	5
E2F - X10Y□	M30P=1.5	57	38	50	5
E2F - X10Y□-53	M30P=1.5	57	38	50	5

Table 4
NOTE:
Polyvinyl chloride insulated cable

E2F - X1R5□	3-0.14mm ² OD: 3.5mm Standard length: 2m
E2F - X2E(F)□ E2F - X5E(F)□ E2F - X10E(F)□	3-0.5mm ² OD: 6mm Standard length: 2m
E2F - X1R5Y□	2-0.14mm ² OD: 3.5mm Standard length: 2m
E2F - X2Y□ E2F - X5Y□ E2F - X5Y□-53 E2F - X10Y□ E2F - X10Y□-53	2-0.5mm ² OD: 6mm Standard length: 2m

• Extendable cable length is 200m max. (independently through metallic conduit).

CONNECTIONS

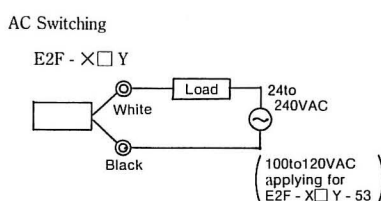
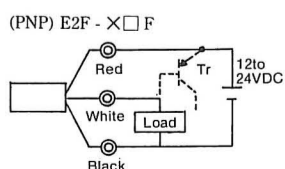
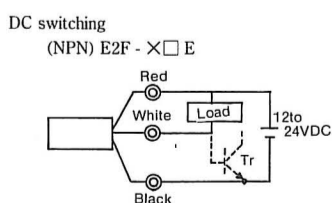

Refer to Table 5 for cable colors of E2F □□□ -G types.

Table 5: Comparison of cable colors

Type	E2F - □□□	E2F □□□ G	
DC switching type	+V	Red	Brown
	OV	Black	Blue
	Out-put	White	Black
AC switching type		White	Blue
		Black	Brown

HINTS ON CORRECT WIRING

• Note that direct connection of a proximity switch to the power supply without load may result in damage to the proximity switch. Therefore be sure to connect the switch through a load.

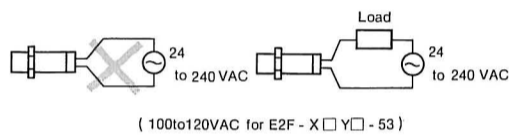

• If a high voltage or power line runs near the proximity switch cable be sure to wire the switch cable through a metallic conduit to prevent the switch from malfunctioning or damage.

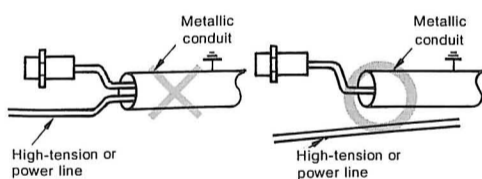

• Be sure to connect the proximity switch by processing its connecting cable end with a solderless terminal. (The solderless terminal is not supplied as an accessory.)

HINTS ON CORRECT USE

• Handling

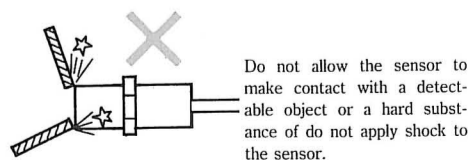
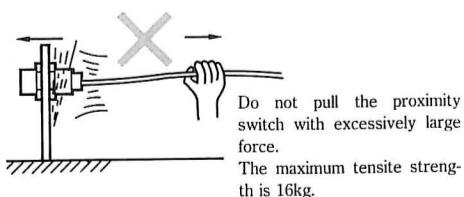
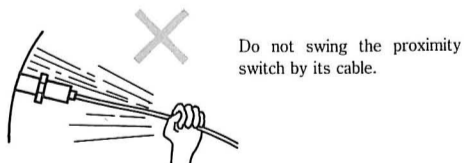

• Avoid using the proximity switch in an atmosphere of chemicals, especially strong alkali acid (such as nitric acid, chromic acid, hot concentrated sulfuric acid, etc.)

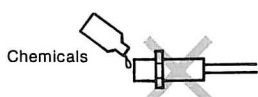

• How to determine setting distance (for stable operation)
• The detecting distance and setting distance of the proximity switch will vary depending on the shape size and material of a object to be detected. Therefore confirm the proper detecting and setting distance beforehand.

• When a detectable object is smaller than the standard detectable object (iron), the detecting distance will become shorter. However the detecting distance will not become longer even if an object larger than the standard detectable object is used.

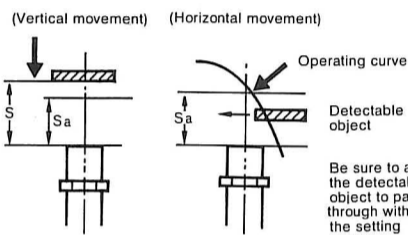

S: Detecting distance
Sa: Setting distance
Sa = 0~0.8S
(For horizontal movement refer to the operating range diagram shown in the catalog to confirm the proper setting distance.)

• Cable length
Extendable cable length is 200m max.

• Avoid using the proximity switch in outdoor locations (subject to direct sunlight, rainwater, etc.)

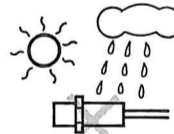

• Mounting

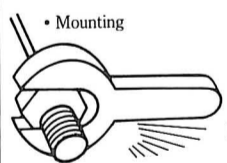

Do not tighten the proximity switch excessively.

Table 6

Type	Strength (kgf-cm)
E2F - X1R5□	6
E2F - X2□	10
E2F - X5□	20
E2F - X10□	20

• Effects of surrounding metals
When a metallic object other than the object to be detected exists in the area surrounding the detecting head the proximity switch may be affected by the surrounding metal and may not release properly. Even if the proximity switch releases properly, a change in the detecting distance may occur by temperature, etc. Therefore, be sure to provide a minimum distance from the surrounding metallic object, as specified in Table 7.

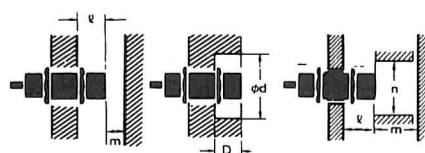

Table 7 Effects of surrounding metals [Unit: mmm]

Type Item	E2F-X1R5□	E2F-X2□	E2F-X5□	E2F-X10□
ℓ	0	0	0	0
d	8	12	18	30
D	0	0	0	0
m	4.5	8	20	40
n	12	18	27	45

• Mutual interference
When plural proximity switches are used, the juxtaposed switches may malfunction due to mutual interference. Therefore, be sure to provide a minimum distance between the two switches, as specified in Table 8.

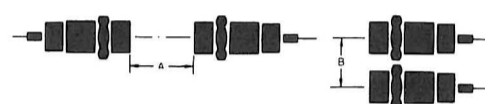

Table 8 Mutual interference [Unit: mm]

Type Item	E2F-X1R5□	E2F-X2□	E2F-X5□	E2F-X10□
A	20	30	50	100
B	15	20	35	70

MAINTENANCE AND INSPECTION

Check the following items when the proximity switch does not operate upon putting a detectable object close to the switch or when the proximity switch does not release upon keeping the detectable object away from the switch.

