

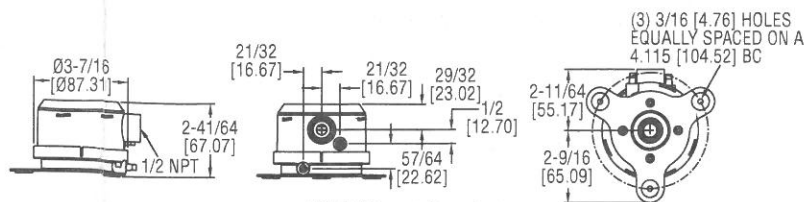

Series MS Magnesense® Differential Pressure Transmitter

Specifications - Installation and Operating Instructions



Wall Mount Bracket

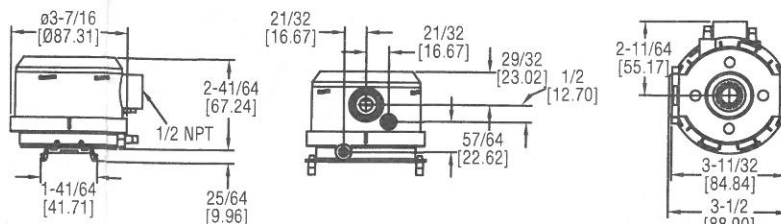
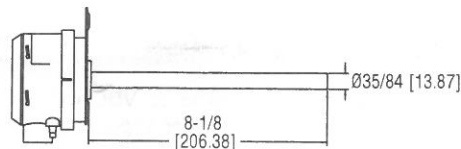

DIN Mount Bracket

The Series MS Magnesense® Differential Pressure Transmitter is an extremely versatile transmitter for monitoring pressure and air velocity. This compact package is loaded with features such as: field selectable English or metric ranges, field upgradeable LCD display, adjustable dampening of output signal (with optional display) and the ability to select a square root output for use with pitot tubes and other similar flow sensors.

Along with these features, magnetic sensing technology provides exceptional long term performance and enables the Magnesense® Differential Pressure Transmitter to be the solution for a myriad of pressure and air flow applications.

INSTALLATION

Mounting:

The transmitter should be mounted on a vertical surface with the connections directed down to prevent moisture from entering either the pressure ports or the electrical cable entry. The diaphragm must be vertical to minimize gravity effects on the diaphragm.

Mount the transmitter using #8 x 1/2" pan head sheet metal screws in the mounting flanges. Do not over tighten.

Duct Mount:

The transmitter should be mounted away from fans, corners, heating and cooling coils and other equipment that will effect the measurement of the pressure.

1. To mount the transmitter, drill a .562 (12.70) diameter hold into the duct.
2. Insert transmitter probe into the duct.
3. Mark location of three mounting holes on duct using mounting flange as template. Drill holes.
4. Attach mounting flange to duct with (3) #8 x 1/2 pan head sheet metal screws. Do not overtighten screws.

Electrical Connection:

2-Wire Operation:

CAUTION DO NOT EXCEED SPECIFIED SUPPLY VOLTAGE RATINGS. PERMANENT DAMAGE NOT COVERED BY WARRANTY WILL RESULT. 2-WIRE UNITS ARE NOT DESIGNED FOR AC VOLTAGE OPERATION.

SPECIFICATIONS

Service: Air and non-combustible, compatible gases.

Wetted Materials: Consult factory.

Accuracy: ±1% for 0.25" (50 Pa), 0.5" (100 Pa), 2" (500 Pa), 5" (1250 Pa), ±2% for 0.1" (25 Pa), 1" (250 Pa) and all bi-directional ranges.

Stability: ±1% F.S./ year.

Temperature Limits: 0 to 150°F (-18 to 66°C).

Pressure Limits: 1 psi (6.89 kPa) maximum, operation; 10 psi (68.9 kPa) burst.

Power Requirements: 2-wire, 10 to 35 VDC; 3-wire, 17 to 36 VDC or isolated 21.6 to 33 VAC.

Output Signals: 2-wire, 4 to 20 mA; 3-wire, 0 to 10 V or 0 to 5 V.

Response Time: Adjustable 0.5 to 15 sec. time constant. Provides a 95% response time of 1.5 to 45 seconds.

Zero & Span Adjustments: Digital push button.

Loop Resistance: Current output: 0-1250 ohm max; Voltage output: min. load resistance 1 k ohmΩ.

Current Consumption: 40 mA max.

Display (optional): 4 digit LCD.

Electrical Connections: 4 to 20 mA units: 2-Wire: European style terminal block for 16 to 26 AWG; 0 to 10 V units: 3-Wire: European style terminal block 16 to 22 AWG.

Electrical Entry: 1/2" NPS thread.

Accessory: A-151 cable gland for 5 to 10 mm diameter cable.

Process Connections: 3/16" (5 mm) ID tubing. Maximum OD 9 mm.

Enclosure Rating: NEMA 4X (IP65).

Mounting Orientation: Diaphragm in vertical position.

Weight: 8.0 oz (230 g).

Agency Approval: CE.

The following standards were used for CE approval:

- CENELEC EN 61000-4-2: 2001
- CENELEC EN 61000-4-3: 2002
- CENELEC EN 61000-4-4: 1995
- CENELEC EN 61000-4-5: 2001
- CENELEC EN 61000-4-6: 2003
- CENELEC EN 61000-4-8: 2001
- CENELEC EN 55011: 2003
- CENELEC EN 61326: 2002
- 89/336/EED EMC Directive

Electrical Connection:

2-Wire Operation, continued:

The connections to the transmitter are made through a two circuit European style terminal block TB1 located at the bottom left of the main PB board. Polarity is indicated by + and - signs on the P.C. board.

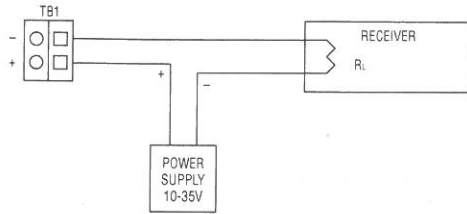

Figure 1

An external power supply delivering 10 to 35 VDC with a minimum current capability of 40 milliamps must be used to power the control loop in which the Magnesense® transmitter is connected. Refer to Fig. 1 for connection of the power supply, transmitter and receiver. The range of appropriate receiver load resistances (R_L) for the power supply voltage available is given by the formula and graph in Fig. 2. Shielded two wire cable is recommended for control loop wiring and the negative side of the loop may be grounded if desired. Note also that the receiver may be connected in either the negative or positive side of the loop, whichever is most convenient. Should polarity of the transmitter or receiver be inadvertently reversed, the loop will not function properly but no damage will be done to the transmitter.

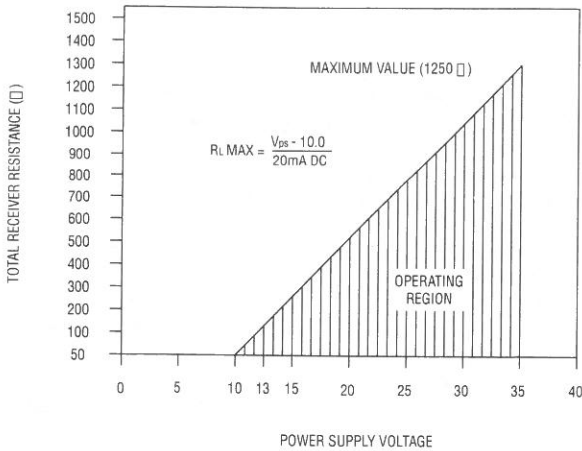

Figure 2

The maximum length of connecting wire between the transmitter and the receiver is a function of wire size and receiver resistance. That portion of the total current loop resistance represented by the resistance of the connecting wires themselves should not exceed 10% of the receiver resistance. For extremely long runs (over 1,000 feet), it is desirable to select receivers with higher resistances in order to keep the size and cost of the connecting leads as low as possible. In installations where the connecting run is no more than 100 feet, connecting lead wire as small as No. 22 Ga. can be used.

3-Wire Operation:

CAUTION DO NOT EXCEED SPECIFIED SUPPLY VOLTAGE RATINGS. PERMANENT DAMAGE NOT COVERED BY WARRANTY WILL RESULT.

The connections to the transmitter are made through a three circuit European style terminal block. Connect the power and signal leads to the corresponding terminals as shown in Fig. 3. When using a DC supply, the positive of the supply should be connected to V+ and the negative connected to Com. Connecting the leads in reverse will not damage the device but it will not operate. The DC supply should be capable of providing 20 mA or more of current per Magnesense® transmitter.

When using an isolated AC supply, either leads of the supply may be connected to Com and V+. The input diode of the device half wave rectifies and filters the applied AC voltage. A small DC current of less than 20 mA is thus drawn through the transformer. The transformer used for the AC supply must be capable of handling this small DC current. Use a UL 1584 Class 2 rated transformer rated between 24 V and 30 VAC, 40 VA or larger, 50/60 Hz. UL 1584 Class 2 rated transformers are limited to 30 VAC maximum under any conditions at nominal line. The AC input voltage to the device is thus limited to a minimum of 21.6 at low line (24 V-10%) and 33 V at high line (30 V+10%).

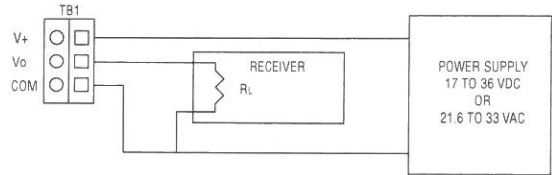

Figure 3

The output of V_o is 0 to 10 VDC or 0 to 5 VDC depending on model. As much as 10 mA may be drawn from V_o without affecting accuracy. This limits the minimum load R_L connected to V_o to 1 KΩ or higher. Remember to keep the wiring resistance between the output and the receiver R_L low compared to value of R_L . While the voltage at the terminals remains unchanged with a 10 mA current flow, resistive losses in the wiring do cause errors in the voltage delivered to R_L . For a 1% accurate gauge, a good rule of thumb would be to keep the resistance of the leads less than 0.1% of the value of R_L . This will keep the error caused by current flow below 0.1%.

To minimize noise in the signal use shielded cable. The common line may also be grounded.

Pressure Connections

Two integral tubing connectors are provided. They are designed to fit 3/16" (5 mm) ID tubing. Connect the high pressure to the High side as shown in Fig. 4. Be sure the pressure ratings of the tubing exceed that of the operating ranges.

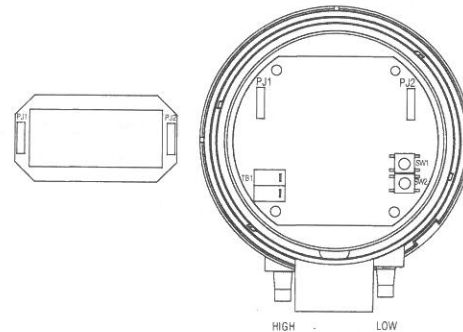

Figure 4

Select Operation Mode and Range:

The operating modes and ranges are controlled by two shorting jumpers on a pair of jumper blocks, PJ3 and PJ5. These two jumper blocks are shown in Fig. 5.

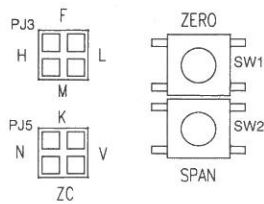

Figure 5: Mode and Range Programming Jumpers and Switches

Jumper block PJ3's primary function is to control when the unit is in the High, Medium or Low range. Each unit has three user selectable operating ranges for what input pressure corresponds to full scale of the analog output. When the left two pins on PJ3 next to the letter "H" are shorted together by the supplied shorting jumper, the device's full scale analog output corresponds to the highest pressure range of the unit. When the shorting jumper shorts the bottom two jumpers next to the letter "M" of PJ3, the full scale analog output corresponds to the middle range of the unit. Similarly the low range is selected by placing the shorting jumper on the pins of PJ3 next to the letter "L". The jumper for PJ3 is factory installed to the high range. If no jumper is installed on PJ3, the device defaults to the "H" range selection.

Jumper block PJ5's primary function is to control the operating mode. There are three operating modes, Normal, zero center and Velocity. The Normal operating mode provides for zero pressure to correspond to 0 V or 4 mA output. This mode is selected by placing the supplied shorting jumper for PJ5 on the pins next to the letter "N". The jumper for PJ5 is factory installed to the Normal Mode on standard units. If no jumper is installed on PJ5, the device defaults to the "N" selection.

On factory ordered bi-directional units, the PJ5 jumper will come from the factory in the ZC or Zero-Center position.

The Zero Center operating mode provides for zero pressure to correspond to 2.5 V, 5 V or 12 mA while the selected full scale range corresponds to 5 V, 10 V or 20 mA current. Negative full scale pressure is required to go to 0 V or 4.0 mA.

The Velocity mode provides the ability for the unit in conjunction with a pitot tube or similar flow sensor with known K factor to give a direct output in air velocity. This mode is selected by placing the supplied shorting jumper for PJ5 on the pins next to the letter "V". The Velocity mode overrides the High, Middle, and Low range setting on PJ3 and forces the unit to the High range setting. If the optional display is present, this mode prompts the display to read in air velocity. The current or voltage output is modified such that full scale output is $4004 \cdot K \cdot \sqrt{\Delta P}$ feet per minute or its metric equivalent in meters per second depending upon which units are selected. The factory programming for the K factor is 1.00 but may be adjusted (see Adjust K Factor). The velocity displayed for the various models can be found in Table 1.

Velocity Displayed		
Model	English	Metric
MS-X2X	K* 2830 fpm	K* 14.4 m/s
MS-X1X	K* 8950 fpm	K* 45.5 m/s

Table 1

SETUP

Set Measurement Units:

Magnesense® transmitters can be easily set to operate in either English or metric units.

The programming jumper is PJ7 and is located in the upper half of the board and under the LCD display if the LCD is present. A representation of this jumper is shown in Fig. 6. English units are selected by placing the provided shorting jumper on the lower two pins of the block next to the label "H2O". Metric units are selected by placing the provided shorting jumper on the upper two pins of the block next to the label "Pa". If no jumper is present English units are selected by default.



Figure 6: Measurement Units Programming Jumper

In addition to the obvious change in the scale of the LCD display, the full scale range and corresponding analog outputs are also affected by the measurement units selection. The analog output goes to full scale output (5 volts, 10 volts or 20 mA depending on model) of the selected range and units. See Table 2. For example on Model MS-X2X, when high range and English units are selected full scale output occurs at 0.5 in w.c. (124.5 Pa). When high range and metric units are selected, analog full scale output is at 100 Pa (0.4015 in w.c.).

FULL SCALE ANALOG OUTPUT STANDARD MODELS

Model		Low	Medium	High
MS-X2X	English	0.1 in w.c.	0.25 in w.c.	0.5 in w.c.
	Metric	25 Pa	50 Pa	100 Pa
MS-X1X	English	1 in w.c.	2 in w.c.	5 in w.c.
	Metric	250 Pa	500 Pa	1250 Pa

Table 2

Zero Center Models

Model		Low	Medium	High
MS-021	English	±0.1 in w.c.	±0.25 in w.c.	±0.5 in w.c.
MS-221	Metric	±25 Pa	±50 Pa	±100 Pa

Install Optional Display:

The A-435 LCD conversion kit allows any non display model to have the LCD added at a later time. The kit contains an LCD display and replacement cover with LCD window. The optional display may be set to read pressure either in inches water column or pascal. The optional display can be also set to display air velocity in feet per minute or meters per second when used with a pitot tube or similar flow sensor with a known K factor.

The optional display for the Magnesense® transmitter is mounted on the main board by connectors PJ1 and PJ2. The display is properly mounted when PJ1 and PJ2 on the display are connected to the corresponding PJ1 and PJ2 on the main board. See Fig. 4. Installing the display upside down causes no harm to the display or the main board. The display just simply reads upside down.

When upgrading a Magnesense® transmitter with an A-435 display kit, it is important to note that it is possible for a device to have been user calibrated to appear properly calibrated at the analog output while in fact, it has been improperly calibrated. This can be done by improperly calibrating the analog output's zero and span and then using the pressure zero and span to compensate for the improperly calibrated analog output. This possibility can be eliminated by checking that the analog output's zero calibration is either 0 V or 4 mA and the analog output's full scale calibration is either 10 V or 20 mA output. See the User Calibration section for details on how to perform these tests.

Label Display (Optional):

The optional LCD display does not contain engineering unit indication. So that the display may be appropriately marked, four adhesive labels have been provided with the units. The unit labels are IN W.C., Pa, fpm, and M/S. Attach the appropriate provided units label above the display window on the cover of the device to indicate to which units the display has been set.

Adjust K Factor:

If the optional display is present, the K factor used in velocity measurements may be adjusted. This is done by activating the K factor adjustment function of the unit. To activate the K factor adjustment function, take the shorting jumper from programming block PJ5 and place it on the upper two terminals next to the letter "K". See Fig. 5. The display will now show the programmed pitot tube K factor. The K factor can be adjusted up and down by using the zero and span buttons as up and down buttons. Once the desired K factor has been set, replace the shorting jumper on PJ5 to its velocity position ("V"). The shorting jumper must not be left in the "K" position for proper operation of the unit. The factory setting for the K factor is 1.0 and it is adjustable from 0.5 to 3.

Adjust Filter Time Constant:

If the optional display is present, the dampening filter time constant of the output may be adjusted from 0.5 to 15 seconds in 1-second increments. In turbulent air, the pressure reading may be unstable. The dampening filter time constant is provided to reduce such noise. The time constant is the actual filter time constant, not averaging time. For an abrupt change in pressure it will take three time constants to reach 95% of the final value.

To activate the filter adjustment function, take the shorting jumper for programming block PJ3 and place it on the upper two terminals next to the letter "F". See Fig. 5. The display will now show the filter time constant. The time constant can be adjusted up and down by using the zero and span buttons as up and down buttons. Once the desired time constant has been set, replace the shorting jumper on PJ3 to its original position. The shorting jumper must not be left in the "F" position for proper operation of the unit. The factory setting for the time constant of the filter is 0.5 seconds.

USER CALIBRATION

The transmitter may be user calibrated. With the two buttons marked "Zero" and "Span" (see Fig. 5) four calibration coefficients may be altered: pressure zero, pressure span can be calibrated with the two buttons marked "zero" and "span" (see Fig. 5). Analog output zero, either 0 V or 4 mA, and analog output full scale, either 5 V, 10 V or 20 mA may be adjusted with two buttons marked "zero" and "span" in conjunction with jumper settings. Pressure and output are calibrated separately to ensure the displayed pressure is correct and the analog output has accurately calibrated end points. These calibration coefficients are stored in nonvolatile memory, which retains its content indefinitely without external power or batteries. Factory calibration may be easily restored.

To calibrate the transmitter you will need three pieces of equipment. First, you will need a calibrated pressure source capable of generating a stable pressure value for the maximum range of the unit under test. You will need a manometer or gage capable of validating the calibration pressure unless that is built into the pressure source. You will also need a voltmeter or milliammeter to calibrate the output. The transmitter is calibrated using the following procedure.

Preparation – Depending upon if it is a 2-wire or 3-wire system, connect the voltmeter or milliammeter and power supply, being careful to observe polarities. The transmitter must be calibrated in a vertical position. Make sure the unit has been returned to its factory default span and zero settings by pressing and holding both the "Zero" and "Span" switches, simultaneously, for about 4 to 5 seconds (doing this can be necessary to erase bad zero and span values that might have been stored by a previous user of the Magnesense® unit).

Calibrating Pressure Zero – Leaving the hose barbs vented, press and hold the "Zero" switch for about 4 to 5 seconds. The zero point should now be set and, if the display is present, the display will read zero. Calibrating pressure should begin with setting the zero first, then the span, since the zero setpoint will affect the span value. Once the "Zero" is set, for uni-directional models, your output reading should be close to 4.0 mA or 0 V. For bi-directional models, 12 mA for current outputs, 2.5 V for 5 V models and 5 volts for 0 to 10 V models.

Span – PJ3 jumper must be in "H" position to calibrate the span and PJ7 jumper must be in the "H2O" position.

Note: If you must calibrate in Pa mode with the PJ7 jumper in the Pa position, you must calibrate the unit to the full scale inches of water column equivalent for proper calibration. For example: 1 in w.c. full scale models the equivalent required is 125 Pa.

Also, the PJ5 jumper should be set to "ZC" on a bidirectional unit and "N" on a unidirectional unit. Connect the pressure source and apply the high range rated pressure. When the pressure has stabilized, press and hold the "Span" switch for about 4 to 5 seconds. The display, if present, will now read the calibration pressure. Span may only be calibrated on the highest range for the unit.

Restoring Factory Calibration Coefficients:

The user calibration does not affect the factory calibration coefficients. The factory defaults are easily restored if the user calibration must be "erased". Simultaneously press both the "Zero" and "Span" buttons and hold them for approximately 4 to 5 seconds. The factory calibration should now be restored.

MAINTENANCE

Annual recalibration is suggested. No lubrication or other periodic servicing is required. Keep exterior and cover clean. Occasionally disconnect pressure lines to vent both sides of gauge to atmosphere and re-zero. Do not use solvent to clean transmitter. Use only plastic compatible cleaners or water. The Series MS is not field serviceable and should be returned if repair is needed (field repair should not be attempted and may void warranty). Be sure to include a brief description of the problem plus any relevant application notes. Contact customer service to receive a return goods authorization number before shipping.