

Series 910

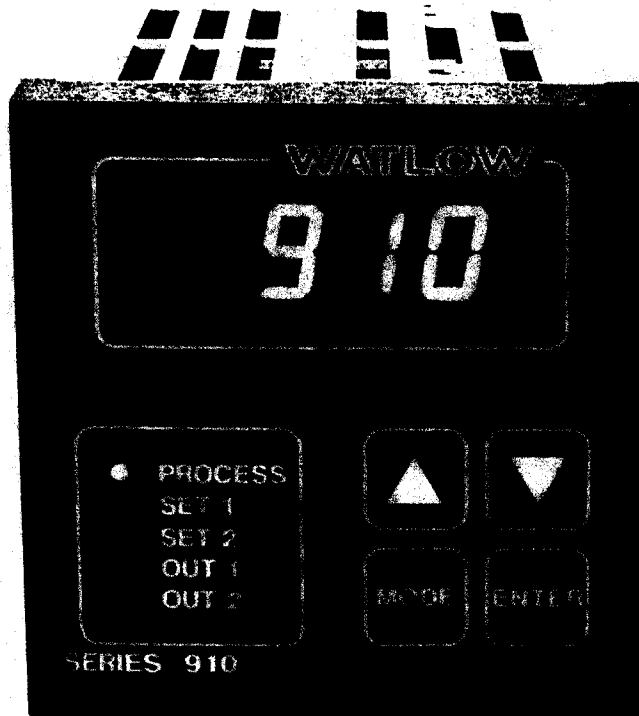

Microprocessor-Based Auto-tuning Control

User's Manual



WATLOW

Watlow Controls, 1241 Buncy Blvd., Winona, MN 55987, Phone: 507/454-5300, Fax: 507/452-4507

W910-MC1C-8827
July, 1988

\$5.00

First...	<i>This manual will make your job easier.</i> Reading it and applying the information is a good way to become familiar with the Series 910. Here's an overview:
Starting Out	Introduction, Chapter 1.
Install/Wire	Installation and wiring, Chapter 2.
Front Panel	Keys and displays, Chapter 3.
Set Up	How to set up, Chapter 4.
Tuning	How to tune, Chapter 5.
Appendix	Specifications Glossary Calibration Warranty

Notes

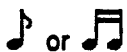

NOTE:
Details of a "Note" appear here, in the narrow box on the outside of each page.

The user's manual contains informational notes to alert you to important details. When you see a note icon, look for an explanation in the margin.

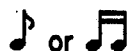

Safety Information

This user's manual also has **boldface** safety information notes to protect both you and your equipment. Please be attentive to them. Here are explanations:



WARNING:
Details of a "Warning" appear here, in the narrow box on the outside of each page.

(The Stop Sign in the wide text column alerts you to a "WARNING," a safety hazard which could affect you and the equipment. A full explanation is in the narrow column on the outside of the page.)



(The Deer Crossing Sign in the wide text column alerts you to a "CAUTION," a safety or functional hazard which could affect your equipment or its performance. A full explanation is in the narrow column on the outside of the page.)



CAUTION:
Details of a "Caution" appear here, in the narrow box on the outside of each page.

Your Feedback

Your comments or suggestions on this manual are welcome, please send them to: Technical Writer, Watlow Winona, Inc., 1241 Bundy Blvd., Winona, MN 55987, or phone 507/454-5300. The Watlow Series 910 User's Manual and Integral software are copyrighted by Watlow Winona, Inc., © 1986, 1987, with all rights reserved.

Page	item	
4	Starting Out With The Watlow Series 910, A Microprocessor-Based Control - Chapter 1	
4	"Read Me First"	
5	Packing List	
5	Steps To Put Your Control To Work	
6	How To Open The 910	
7	How To Set The DIP Switches	
8	Overview Of The 910 Modes (DIP Switch-Based)	
8	Where To Go From Here	
9	How To Install And Wire The Series 910 - Chapter 2	
9	System Planning	
9	Sensor Installation Guidelines	
9	Installation Guidelines For Preventing Noise	
9	The Culprit	
9	An Information Resource	
10	Noise Sources	
10	How To Decrease Noise Sensitivity	
11	How To Eliminate Noise	
12	Microprocessor Are In A Way Like Trout...	
12	Input Power Definitions	
13	The Do's And Don'ts Of Clean Input Power	
14	How To Check For Ground Loops	
14	Noise Suppression Devices Available From Watlow	
15	Line Filtering Configurations For Controls	
16	How To Install The Series 910	
18	How To Wire The Series 910	
21	System Wiring Example	
22	Jumper Selection Before Power Wiring	
23	How To Wire Power For The Series 910	
23	Where To Go From Here	
24	How To Use The Keys And Displays - Chapter 3	
24	Series 910 Keys	
24	Series DIGITAL Display	
25	Series 910 Operating Data	
25	Series 910 Operating Parameters	
25	Where To Go From Here	
26	How To Set Up The Series 910 - Chapter 4	
26	DIP Switches	
27	Installation Parameters	
27	Operating Data And Parameters - DIP Switch #1	
28	Enter Operating Data And Operating Parameters	
29	Set Up Charts With Default Parameters	
30	How To Tune And Operate - Chapter 5	
30	Tuning	
31	The Relationship Between SET 1 And SET 2	
31	Accessing The Default Parameters	
32	How To Deal With Error Codes	
35	Appendix	
35	Model Number Information	
36	Specifications	
38	Calibration	
42	Glossary	
45	Index	
46	Warranty	
47	Returns	
Figures, Tables, Chart		
Page	Item	
4	Series 910 Input And Output Overview	Figure 1
6	How To Open The 910	Figure 2
7	DIP Switch Location	Figure 3
8	Overview Of The 910 Operating Modes	Figure 4
15	Differential Mode Filter Wiring	Figure 5
15	Common Mode Filter Wiring	Figure 6
15	Combination Differential/Common Mode Filter Wiring	Figure 7
16	Series 910 Faceplate Dimensions	Figure 8
17	Series 910 Sideview Dimensions	Figure 9
17	Series 910 Panel Cutout Dimensions	Figure 10
18	Thermocouple Sensor Wiring	Figure 11
18	SS Relay, Output 1 Wiring	Figure 12
19	SS Switch, Output 1 Wiring	Figure 13
19	Mechanical Relay, Output 1 Wiring	Figure 14
19	15A Triac, Output 1 Wiring	Figure 15
19	4-20mA, Output 1 Wiring	Figure 16
20	No Output 2	Figure 17
20	SS Relay, Output 2 Wiring	Figure 18
20	SS Switch, Output 2 Wiring	Figure 19
20	Mechanical Relay, Output 2 Wiring	Figure 20
21	System Wiring Example	Figure 21
22	115/230VAC Selection, Jumper Location And Setting	Figure 22
23	Power Wiring	Figure 23
24	Series 910 Keys	Figure 24
24	Series 910 DIGITAL Display	Figure 25
25	Series 910 Operating Data	Figure 26
25	Series 910 Operating Parameters	Figure 27
38	Reference Compensator-to-Series 910 Connection Diagram	Figure 28
40	Decade Resistance Box-to-Series 910 Connection Diagram	Figure 29
42	Multimeter to Series 910 Connections	Figure 30
7	DIP Switch Selection	Table 1
7	Sensor Type Selection	Table 2
14	Noise Suppression Device Ratings	Table 3
26	DIP Switch Selection (repeat)	Table 4
26	Sensor Type Selection (repeat)	Table 5
41	RTD Calibration Settings	Table 6
29	Series 910 Set Up With Default Parameters	Chart 1

Starting Out With The Watlow Series 910, A Microprocessor-Based Control

Single
Input -
Type
J, K or T
Thermocouple
or RTD

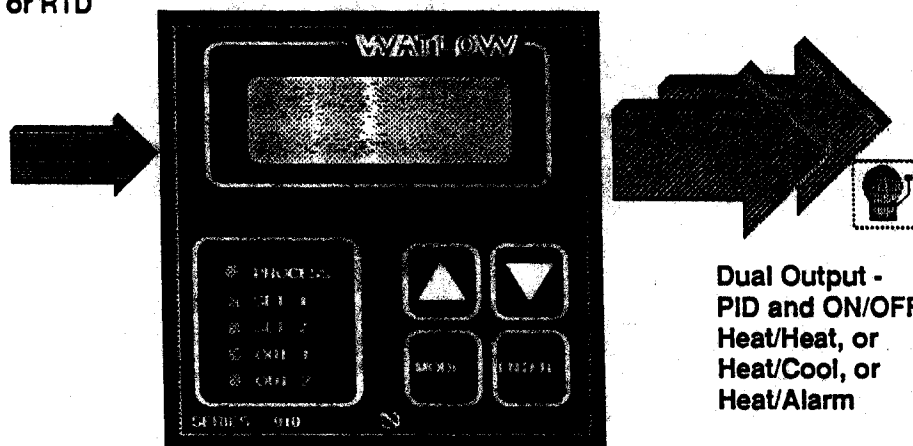

Dual Output -
PID and ON/OFF
Heat/Heat, or
Heat/Cool, or
Heat/Alarm

Figure 1 -
Series 910 Input
and Output
Overview

"Read Me First."

The Watlow Series 910 is a dual output, single input, microprocessor-based, 1/4 DIN-sized temperature control.

It accepts a DIP switch-selectable Type J, K or T thermocouple, or RTD input. The Series 910 offers two output actions; Heat/Heat or Heat/Cool. The second set point can be a deviation value from the primary set point, or an independent set point.

The Series 910 is a PID controller. You may input a complete set of PID parameters, or select automatic tuning for Output 1 from the front panel. This includes proportional band, rate, reset, and cycle time. Output 2 is an ON/OFF output only. It may be used as a temperature related event or alarm output. By setting the Output 1 proportional band to zero, the Series 910 becomes a simple ON/OFF control with a 3 °F or 1.7°C switching differential, 0.3°F or 0.17°C for 0.1° RTD.

Operator-friendly features include automatic, LED indicators to aid in monitoring and set-up, as well as a calibration offset from the front panel. When there's a power outage, the Watlow Series 910 automatically stores all information in a non-volatile memory.

Packing List

When you receive your Series 910, you will have:

- One Series 910 control
- One Series 910 User's Manual
- Two mounting brackets with integral screws

If your control was damaged in shipping or, after thorough check-out, does not function, see the information inside the back cover of this manual.

Steps To Put Your Control To Work

To put your Series 910 to work, we suggest the following steps:

- Read the User's Manual.
- Plan your installation and wiring.
- Cut the panel mounting hole and install the control.
- Wire your Series 910 to the system.
- Start the system and tune the Series 910.
- Make final adjustments to the control parameters and record the data.
- That's all there is to it.

How to Open the 910

Before going further, open the Series 910 and pull the control chassis from its case. Here's how:

The control chassis fastens to the case with a single screw located at the lower front panel. See Figure 2. Turn the screw counterclockwise to loosen it. Two strip connector plugs, in the rear of the control chassis, feed power and signals through the back of the casing to the dual terminal strip. These plugs will let go as you pull.



CAUTION:
The front panel screw turns 90° only. Do not apply excessive force or turn the screw more than 90°.



When removing the Series 910 Control from its case, pull firmly but gently. When returning the control to the case, be sure you **have the top up** to match the plugs with the case. The 910 will not fit in to the case upside down. Always check to see that it is oriented correctly. Press the unit in firmly, then turn the front panel screw clockwise to secure it.

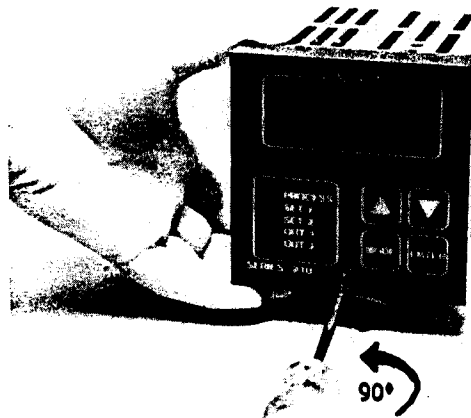
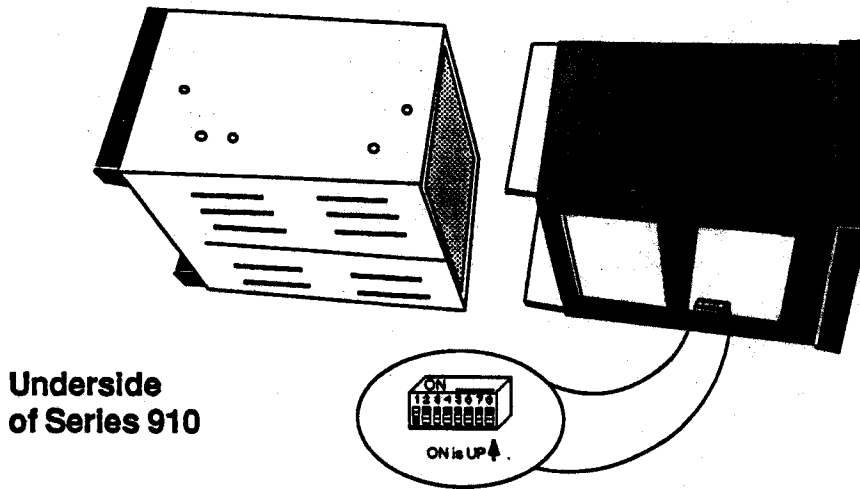

Figure 2 -
How to Open
the 910

How to Set the DIP Switches

DIP Switch information presented here is in overview form. Turn to Chapter 4, "How to Set Up the Series 910," for more complete information.

Figure 3 -
DIP Switch
Location



Underside
of Series 910

The DIP Switches are on the Analog Input Board (A007-1691). They are numbered from 1 through 8. You must open the control to set the switches. When a switch is up, it is in the ON position.

To change the position of a switch, remove the power from the Series 910 and turn the front panel screw 90° counterclockwise. To remove the control chassis, grip the front panel bezel and pull it straight out from the control case. Set the DIP switches, then return the control chassis to the case. Be sure it is oriented correctly. Press firmly, but gently, to seat the chassis. Secure the front panel screw and re-apply power.

Table 1 -
DIP Switch
Selection

DIP Sw#	Function		Normal Operation
	OFF	ON	
1	Display Operating Data Only	Set All Data and Parameters	ON
2	Select Input Type: See Sensor Table		Choose
3	Select Input Type: See Sensor Table		Choose
4	SET 2 as Process Set Point	SET 2 as Deviation Set Point	Choose
5	Fahrenheit (°) Displayed	Celcius (°) Displayed	Choose
6	Heat/Heat Output Action	Heat/Cool Output Action	Choose
7	Normal Operation	Install Default Values	OFF
8	High or Low Deviation 🎵	Deviation Band 🎵	Choose

🎵 NOTE:
DIP switch #6 must be OFF, #4 must be ON.

🎵 NOTE:
Position of DIP switch #6 determines high deviation or low deviation. DIP switch #4 must be ON.

Input Type	DIP #2	DIP #3	Range
J /c	OFF	OFF	32 to 1382°F or 0 to 750°C
K /c	ON	OFF	-328 to 2282°F or -200 to 1250°C
T /c	OFF	ON	-328 to 662°F or -200 to 350°C
RTD 1°	ON	ON	-328 to 1112°F or -200 to 600°C
RTD 0.1°	ON	ON	-94.0 to 392.0°F or -70.0 to 200.0°C

Table 2 -
Sensor Type
Selection

Overview of the 910 Modes (DIP Switch-Based)

The figure below shows how the 910 modes work by DIP switch. Dotted boxes represent special operations.

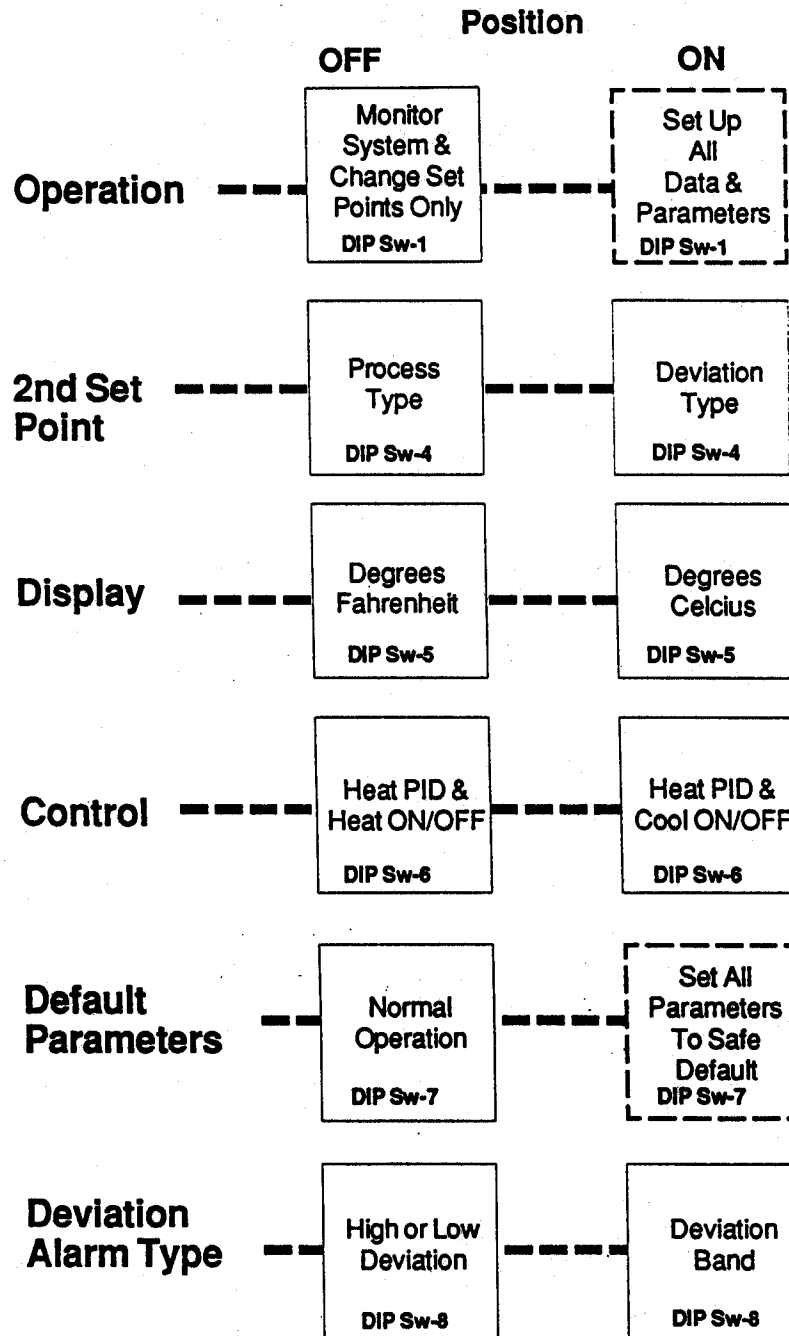

Figure 4 - Overview of the 910 Operating Modes

Where To Go From Here

If your Series 910 is already installed and wired, go directly to "How to Use the Keys and Displays", Chapter 3. If not, turn the page to Chapter 2, "How to Install and Wire the Series 910", and proceed from there.

Chapter 2

How to Install and Wire the Series 910

System Planning

This chapter will tell you how to install the Series 910. All mounting and wiring information is right here. Because Watlow controls are thoroughly tested, and "burned in" before leaving the factory, the Series 910 is ready to install when you receive it.

But before you begin working, read through this chapter to gain an understanding of the entire installation. Consider sensor installation carefully. You'll need to look at the noise reduction guidelines before making your panel cutout.

Sensor Installation Guidelines

We suggest that you mount the sensor at a location in your process or system where it reads an average temperature. Put the sensor as near as possible to the material or space that you want to control. Air flow past this sensor should be moderate. The sensor should be thermally insulated from the sensor mounting.

Installation Guidelines For Preventing Noise

For improved electrical noise immunity, install the Series 910 as far away as possible from motors, relays, and other similar noise generators.

Do not run low power (sensor input) lines in the same bundle as AC power lines. Grouping these lines in the same bundle can create electrical noise interference which may result in error codes in the Series 910.

The Culprit

Most noise problems stem from wiring practices. They're the major means of coupling noise from its sources to the control circuit. The following information will tell you how to eliminate or decrease noise.

An Information Resource



An outstanding resource for information for wiring guidelines is the IEEE Standard No. 518-1982 and is available from IEEE, Inc. 345 East 47th Street, New York, NY 10017.

Noise Sources

- Switches and relay contacts operating inductive loads such as motors, coils, solenoids, and relays, etc.
- Thyristors or other semiconductor devices which are not zero crossover-fired (randomly-fired or phase angle-fired devices).
- All welding machinery.
- Heavy current carrying conductors.
- Fluorescent and neon lights.

How To Decrease Noise Sensitivity

- Physical separation and wire routing must be given careful consideration in planning the layout of the system. For example, A.C. power supply lines should be bundled together and physically kept separate from input signal lines (very low power level). Keep all switched output signal lines (high power level) separate from current control loop signals (low power level).
- Another important practice is to look at the system layout and identify electrical noise sources such as solenoids, relay contacts, motors, etc., and where they are physically located. Then route the wire bundles and cables as far away as possible from these noise sources.
- Shielded cables should be used for all low power signal lines to protect from magnetic and electrostatic coupling of noise. Some simple pointers are:
 - ◊ Whenever possible, low level signal line should be run unbroken from signal source to the control circuit.
 - ◊ Connect the shield to the control circuit common end only. Never leave the shield unconnected at both ends. Never connect both shield ends to a common.
 - ◊ If the shield is broken at some termination point and then continued on, the shield must be connected to maintain shield continuity.
 - ◊ If the shield is used as a signal return, no electrostatic shielding should be assumed. If this must be done, use a triaxial cable (electrostatically shielded coaxial cable).
- Twisted pair wire should be used any time control circuit signals must travel over two feet or when they are bundled in parallel with other wires.
- The size or gauge of wire should be selected by calculating the maximum circuit current and choosing the gauge meeting that requirement. Using greatly larger wire sizes than required generally will increase the likelihood of electrostatic (capacitance) coupling of noise.
- Ground loops must be eliminated in the entire control system. There are obvious loops which can be spotted by studying the "as-built" wiring diagram. There are also the not-so-obvious ground loops that result from the technique of connecting internal circuit commons in the manufacturer's equipment. An example of this would be if a control circuit is designed to work with a grounded sensor input.
- Do not daisy chain A.C. power (or return) lines, or output signal (or return) lines to multiple control circuits. Use a direct line from the power source to each input requiring A.C. power. Avoid paralleling L1 (power lead) and L2 (return lead) to load power solenoids, contactors, and control circuits. If L1 (power lead) is used to switch a load, L2 (return lead) will have the same switched signal and could couple unwanted noise into a control circuit.

- Grounding the chassis of each piece of equipment in the system is very important. The simple practice of connecting each individual chassis to the overall equipment chassis immediately adjacent to that piece, and then tie all the major chassis ground terminals together with one lead (usually green wire) to ground at one single point will work best. 
- Do not confuse chassis grounds (safety ground) with control circuit commons or with A.C. supply lines L2 (return or neutral line). Each return system wiring must be kept separate. Be absolutely sure chassis ground (safety) is never used as a conductor to return circuit current. 

 **NOTE:**
See chassis ground "CAUTION" listed with Figures 20 and 22.

How To Eliminate Noise

- Use "snubbers" ("QUENCHARC™") to filter out noise generated by devices such as relays, relay contacts, solenoids, motors, etc. A snubber is a simple filter device using a .1µf, 600 volt, non-polarized capacitor in series with a 100 ohm, 1/2 watt resistor. The device can be used on A.C. or D.C. circuits to effectively dampen noise at its source.
- The general purpose Watlow snubber is 0804-0147-0000. For other "QUENCHARC" sizes contact:
PAKTRON
P.O. Box 5439
Lynchburg, VA 24502
Phone: 804/239-6941
- A Metal Oxide Varistor (MOV) can be used to limit voltage "spikes" that occur on the A.C. supply lines as a result of lightning strikes, switching large motors, etc. The MOV is available in several varieties and for 115 or 230 volt lines. The device dissipates the voltage "spikes" to ground and in doing so repeatedly, deteriorates its ability to function. MOVs have a limited life.
- Watlow stocks several MOVs. See Table 3 on Page 14.
- "Islatrols" and other similar power line filters are designed to carry the power for the control circuit and at the same time "buffer" the control circuit from A.C. line noise. Devices like the Islatrol use media (electromagnetic filtering) other than electric circuits to filter out the electrical noise. Take care in matching the power capabilities of the filter with the power demands of the circuit.
- Islatrols are available from:
Control Concepts Corporation
328 Water Street
P.O. Box 1380
Binghamton, NY 13902-1380
Phone: 607/724-2484

#1-105 (5A, 115VAC)
#1-115 (15A, 115VAC)
#1-202 (2.5A, 230VAC)
#1-207 (7.5A, 230VAC)
- The ultimate protection is an "uninterruptable" power supply. This device "senses" the A.C. power line; when the line fluctuates, a battery-powered 60Hz inverted circuit takes over, supplying power within one-half to one cycle of the A.C. line. Very expensive.

Microprocessors are in a way like trout...

They require a clean environment to be successful and to prosper. A clean environment means on one level an environment that is free of excessive dust, moisture and other airborne pollutants. But primarily it means a "clean" source of input power from which to base all its operations. What is "clean power?"

Clean power is simply a steady, noise-free line voltage source that meets the rating specifications of the hardware using it. Without clean power to the integrated circuitry, any microprocessor chip is doomed to failure.

Just as the water you get from a tap nowadays may not be acceptable to drink in some locales, so the line voltage coming into your facility may not be acceptable for your microprocessor devices. You may have to filter or "clean" the water or the power. In industrial environments, the potential for pollutants increases, especially electrical noise due to high level power consumption occurring in one place.

The recommendations we are providing for you are ways to achieve a minimum level of clean input power protection. In almost all cases these guidelines will remove the potential for input power problems. If you've applied these measures and still do not get results, please feel free to call us at the factory. We are here to see that our control products work well and do the job they were designed to do.

Input Power Definitions

Ground Loop - A condition created when two or more paths for electricity are created in a ground line, or when one or more paths are created in a shield.

Earth Ground - The starting point for safety and computer grounds. It is usually a copper rod driven into the earth.

Safety Ground - A ground line run along with electrical power wiring to protect personnel.

Computer Ground - A ground line for the ground connections to computers or microprocessor-based systems. This line is isolated from safety ground.

Common Mode Line Filter - A device to filter noise signals present on both power lines with respect to ground.

Differential Mode Line Filter - A device to filter noise signals present between the two power lines themselves.

The Do's and Don'ts of Clean Input Power

Do keep line filters as close to the control as possible to minimize the area for interference pick up.

Do use twisted pair wire and possibly shielded wire from line filters to the control keep the line "clean."

Do keep low power control wires physically separated as far as possible from line voltage wires. Also keep all controller wiring separate from other nearby wiring. Physical separation is extremely effective. A 12 inch minimum separation is usually effective.

Do use common mode, differential mode or a combination of the two filters wherever power may have electrical interferences.

Do cross other wiring at 90° angles whenever crossing lines is unavoidable.

Do have a computer ground line that is separate from all other ground lines. This computer ground line should ideally terminate at the ground rod where the electrical service is grounded.

Don't connect computer ground to safety ground or any other ground points in the electrical system, except at the ground rod.

Don't mount relays or switching devices close to a microprocessor control.

Don't run wires carrying line voltage with signal wires (sensor, communications or other low power lines) going to the control.

Don't use conduit for computer ground.

Don't have phase angle-fired devices in the same electrical enclosure or on the same power line with the control.

Don't connect ground to the control case if the control is mounted in grounded enclosure (prevent ground loops.)

Don't fasten common mode line filters or filters with metal cases to metal that is at ground potential. This prevents ground loops and maintains filter effectiveness.

How To Check For Ground Loops

To check for ground loops, disconnect the ground wire at the ground termination. Measure the resistance from the wire to the point where it was connected. The ohmmeter should read a high ohm value. If you have a low ohm value across this gap, that means there is at least one ground loop present in your system.

Or check for continuity; your reading should be "open". If you do find continuity, you must now begin looking for the ground loops. Begin disconnecting grounds in the system one at a time, checking for continuity after each disconnection. When continuity reads "open" you have eliminated the ground loop(s). Also as you reconnect grounds, keep making the continuity test. It is possible to reconnect a ground loop.

Noise Suppression Devices Available From Watlow

Watlow Winona stocks a few key noise suppression parts. You may order these by calling your local Watlow distributor.

**Table 3 -
Noise
Suppression
Device Ratings**

Item	Electrical Ratings	Part Number
Common Mode Line Filter	250V, 3 Amp	0804-0196-0000
Differential Mode Line Filter	125V, 1 Amp	A001-0108-0000
Metal Oxide Varistor	150V, 20 Joule	0802-0273-0000
MOV	130V, 30 Joule	0802-0304-0000
MOV	275V, 15 Joule	0802-0266-0000
MOV	275V, 100 Joule	0802-0405-0000

Line Filtering Configurations For Controls

These three diagrams show you filter configurations for removing input power noise. Choose the one best suited for your system if you are unsure which one to use, see Figure 7. For very dirty or critical application - use micro-computer-regulated power supply or Uninterruptable Power Supply (U.P.S.)

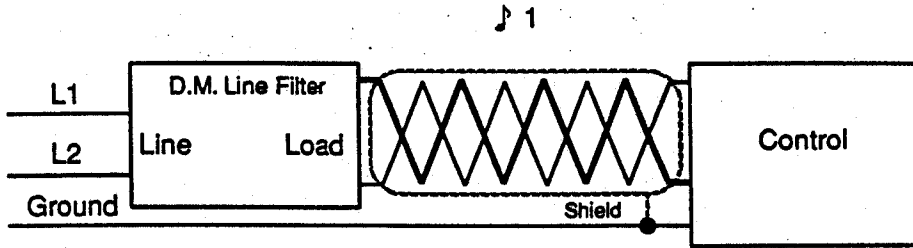

Figure 5 - Differential Mode Filter Wiring



NOTE: Keep filters 12 inches or less from the control. Minimize the line distance where noise can be re-introduced to control.

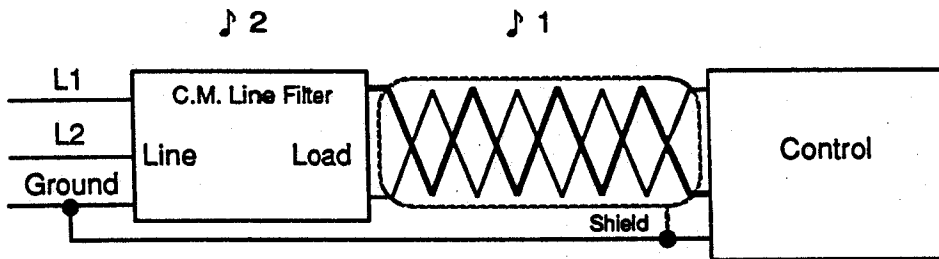

Figure 6 - Common Mode Filter Wiring



NOTE: To prevent ground loops do not fasten common mode line filters or filters with metal cases to metal that is at ground potential. Doing so will reduce filter effectiveness.

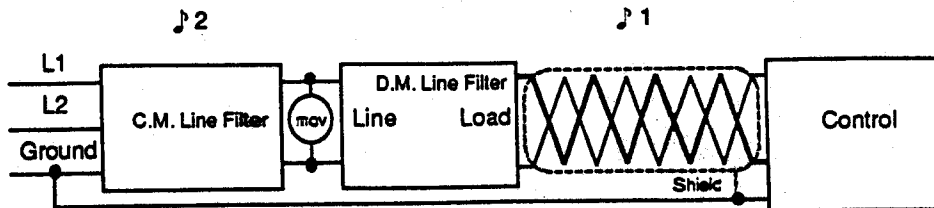
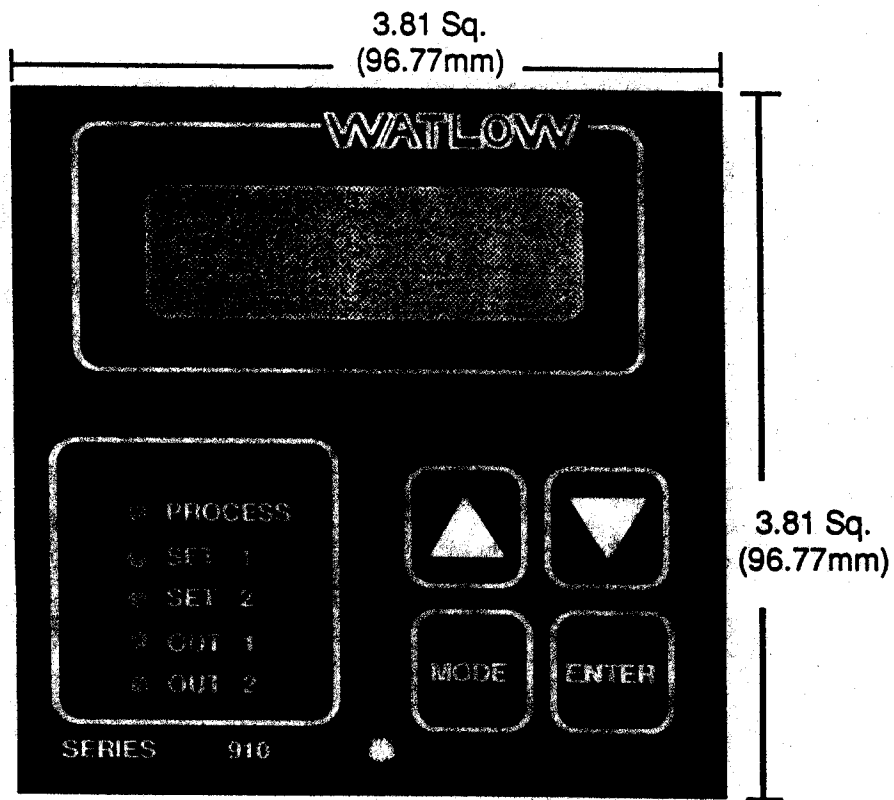

Figure 7 - Combination Differential/Common Mode Filter Wiring

How to Install the Series 910

Figures 8, 9 and 10 provide the Series 910's dimensions. Do not, however, make your panel cutout until you are sure that you are placing the control in the best location. Read the noise guidelines at the beginning of this chapter before installing and wiring the Series 910.



**Figure 8-
Series 910
Faceplate
Dimensions**

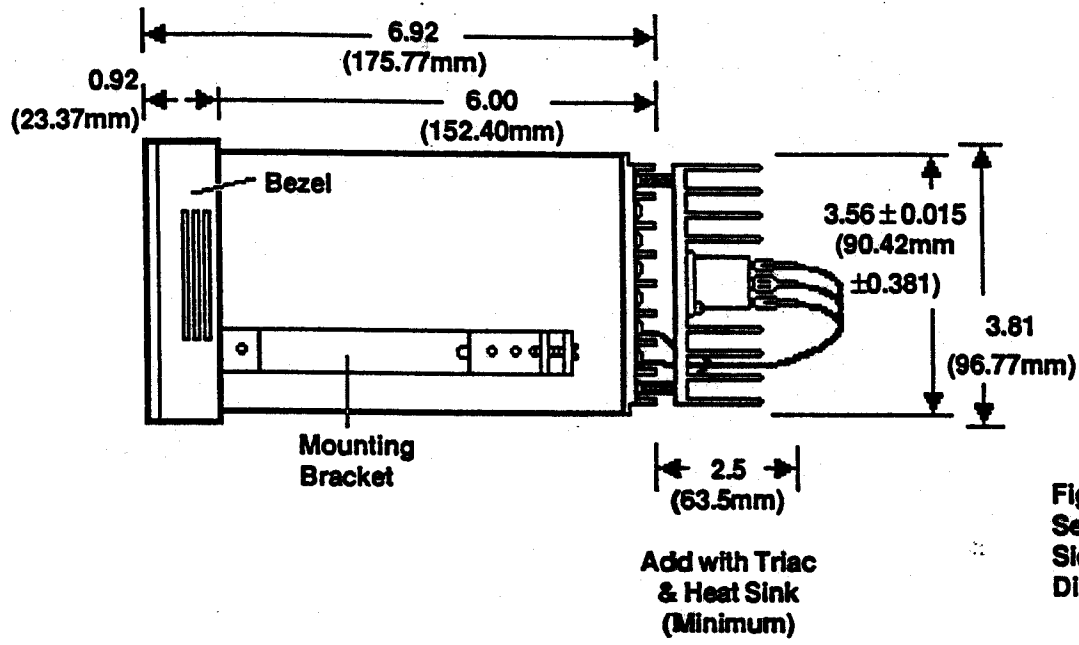

Figure 9 -
Series 910
Sideview
Dimensions

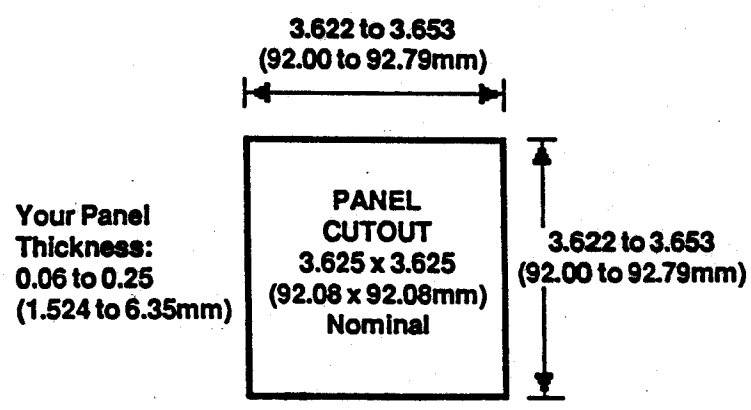

Figure 10 -
Series 910
Panel Cutout
Dimensions

How to Wire the Series 910

The Series 910 wiring is illustrated by model number option. Check the unit sticker on the control and compare your model number to those shown here and also the model number breakdown in the back of this manual.

Series 910 internal circuits appear "inside" the line drawing of the 910, while connections and terminal designations appear "outside" the line drawing. The final wiring figure is a typical system example.

All wiring and fusing should conform to the National Electric Code and to any locally applicable codes as well.

STOP **WARNING:**
 Sensor terminals for thermocouple unit are labeled TC- and TC+. RTD terminals are labeled S1, S2, & S3. **APPLY ONE INPUT ONLY.**

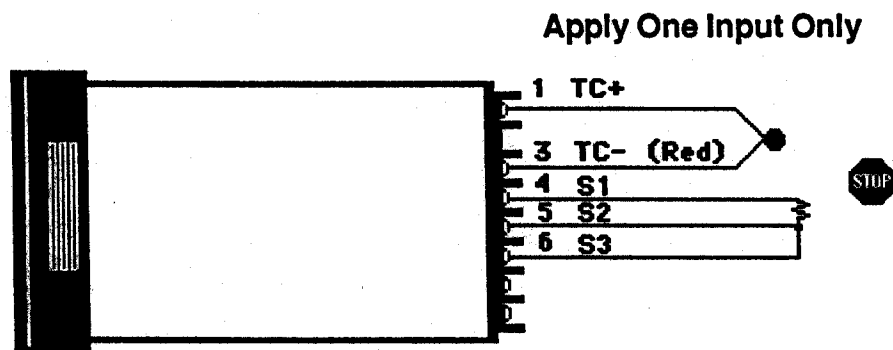
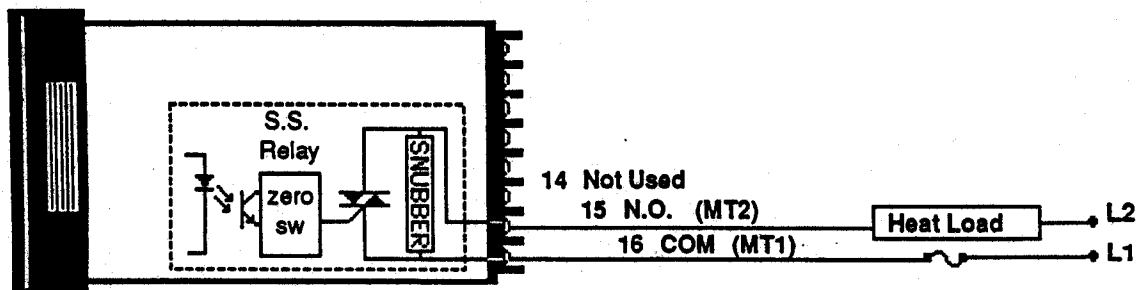

Figure 11 - Thermocouple and RTD Sensor Wiring

910C-**xx**x0-000x



910C-x**B**x0-000x

Figure 12 - SS Relay, Output 1 Wiring

Wire Output 1

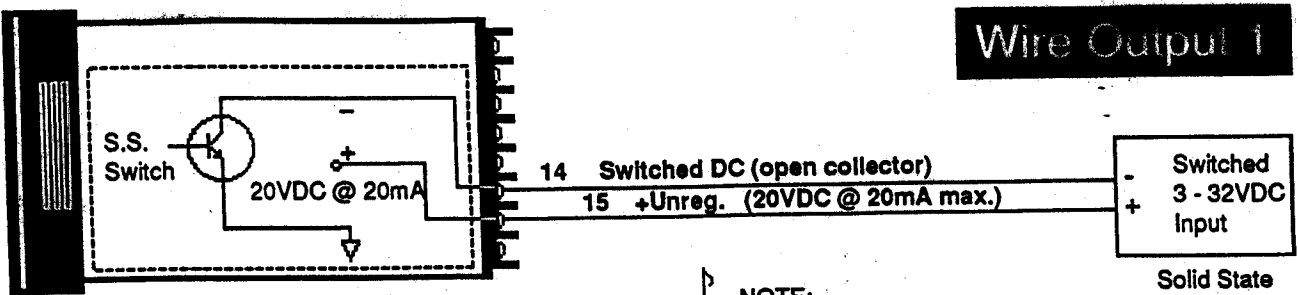

910C-xC-x0-000x

NOTE:
COM used only with external power supply, in such case #15 is not used.

Solid State Contactor requiring 3 to 32VDC input

Figure 13 - SS Switch, Output 1 Wiring

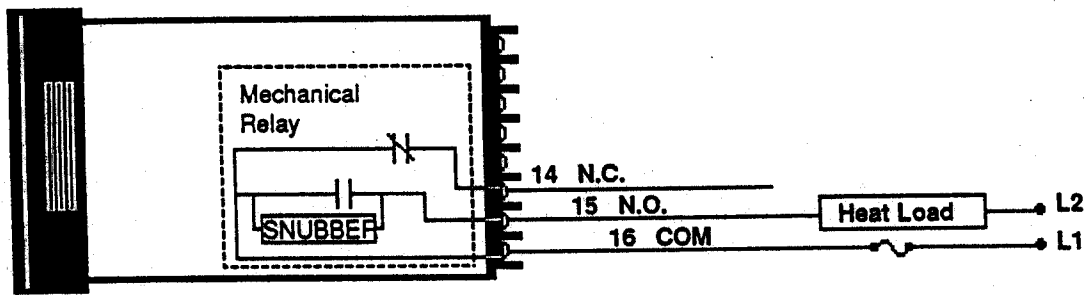

910C-xD-x0-000x

Figure 14 - Mechanical Relay, Output 1 Wiring

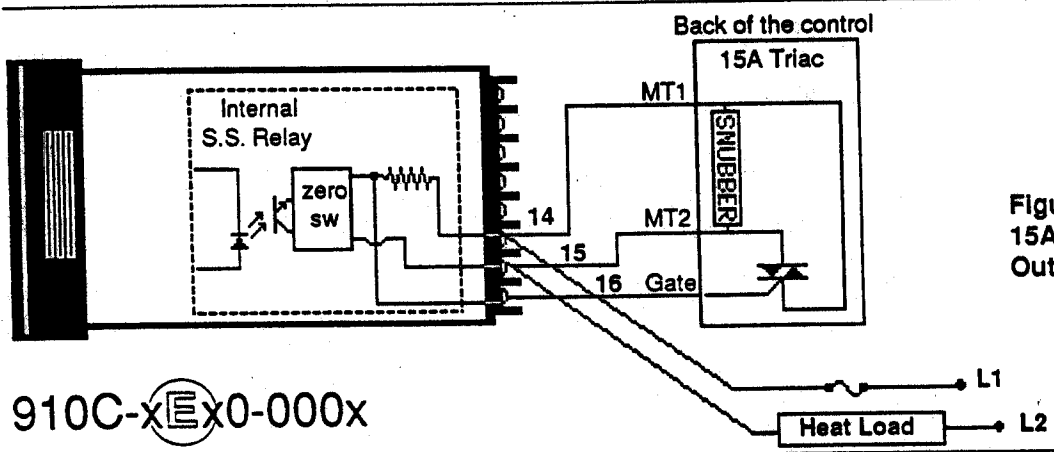

910C-xE-x0-000x

Figure 15 - 15A Triac, Output 1 Wiring

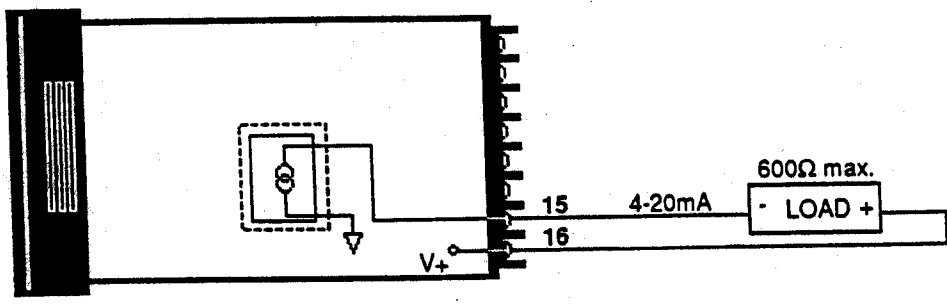

910C-xF-x0-000x

Figure 16 - 4-20mA, Output 1 Wiring

Wire Output 2

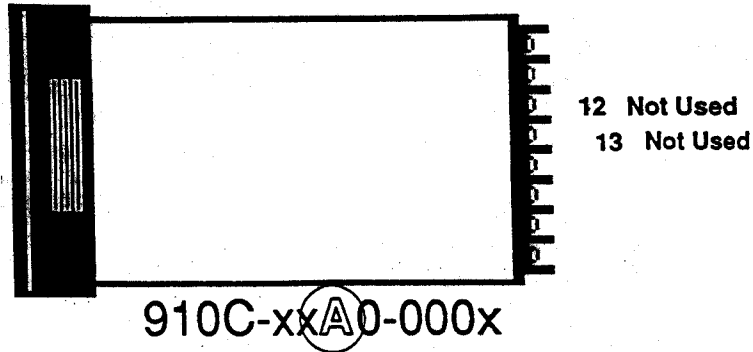

Figure 17 -
No Output 2

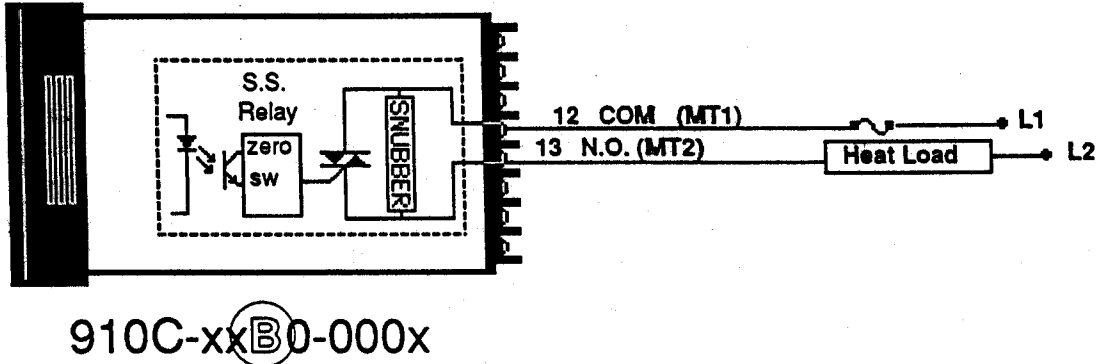

Figure 18 -
SS Relay,
Output 2 Wiring

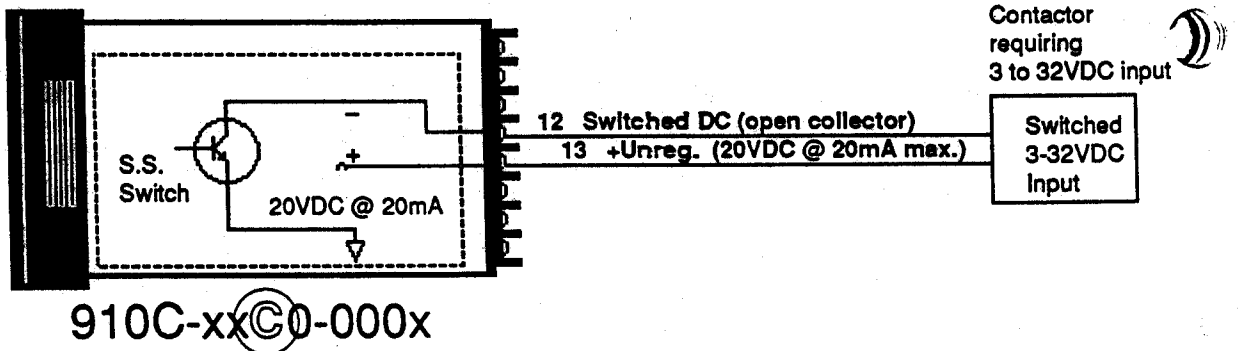

Figure 19 -
SS Switch,
Output 2 Wiring

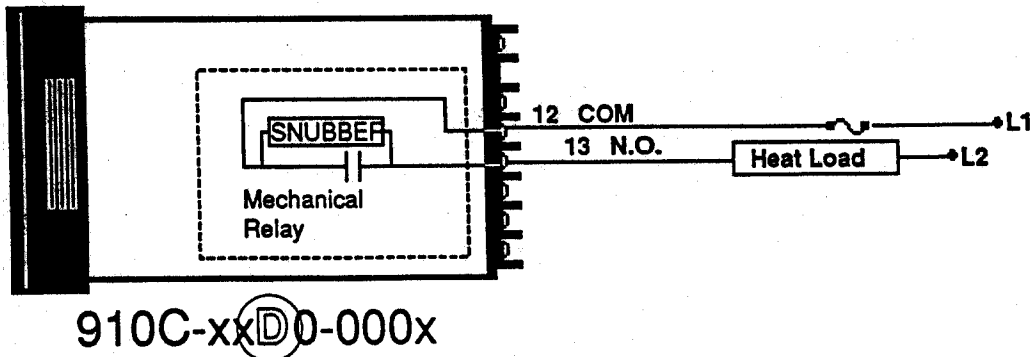

Figure 20 -
Mechanical Relay,
Output 2 Wiring

System Wiring Example

This example shows a typical Series 910 wiring scheme. It represents only one of many output configurations.



CAUTION:
Do not jumper load power from the control power terminals. Doing so will cause your control to be more susceptible to electrical interference from load switching. See Noise Guidelines at the beginning of this chapter.

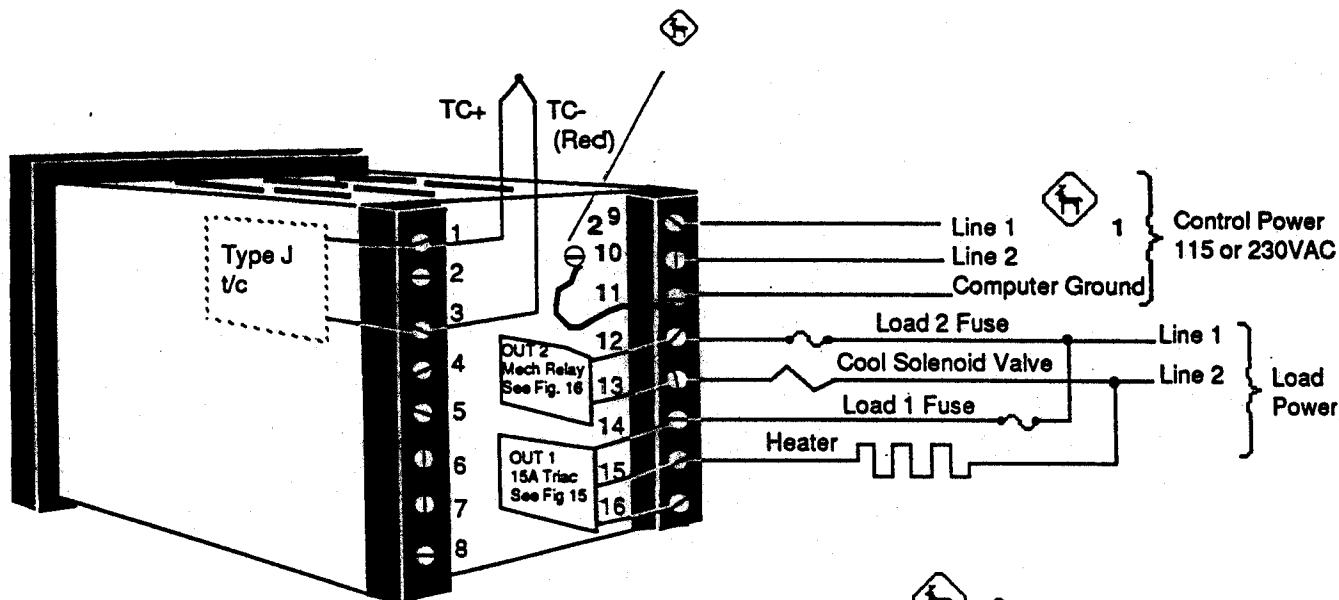

CAUTION:

(chassis) ground. Remove the short green ground jumper on the back of the 910 (Terminal 11) if your control is mounted in a metal panel connected to safety (chassis) ground. Removing the jumper will prevent ground



Leave the short green ground jumper in place if the Series 910 case is not connected to safety

Figure 21 - System Wiring Example

Jumper Selection Before Power Wiring



WARNING:
Placing AC power selection jumpers on more than one set of pins in the 230VAC mode, and then applying 230VAC to the system, will damage your control and could injure personnel.

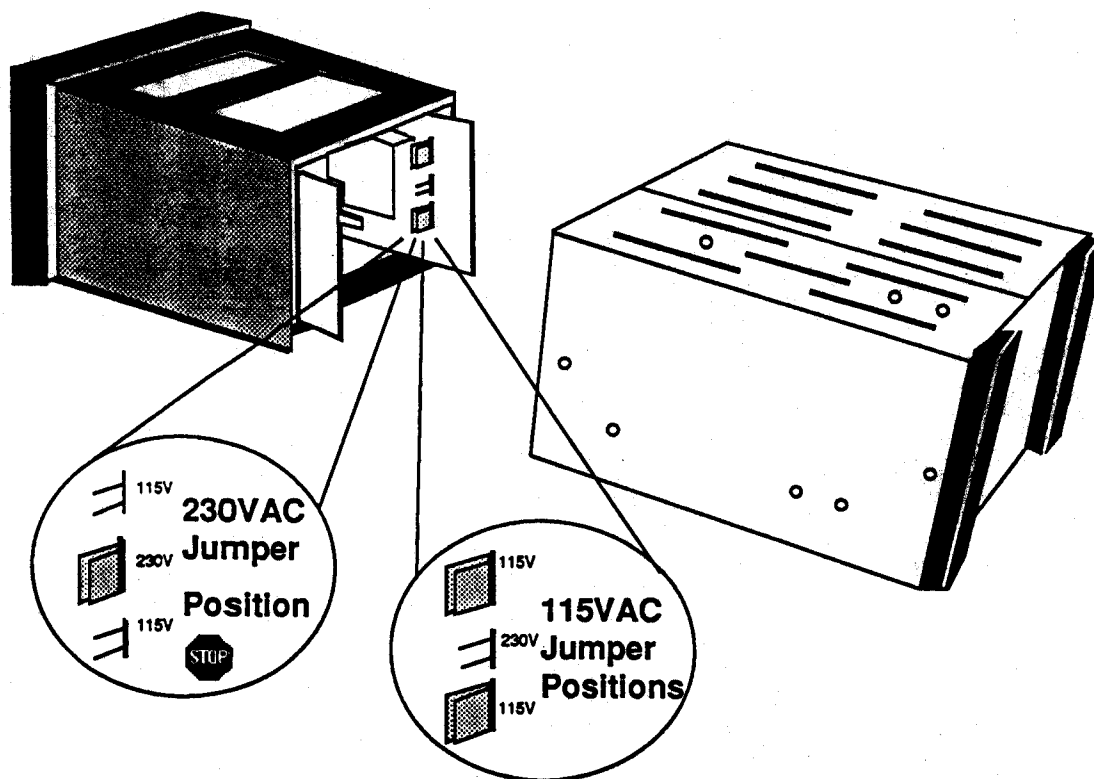

**Figure 22 -
115/230VAC
Selection, Jumper
Location and
Setting**

How to Wire Power for the Series 910

Once you have the input and outputs wired, then add the power wiring.

Check to be certain you have correctly placed the 115/230VAC power jumpers.



CAUTION:
Wiring and fusing should conform to the National Electric Code and all locally applicable codes also.



CAUTION:
Do not jumper load power from the control power terminals. Doing so will cause your control to be more susceptible to electrical interference from load switching. See Noise Guidelines at the beginning of this chapter.

Figure 23 - Power Wiring



CAUTION:
Leave the short green ground jumper in place if the Series 910 case is not connected to safety (chassis) ground. If your 910 is mounted in a metal panel connected to safety (chassis) ground, then remove the short green ground jumper on back of the 910 (Terminal 11) to prevent ground



WARNING:
To avoid electric shock, make all connections on the terminal strips on the back of this control before applying power to the unit.

Install and Wire, Chapter

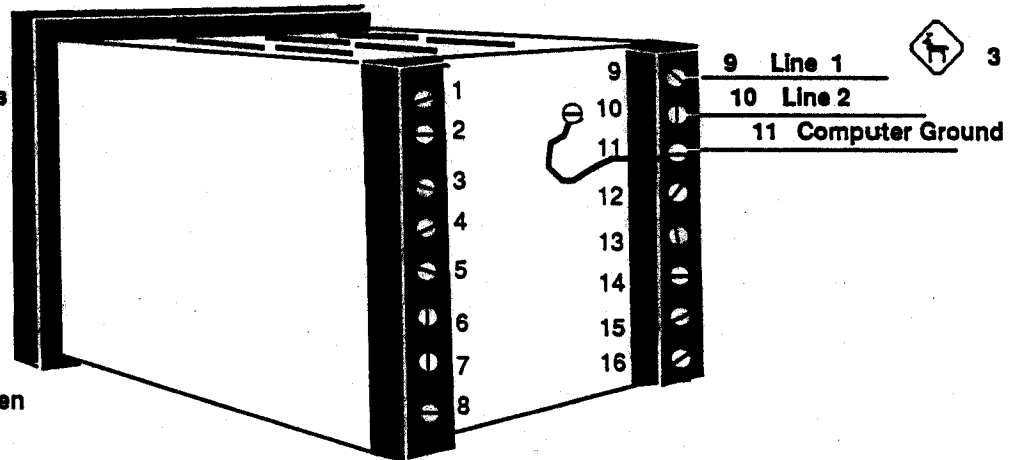

Where to Go From Here

As soon as you have your control correctly wired, you may apply power to the system and begin entering parameter values. Turn to the next chapter to learn how to set up the Series 910.

How to Use the Keys and Displays

Use the following figures to learn the nature and function of the Series 910's keys and displays.

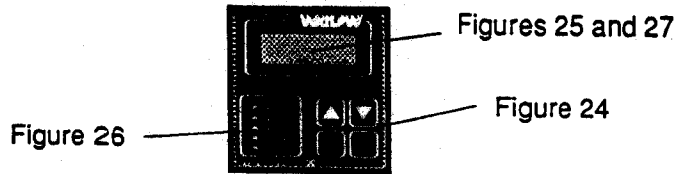

Series 910 Keys

UP Key

Increases the value in the DIGITAL display. A light touch increases the value by one. Holding the key down increases the display value at a rapid rate.

DOWN Key Decreases the value in the DIGITAL display. A light touch decreases the value by one. Holding the key down decreases the displayed value at a rapid rate.

90° Front Panel Locking Screw

Secures the control chassis in its case with a 1/4 turn clockwise or releases the chassis with a 1/4 turn counter-

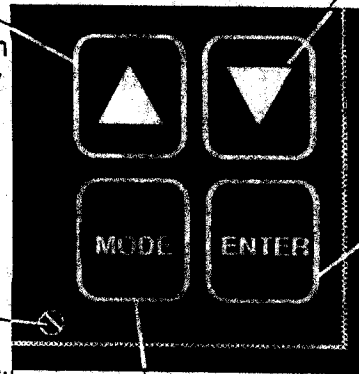

MODE Key

Steps the processor through the Operating Data and Parameter prompts. Sequence varies with the DIP switches.

ENTER Key

Enters data selected by the UP/DOWN keys into the microprocessor. Selected data flashes in the DIGITAL display until you press ENTER. Data is not valid until you press the ENTER key.

Figure 24 - Series 910 Keys

Series DIGITAL Display

DIGITAL Display

Red, 1/2" high LED, seven segment, four digit display indicating either PROCESS actual tempera-

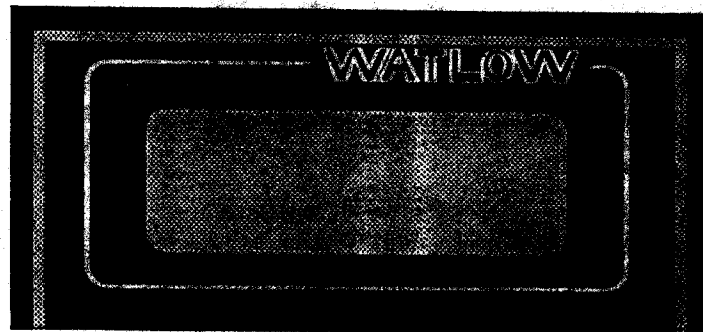

ture, set points (SET 1, SET 2), the operating parameters or error codes.

Figure 25 - Series 910 DIGITAL Display

Series 910 Operating Data

These red, circular LED indicators (in the lower left quadrant of the Series 910 faceplate) appear one at a time with presses to the MODE key when DIP Switch #1 is in the ON position. This "Operating Data and Parameters" information box tells exactly what the DIGITAL display is showing. There is also another set of related indicators which also appears in the box (see below).

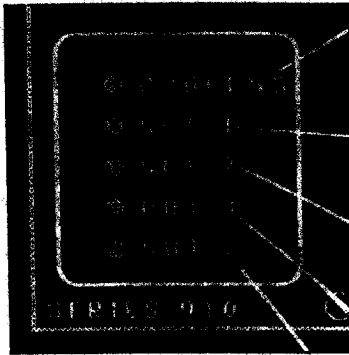

PROCESS Actual Temperature. When the small circular LED is ON, the DIGITAL Display is reading the actual temperature

SET 1, the primary set point. When the small circular LED is ON, the DIGITAL Display is reading SET1.

SET 2, the secondary set point. When the small circular LED is ON, the DIGITAL Display is reading SET 2.

OUT 1. When this circular LED is ON, Output 1 is energized.

OUT 2. When this circular LED is ON, Output

Figure 26 -
Series 910
Operating Data

Series 910 Operating Parameters

When DIP Switch #1 is ON, a set of prompts will appear in the digital display. These are the "set up", or "Operating Parameters." They indicate which PID parameter or calibration offset is showing in the DIGITAL display.

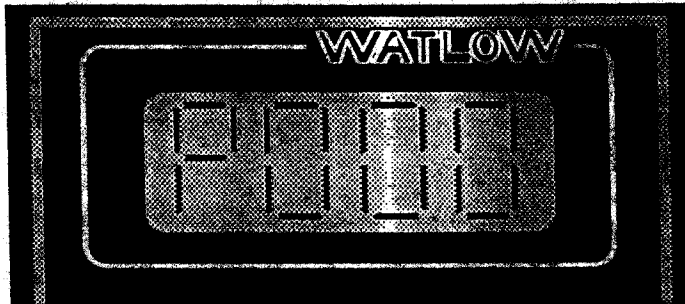

Figure 27 -
Series 910
Operating
Parameters

P Proportional Band value is showing in the DIGITAL display when this prompt appears. You can now set the PROPORTIONAL BANDWIDTH for Output 1.

r Reset value is showing in the DIGITAL display when this prompt appears. You can now enter RESET for Output 1.

d Rate value is showing in the DIGITAL display when this prompt appears. You can now adjust the RATE function for Output 1.

c Cycle Time value is showing in the DIGITAL display when this prompt appears. You can now enter the CYCLE TIME for Output 1.

o Calibration Offset value is showing in the DIGITAL display when this prompt appears. You can now enter a calibration offset value from -10 to 10°C or °F. The Calibration Offset adds or subtracts degrees from the input signal.

A Auto-tune response is showing in the DIGITAL display. You can now initiate an auto-tune by entering a value from 1 to 3.

Where To Go From Here

Now that you know how to read the keys and displays, turn to the next chapter to begin entering data and setting up your control.
Keys and Displays, Chapter 3

How to Set Up the Series 910



Setting up the Series 910 is a simple process involving first setting the "Installation Parameters" by DIP switches, and then entering "Operating Data" and "Operating Parameters" with the Series 910's front panel keys.

The DIP Switches themselves determine most of the 910's "personality," or Installation Parameters. The first switch, in fact, must be ON to select Operating Data (set points) and the Operating Parameters (PID parameters, cycle time and calibration offset). Even though you've already seen the DIP switch table in Chapter 1, we repeat it here for your convenience.

DIP Switches

Recall that you must disconnect power and open the control in order to change the position of a DIP switch. Location and procedure are on p. 7.

Table 4 -
DIP Switch
Selection

DIP Sw#	Function		Normal Operation
	OFF	ON	
1	Display Operating Data Only	Set All Data and Parameters	ON
2	Select Input Type: See Sensor Table		Choose
3	Select Input Type: See Sensor Table		Choose
4	SET 2 as Process Set Point	SET 2 as Deviation Set Point	Choose
5	Fahrenheit °s Displayed	Celcius °s Displayed	Choose
6	Heat/Heat Output Action	Heat/Cool Output Action	Choose
7	Normal Operation	Install Default Values	OFF
8	High or Low Deviation 	Deviation Band 	Choose

 **NOTE:**
DIP switch #6 must be OFF, #4 must be ON.

 **NOTE:**
Position of DIP switch #6 determines high deviation or low deviation. DIP switch #4 must be ON.

Table 5 -
Sensor Type
Selection

Input Type	DIP #2	DIP #3	Range
J t/c	OFF	OFF	32 to 1382°F or 0 to 750°C
K t/c	ON	OFF	-328 to 2282°F or -200 to 1250°C
T t/c	OFF	ON	-328 to 662°F or -200 to 350°C
RTD 1°	ON	ON	-328 to 1112°F or -200 to 600 °C
RTD 0.1°	ON	ON	-94.0 to 392.0°F or -70.0 to 200.0°C

Installation Parameters

The Series 910 has four Installation Parameters that are set by DIP switch.

**Switch 2 &
Switch 3:**

Select Input
Thermocouple Type J, K, or T or RTD.

Switch 4:

Selects Secondary Set Point (SET 2) Type
Process set point or Deviation set point.
As a process set point, SET 2 will control OUT 2 independently of SET 1. As a deviation set point, SET 2 will control OUT 2 always at a fixed relative degree distance from SET 1.

Switch 5:

Selects Units of Measure
Fahrenheit or Celcius.

Switch 6:

Selects Output Action for OUT 1/OUT 2
Heat/Heat or Heat/Cool.

Switch 8:

Selects Deviation Alarm Type
High or Low Deviation, or Deviation Band.

Operating Data and Parameters - DIP Switch #1

DIP Switch #1 adds to the Operating Data and Parameters Box LED Display prompts according to its position. It also places different information in the DIGITAL display.

DIP Switch #1 OFF enables display of Operating Data, SET 1 and SET 2 (set points).

DIP Switch #1 ON enables display of Operating Parameters, P (Proportional Band), r (Reset), d (Rate), c (Cycle Time), o (Calibration offset), A (Auto-tune) and Operating Data, SET 1 and SET 2.

Enter Operating Data and Operating Parameters

DIP Switch #1 must be OFF to select Operating Data and Operating Parameters. Pressing only the MODE key will allow you to move through the LED prompts without changing data. Using the UP or DOWN keys will enable you to change the values in the DIGITAL display. New values in the DIGITAL display will flash until you press the ENTER key. Pressing MODE key will move you to the next LED prompt.

Operating Data (DIP Switch #1 must be ON to change)

SET 1	Set Point 1 is adjustable over the full range of the input type.		
Type J t/c	32 to 1382°F	or	0 to 750°C
Type K t/c	-328 to 2282°F	or	-200 to 1250°C
Type T t/c	-328 to 662°F	or	-200 to 350°C
RTD 1°	-328 to 1112°F	or	-200 to 600°C
RTD 0.1°	-94.0 to 392.0°F	or	-70.0 to 200.0°C

SET 2 Set Point 2 is also adjustable over the full range of the input type when SET 2 is a process type set point. As a deviation set point, SET 2 is adjustable over a $\pm 500^\circ$ for whole degrees units or ± 99.9 for RTD 0.1 range from SET 1.

Operating Parameters (DIP Switch #1 must be ON to change)

- P** **Proportional Band.** Set the PROPORTIONAL BANDWIDTH for Output 1, adjustable from 0° to 500°C or $^\circ\text{F}$ for ranges displayed in whole degrees, and 0 to 99.9°C or $^\circ\text{F}$ for ranges displayed in 1/10 degrees. If set at $P = 0$, the Series 910C will function as a simple ON/OFF control with a 3°F or 1.7°C switching differential for ranges displayed in whole degrees, and 0.3°F or 0.17°C for ranges displayed in 1/10 degrees.
- r** **Reset.** Enter RESET for Output 1, adjustable from 0.00 to 2.00 repeats per minute. Selecting 0.00 = no reset action.
- d** **Rate.** Adjust RATE function for Output 1 from 0.00 to 5.00 minutes maximum. Selecting 0.00 = no rate action.
- c** **Cycle Time.** Enter the CYCLE TIME for Output 1, adjustable from 1 to 30 seconds.
- o** **Calibration Offset.** Usually 0° at first, you can enter a value from -10 to 10°C or $^\circ\text{F}$ for T/C or whole degree RTDs, and $\pm 9.9^\circ\text{C}$ or $^\circ\text{F}$ for tenths of a degree RTDs. Calibration Offset adds or subtracts degrees from the input signal.
- A** **Auto-Tune.** The range of this parameter is 0-3, characterizing off, slow, medium, and fast thermal system responses. A value other than 0 initiates the auto-tune.

Set Up Charts with Default Parameters



Set Up Chart

Use this page as a master copy for all your Series 910 set ups. Do not enter values here, but make photocopies instead.

NOTE:
DIP switch #6 must be OFF, #4 must be ON.

NOTE:
Position of DIP switch #6 determines high deviation or low deviation. DIP switch #4 must be ON.

**Chart 1 -
Series 910
Set Up with
Default
Parameters**

DIP Sw#	Function		Normal Operation	Factory Default	Current Position
	OFF	ON			
1	Display Operating Data Only	Set All Data and Parameters	OFF	ON	
2	Select Input Type: See Sensor Table		Choose	OFF	
3	Select Input Type: See Sensor Table		Choose	OFF	
4	SET 2 as Process Set Point	SET 2 as Deviation Set Point	Choose	OFF	
5	Fahrenheit °s Displayed	Celsius °s Displayed	Choose	OFF	
6	Heat/Heat Output Action	Heat/Cool Output Action	Choose	OFF	
7	Normal Operation	Install Default Values	OFF	OFF	
8	High or Low Deviation 	Deviation Band 	Choose	OFF	

Input Type	DIP #2	DIP #3	Range	Current T/C Type
Jt/c	OFF	OFF	32 to 1382°F or 0 to 750°C	
Kt/c	ON	OFF	-328 to 2282°F or -200 to 1250°C	
Tt/c	OFF	ON	-328 to 662°F or -200 to 350°C	
RTD 1°	ON	ON	-328 to 1112°F or -200 to 600°C	
RTD 0.1°	ON	ON	-94.0 to 392.0°F or -70.0 to 200.0°C	

Operating Data	Value	Range	Factory Default
SET 1		Per Input	77°F or 25°C
SET 2		Per Input	77°F or 25°C
Operating Parameters (Output 1)			
P		0 to 500°C or °F or 0 to 99.9°C or °F 0=ON/OFF control with 3°F or 1.7°C switching differential. .3°F or .17°C for .1° units.	25°C or 45°F
r		0.00 to 2.00rpts/min 0.00=No Reset Action	0.00repeats/min.
d		0.00 to 5.00min. 0.00 = No Rate Action	0.00min.
c		1 to 30sec.	5sec.
o		±9.9°C or °F for .1° units. ±10°C or °F	0°

Chapter 5

How to Tune and Operate

Tuning - Manual

For optimum control performance, tune the 910 to the thermal system. The tuning settings here are meant for a broad spectrum of applications; your system may have somewhat different requirements. The PID settings in the Operating Parameters apply only to SET 1 and OUT 1.

1. **Apply power to the Series 910** and enter a set point for SET 1. Put Set 2 at 0, or outside the proportional band. Set the Operating Parameters initially: $P = 0$, $r = 0.00$, $d = 0.00$, $c = 5$, $o = 0$, $A = 0$.

Allow actual process temperature to stabilize at or near Set Point 1 (SET 1). The ACTUAL display will indicate when the load is stabilized near SET 1, always the desired process control set point.

2. **Proportional Band Adjustment (OUT 1):** Gradually increase P until the DIGITAL display temperature stabilizes to a constant value. The temperature will not be right on set point because the initial reset value is 0.00 repeats per minute. (When "P" = 0, "r", "d" and "c" are inoperative, and the 910 functions as a simple ON/OFF control with a 3°F or 1.7°C switching differential.)
3. **Reset Adjustment:** Gradually increase "r" until the DIGITAL display temperature begins to oscillate or "hunt". Then slowly decrease "r" until the DIGITAL display stabilizes again near SET 1. NOTE: This is a slow procedure, taking from minutes to hours to obtain optimum value.
4. **Cycle Time Adjustment:** Set "c" as required. Optimum system control is always achieved with faster cycle times. However, if a mechanical contactor or solenoid is switching power to the load, a longer cycle time may be desirable to minimize wear on the mechanical components. Experiment until the cycle time is consistent with the quality of control you want.
5. **Rate Adjustment:** Increase "d" to 1.00 min. Then raise SET 1 by 20° to 30°F, or 11° to 17°C. Observe the system's approach to SET 1. If the load temperature overshoots SET 1, increase "d" to 2.00 minutes.

Then raise SET 1 by 20 to 30°F, or 11 to 17°C and watch the approach to the new set point. If "d" is advanced too far, approach to the set point will be very sluggish. Repeat as necessary until the system rises to the new set point without overshooting or approaching the set point too slowly.

6. **Calibration Offset Adjustment:** You may want your system to control to a temperature other than the value coming from the input sensor. If so, measure the difference (as much as -10 to 10°C or °F) between that temperature, perhaps at another point in the system, and the process value showing in the DIGITAL display. Then enter the amount of "o" offset you want. Calibration offset adds or subtracts degrees from the value of the input signal.

Tuning - Automatic

Auto-tuning: The Series 910 gives you the capability to automatically tune the PID parameters to fit the characteristics of your particular thermal system.

To auto-tune your Series 910, set DIP Switch #1 in the ON position to access the operating parameters. Adjust SET 1 to the desired control point.

The auto-tuning procedure operates on a thermal response value — slow, medium, or fast. A slow thermal response is used when the process temperature is not met too rapidly, or greatly exceeds the set point value. A fast thermal response produces a rapid temperature change over a short period of time.

Press the MODE key until the "A" prompt appears in the data display. Select a thermal response value, 1 =slow, 2=medium, and 3=fast using the UP/DOWN and Enter keys. A thermal response value of 2 will satisfactorily tune most thermal systems. The data display reverts to the actual temperature, and the process LED begins flashing. The LED is a visual indication that the auto-tuning process is taking place. When the process is complete, the process LED remains lit. The appropriate PID tuning parameters are now installed, and retained in the non-volatile memory.

The auto-tuning process may be aborted by pressing the MODE key until the A prompt appears in the data display. Set the thermal response value to 0.

The Relationship Between SET 1 and SET 2

SET 2 will operate as a deviation set point or a process set point.

As a deviation set point, SET 2 will always be a fixed relative degree distance from SET 1. As a process set point, SET 2 may be set to operate at any temperature within the operating range of the input sensor. SET 2 is an ON/OFF set point only, having no PID control parameters of its own.

You can also use SET 2 to energize a temperature related event output or an alarm device. Such a device would be either full ON or full OFF, depending on whether the actual process temperature is above or below SET 2, and whether SET 2 is in the Heat or Cool mode.

Accessing the Default Parameters

The Series 910 default parameters may be set by using DIP Switch #7. Place it in the ON position. Only those values that may be changed at the front panel will be set to default by this method. See p. 29 for the default values. To enter the default parameters into the 910's microprocessor memory from permanent storage, use this procedure:

1. **Disconnect the Series 910 outputs** from the thermal system. (The Series 910 outputs must be disconnected from the thermal system prior to entering the default parameters into the microprocessor. These parameters may differ significantly from the system parameters.)
2. **Remove power from the 910.** Turn the front panel screw 90° counter-clockwise. Pull the control chassis from the case by gripping the front panel bezel and pulling it outward.
3. **Set DIP Switch #7 to the ON position.** Replace the chassis in its case. Apply power to the Series 910 for at least one second. The default parameters are now in the processor's memory.
4. **Again remove the chassis from the case and turn #7 OFF.** If you want to begin entering parameters, set DIP Switch #1 ON.
5. **Return the chassis to the case, secure the front panel screw.** Apply power to the 910. The values that now appear are the default parameters listed. The default parameters will remain in the processor until you change them.

How To Deal With Error Codes

When something goes wrong with the 910 itself, the control will show an "E+digit(s)" error code and shut down the outputs. To clear the error conditions, you must first correct the error.

Error Codes and What To Do

1

RAM failure error

Noise: Remove, then reapply power to the 910. If error persists, determine if the 910 is near a noise source. If so, eliminate the noise or relocate the control.

Process failure: If the error codes continues to appear after testing for noise and more than one new location for the control, then consult the factory for assistance.

2, 3

Not used

4

Stack Crash

Noise: Remove, then reapply power to the 910. If error persists, determine if the 910 is near a noise source. If so, eliminate the noise or relocate the control.

Process failure: If the error codes continues to appear after testing for noise and more than one new location for the control, then consult the factory for assistance.

5

A/D conversion over-range voltage error

Noise: Remove, then reapply power to 910. If error persists, determine if the 910 is near a noise source. If so, eliminate the noise or relocate the control.

Vibration: Determine if the Series 910 is subject to a source of vibration. If that is the case, take steps to dampen the vibration or relocate the control.

A/D conversion failure: If after determining that neither noise nor vibration is the problem, and the control continues to show an error after removing and restoring power, then consult the factory.

6

Open sensor (A/D conversion) error for thermocouple

Thermocouple open failure: This error code is "self-clearable," i.e. if the thermocouple is intermittent, the Series 910 may be found showing an "E 6", yet still be functioning. If however the Series 910 has shut down and the error code is showing the DIGITAL display, remove power from the unit. Read the resistance across Terminals #1 and #3; an open sensor will show. Replace if defective.

Noise: Remove, then reapply power to 910. If error persists, determine if the 910 is near a noise source. If so, eliminate the noise or relocate the control.

Vibration: Determine if the Series 910 is subject to a source of vibration. If that is the case, take steps to dampen the vibration or relocate the control.

A/D conversion failure: If after determining that neither noise nor vibration is the problem, and the control continues to show an error after removing and restoring power, then consult the factory.

7, 8, 9

A/D conversion over-range voltage error

Noise: Remove, then reapply power to 910. If error persists, determine if the 910 is near a noise source. If so, eliminate the noise or relocate the control.

Vibration: Determine if the Series 910 is subject to a source of vibration. If that is the case, take steps to dampen the vibration or relocate the control.

A/D conversion failure: If after determining that neither noise nor vibration is the problem, and the control continues to show an error after removing and restoring power, then consult the factory.

10

Open/shorted sensor (A/D conversion) error for RTD

This error code is "self-clearable," i.e. if the RTD is intermittent, the Series 910 may be found showing an "E10", yet still be functioning. If, however, the Series 910 has shut down and the error code is showing on the DIGITAL display, remove power from the unit. Read the resistance across terminals #4 and #5. Either 0 ohms or an open sensor will show. Replace if defective. A good sensor should read 0 ohms between terminals #5 and #6.

11, 12

Not used

13

Input Error

The processor is unable to find a value for the input thermocouple voltage: First check to see that the input type is correctly entered at DIP #2 and DIP #3. An incorrect entry can cause this error.

Failure due to an open thermocouple or RTD: This error code is "self-clearable," i.e. if the thermocouple is intermittent, the Series 910 may be found showing an "E13", yet still be functioning. If, however, the Series 910 has shut down and the error code is showing on the DIGITAL display, remove power from the unit. Read the resistance across terminals #1 and #3 for thermocouple units, or across terminals #4 and #5 for RTD units. An open sensor will read an infinite resistance. Replace if defective.

Noise: Remove, then reapply power to the 910. If the error persists, determine if the 910 is near a noise source. If so, eliminate the noise or relocate the control.

Vibration: Determine if the Series 910 is subject to a source of vibration. If that is the case, take steps to dampen the vibration or relocate the control.

14

Not used

15

Non-volatile memory check-sum error

The Series 910 always checks the memory data upon "power up". If this information is not the same as that the processor remembered at the previous "power down", this error appears. First, recycle the power into the Series 910, OFF, then ON again. If the error codes does not reappear, then re-enter your parameters. Error code 15 will cause the Series 910 to seek its default parameters which will replace your parameters. Thus you must re- enter your parameters before operating again. (Caution: Do not apply load power to the Series 910 output circuits until you have re-entered all your parameters. The default parameters may differ greatly from your system parameters). If the error code does not reappear, you may consider the problem an isolated incident. If the error code returns, consult the factory for assistance .

Noise: Determine if the 910 is near a noise source. If so, eliminate the noise or relocate the control.

16

RTD offset error

The value received from non-volatile memory was too far out of limits.

If this error occurs, the RTD section is now out of calibration. Consult the factory.

17

RTD gain error

The value received from non-volatile memory was too far out of limits.

If this error occurs, the RTD section is now out of calibration. Consult the factory.

18

High reference error

Value received from non-volatile memory was too far out of limits -

If this error occurs, the unit is now out of calibration. Consult the factory.

19

Cold junction error

Value received from non-volatile memory was too far out of limits.

If this error occurs, the thermocouple section is now out of calibration. Consult the factory.

20

Over/Under Ambient Error

If this error occurs, the ambient temperature at the terminal strip is either above or below the recommended operating temperature. This is a self-clearing error

21

4-20mA output error

The 4-20mA output gain is out of limits. Consult the factory.

22

4-20mA output error

The 4-20mA offset is out of limits. Consult the factory.

Appendix

Series 910 Model Number Breakdown

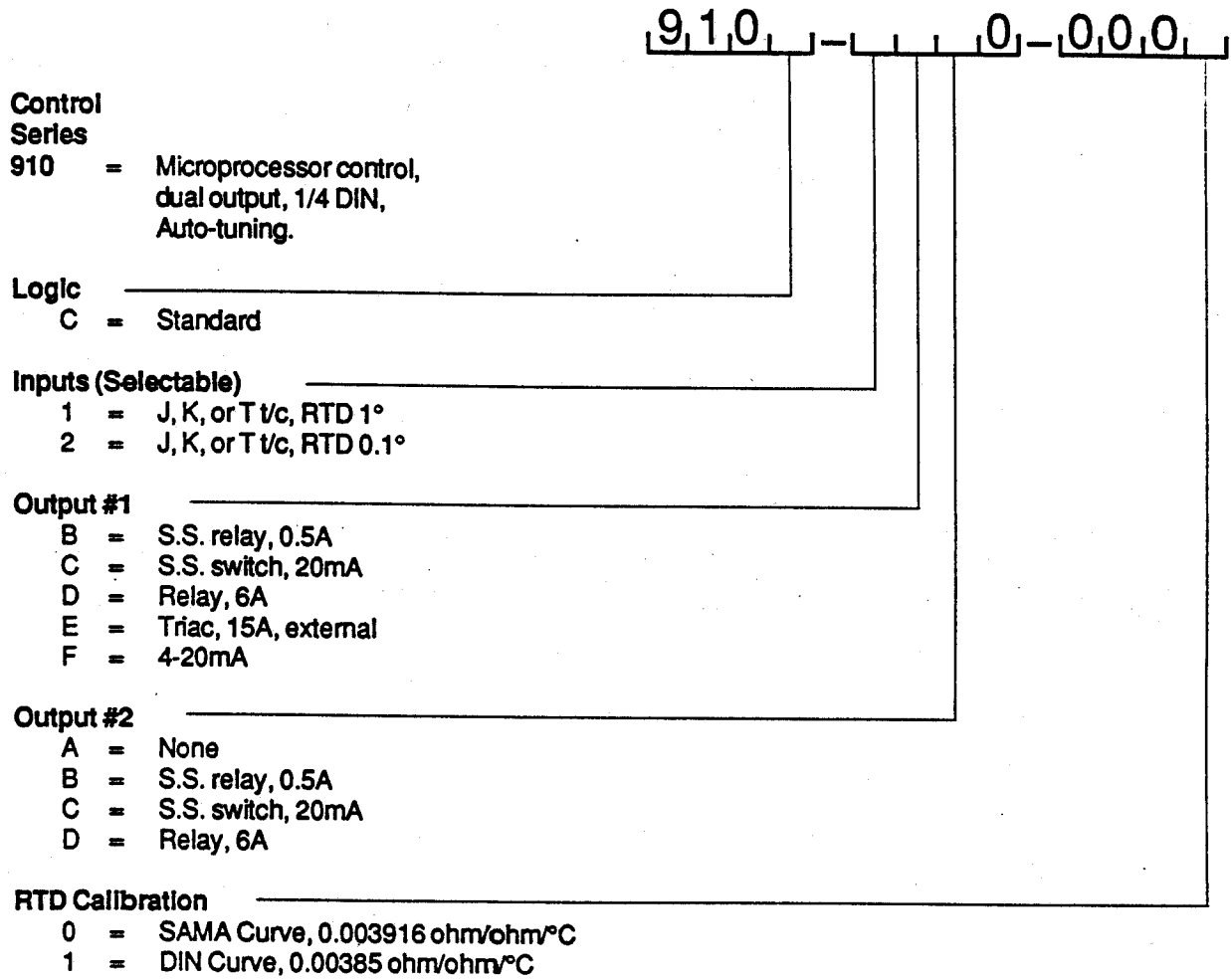

Series 910 Specifications

Control Mode

- Microprocessor-based, user selectable modes.
- Single input, dual outputs.
- Output #1: User selectable as:
 - ◊ ON/OFF, P, PI, PD, PID, Heat Action.
 - ◊ ON/OFF: 3°F or 1.7°C switching differential.
 - ◊ ON/OFF: 0.3°F or 0.17°C switching differential for 0.1° RTD.
 - ◊ Proportional band: 0 to 500°C or °F or 0 to 99.9 °C or °F for 0.1° RTD.
 - ◊ Reset: 0.00 to 2.00 repeats per minute.
 - ◊ Rate: 0.00 to 5.00 minutes.
 - ◊ Cycle time: 1 to 30 seconds.
- Output #2: User selectable as:
 - ◊ Process or deviation from primary set point.
 - ◊ Heat or Cool action.
 - ◊ ON/OFF: 3°F or 1.7°C switching differential.
 - ◊ ON/OFF: 0.3°F or 0.17°C switching differential for 0.1° RTD.

Operator Interface

- Membrane front panel.
- Four digit, seven-segment, 1/2" red LEDs displaying process input value or control parameters.
- MODE, ENTER, UP and DOWN keys.

Input

- Thermocouple process input, linearization throughout the range, $\pm 0.25\%$ of span.
- Automatic cold junction compensation for thermocouple.
- Sensor break protection de-energizes output to protect system.
- Sensor may be isolated or grounded.
- Operating ranges user selectable. The range units are dependent upon the type of input.

J t/c:	32 to 1382°F	or	0 to 750°C
K t/c:	-328 to 2282°F	or	-200 to 1250°C
T t/c:	-328 to 662°F	or	-200 to 350°C
1° RTD:	-328 to 1112°F	or	-200 to 600°C
0.1° RTD:	-94.0 to 392.0°F	or	-70.0 to 200.0°C
- Calibration offset of input signal, $\pm 10^\circ\text{F}$ or C, user-selectable, $\pm 9.9^\circ\text{F}$ or C for 0.1° RTD.
- °F or °C are user selectable.

Output Options

Output #1

- Mechanical Relay, 6A SPDT: 6A @ 115/230VAC $\pm 10\%$, 6A @ 28VDC, 1/8 hp @ 115VAC, 125VA Pilot Duty @ 115VAC. Form 'C' contact configuration.
- Solid State Relay, 0.5A @ 24VAC minimum, 253VAC maximum, opto-isolated, zero-cross switching. 5mA minimum load.
- Solid State Switch, 20mA and 20VDC max, open collector switch-to-ground.
- Triac 15A @ 24VAC minimum, 253VAC maximum, 100mA min load, mounted external on rear of case.
- 4-20mA reverse acting, (heating)proportional current into 600 Ω maximum impedance.

Output #2

- Mechanical Relay, 6A SPST: 6A @ 115/230VAC $\pm 10\%$, 6A @ 28VDC, 1/8 hp @ 125VAC, 125VA Pilot Duty @ 230VAC. Form 'A' contact configuration.
- Solid State Relay, 0.5A @ 24VAC minimum, 253VAC maximum, opto-isolated, zero-cross switching.
- Solid State Switch, 20mA and 20VDC max, open collector switch-to-ground.

Accuracy

- Rated Accuracy: $\pm 0.25\%$ of span, ± 1 L.S.D.
- Temperature Stability: $\pm 3.6\mu\text{V}/^\circ\text{C}$, referred to the input.
- Set Point Shift with Line Voltage: $\pm 0.15\%$ of span for a 10% shift in AC supply voltage.

Terminals

- Compression type screws terminals for 14-20ga. wire.

Power

- 115/230VAC $\pm 10\%$, 50/60Hz.
- Noise Rejection: 120db @ 60Hz., 115VAC rms common mode; and 60db @ 60Hz., 200mV or 5 times span @ 60Hz., normal mode.
- Power Requirement: less than 7VA.
- Data retention upon power failure via nonvolatile memory.

Operating Environment

- 32 to 130°F/0 to 55°C.
- 0 to 90% RH, non-condensing.
- Storage Temperature: -40 to 158°F or -40 to 70°C

Dimensions

- Height: 3.81 in.
- Width: 3.81 in.
- Overall depth: 6.92 in.
- Behind panel depth: 6.00 in.
- With 15A triac: 8.50 in. minimum
- Weight: 2.25 lb.

Thermocouple Field Calibration Procedure

Equipment Required

- Type "K", "J", or "T" Reference Compensator with reference junction at 0°C or 32°F.
- 4-1/2 digit Digital Voltmeter (DVM).

Set-Up And Calibration

NOTE

Before calibration on an installed control, make sure all data and parameters are documented. See Set Up Chart, p. 29.

1. Set J2 (blue jumper) on the A007-1691 board to the CAL position. Set DIP Switch #2 and #3 to match the compensator.
2. Connect the input side of thermocouple reference compensator to #1 Positive and #3 Negative. Short the output side of the compensator. Turn the compensator on. See Figure 28.

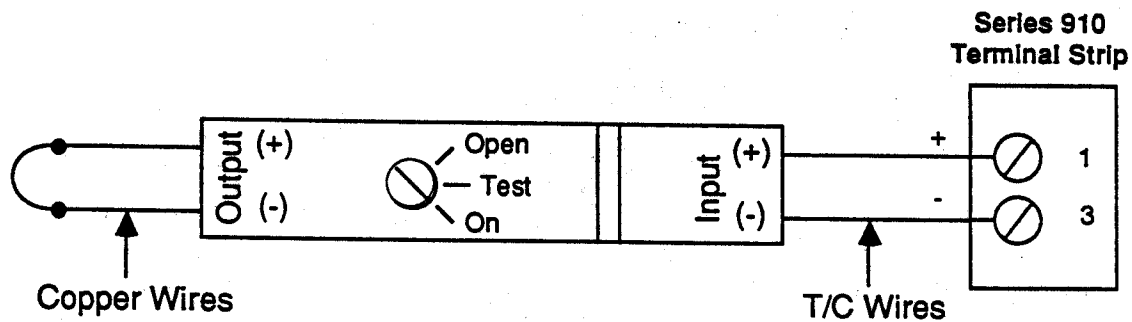

Figure 28 -
Reference Compensator-to-Series
910 Connection
Diagram

Omega Model
MCJ-J
MCJ-K
MCJ-T

3. Connect the A.C. line voltage, L1 to #9, L2 to #10, ground to #11. Make sure the internal jumpers are set for the correct line voltage.
4. Apply power to the unit and allow it to warm up for 15 minutes.
5. Using the "MODE" key, advance until "SET 1" is lit. Connect the DVM common to TP100 and DVM positive to TP1 on the A007-1691 circuit board. The DVM should be set up for DC volts, and in a range capable of displaying 32.00 millivolts.

5. Using the "MODE" key, advance until "SET 1" is lit. Connect the DVM common to TP100 and DVM positive to TP1 on the A007-1691 circuit board. The DVM should be set up for DC volts, and in a range capable of displaying 32.00 millivolts.
6. Use the UP/DOWN keys to adjust the front panel display on the 910 to match the reading on the DVM. Once the two readings match, press the "ENTER" key.
7. Press the "MODE" key. "SET 2" will be lit. Press the "ENTER" key. The unit is now calibrated.
8. Press the "MODE" key until the process LED is lit. The reading on the 910 display should be 32°F or 0°C.
9. Remove power from the Series 910. Remove the thermocouple wires from #1 and #3. Turn off the compensator. Set J2 (blue jumper) on the A007-1691 board to the RUN position.

♪ NOTE

- With J2 in the CAL position, the outputs will be OFF.
- In Step 8, pressing the "MODE" key will skip over the display test which is not required for calibration. The display test is a visual test only.

RTD Calibration

RTD Field Calibration Procedure

Equipment Required

- 100 Ω precision decade resistance box with 0.01 ohms resolution.
- 4-1/2 digit, digital voltmeter (DVM).

Set-Up and Calibration

NOTE

Before calibration on an installed control, make sure all data and parameters are documented. See Set Up Chart, p. 29.

1. Set J2 (blue plastic connector) from the RUN position to the CAL position on the A007-1691 circuit board. Set DIP switch #2 and #3 to the RTD setting (both on).
2. Connect the precision decade box to #4, #5, and #6 as shown in Figure 29.

NOTE

Ground and Low are jumpered together on the decade resistance box.

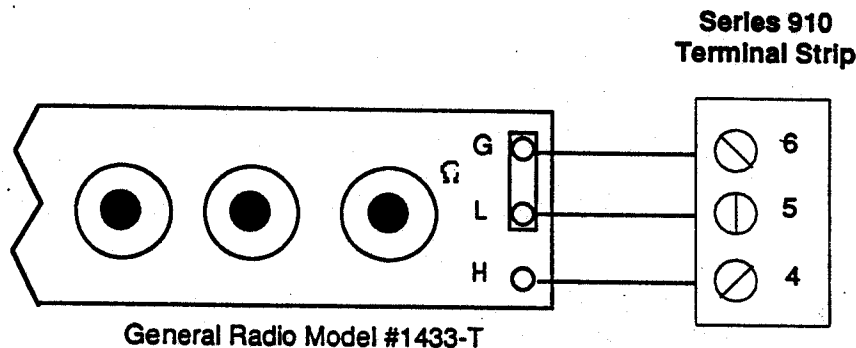

Figure 29 -
Decade Resistance
Box-to- Series 910
Connection
Diagram

3. Connect the AC line voltage, L1 to #9, L2 to #10, earth ground to #11. Make sure the internal jumpers are set for the correct line voltage.
4. Apply power to the unit and allow it to warm up for 15 minutes.
5. Using the "MODE" key, advance until "SET1" is lit. Connect DVM common to TP100 and DVM positive to TP1 on the A007-1691 circuit board. DVM should be set up for DC volts, and in a range capable of displaying 32.00 millivolts.

6. Use the UP/DOWN keys to adjust the front panel display on the 910 to match the reading on the DVM. Once the two readings match, press the "ENTER" key.
7. Press the "MODE" key until "OUT 1" is lit. Set the precision decade box to the correct LOW setting from Table 6, that corresponds to the type of 910 unit you have. Allow 10 seconds for settling and then press the "ENTER" key.
8. Press the "MODE" key until "OUT2" is lit. Set the precision decade box to the correct HIGH setting from Table 6, that corresponds to the type of 910 unit you have. Allow 10 seconds for settling and then press the "ENTER" key. The unit is now calibrated for RTD.
9. Remove power from the Series 910. Remove wires from #4, #5, and #6. Set J2 (blue plastic connector) from the CAL position to the RUN position on the A007- 1691 circuit board.

 **NOTE**

With J2 in the CAL position, the outputs will be OFF.

Calibration	Low	High
1° SAMA	17.31	317.33
1° DIN	18.49	313.59
0.1° SAMA	71.85	177.13
0.1° DIN	72.33	175.84

**Table 6 -
RTD Calibration
Settings**

4-20mA Process Output Field Calibration

Equipment Required

- 499 Ω , 1/2 watt resistor.
- A multimeter.

Set Up and Calibration

NOTE:

Before calibration on an installed control, make sure all data and parameters are documented. See Set Up Chart, p. 29.

1. Set J2 (blue plastic connector) from the RUN position to the CAL position on the A007-1691 circuit board.
2. Connect the multimeter in series with the 499 Ω resistor across Terminals #15 and #16 on the back of the 910. See Figure 30.

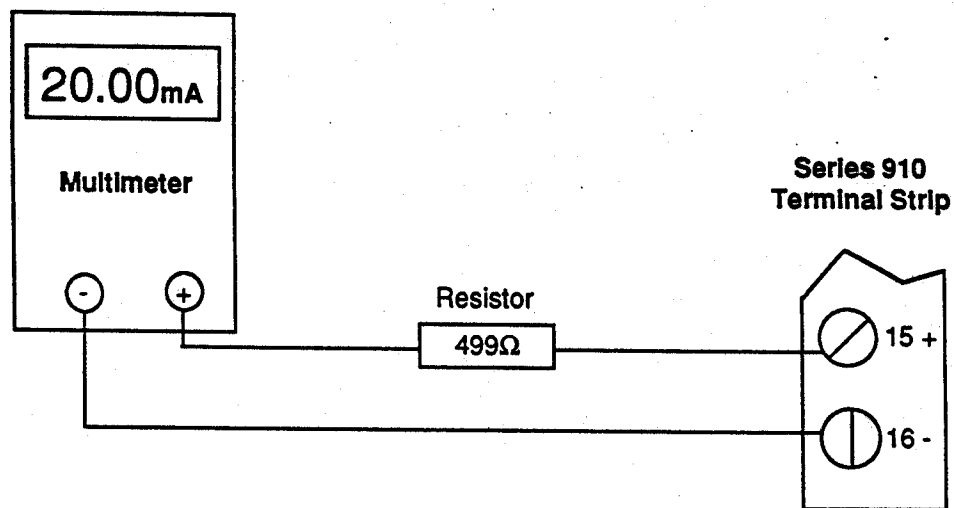

Figure 30 -
Multimeter to
Series 910
Connection
Diagram

3. Connect the AC line voltage, L1 to #9, L2 to #10, earth ground to #11. Make sure the internal jumpers on A007-1694 are set for the correct line voltage. Refer to Chapter 2, "Jumper Selection Before Power Wiring" for their location.
4. Apply power to the unit and allow it to warm up for 15 minutes.
5. Press the MODE key until the OUT2 LED is lit, then press the MODE key one more time; the OUT2 LED goes OFF. The multimeter should read approximately 20mA.
6. If not, use the UP/DOWN keys and press ENTER to adjust the displayed value until the multimeter display reads 4.0mA \pm 0.2mA. Allow 10 seconds for settling.

7. Press the MODE key once more. The multimeter displays approximately 4mA.
8. If not, use the UP/DOWN keys and ENTER key to adjust the displayed value until the output reads $4.0\text{mA} \pm 0.2\text{mA}$. Allow 10 seconds for settling.
9. Press the MODE key once more. The 910 displays LOOP.
10. If an adjustment was necessary in either Step 6 or 8 above, press the ENTER key to repeat the Adjustment loop, and go back to step 6.
11. Repeat the loop (Steps 6-10) until both readings are correct without any further adjustment. With LOOP displayed on the Series 910 display, press the MODE key to proceed.
12. The Series 910 process output is now calibrated for 4-20mA.
13. To check the accuracy of the output at points other than 0% (4mA) and 100% (20mA), enter the percentage on the 910 front panel and check the output current.

Example:

14. Enter the value 50 for 50%. The multimeter display should read 12mA.
15. Remove power from the Series 910. Remove wires from Terminals #15 and #16. Set J2 (blue plastic connector) from the CAL position to the RUN position on the A007-1691 circuit board.

NOTE:

With J2 in the CAL position, the outputs will be OFF.

Glossary A-O

This glossary includes general thermal system control terms.

- Actual display data:** Displayed information which gives the operator/programmer real or "actual" data, i.e., actual process temperature. See "Programmed display data."
- Alarm:** A condition, generated by a controller, indicating that the process has exceeded or fallen below the set or limit point.
- Anti-reset:** Control feature that inhibits automatic reset action outside of the proportional band.
- Automatic prompts:** Data entry points where a microprocessor-based control "prompts" or asks the operator/programmer for information input.
- Closed loop:** Control system that has a sensing device for process variable feedback.
- Cold junction:** Point of connection between thermocouple metals and the electronic instrument.
- Cold junction compensation:** Electronic means used to compensate for the effect of temperature at the cold junction.
- Cold start:** A "clean," or completely cleared-of-user-program-information, start-up condition. (Factory settings.)
- Cycle time:** The time necessary to complete a full ON-through-OFF period in a time proportioning control system.
- Dead band:** A temperature band between heating and cooling functions.
- Derivative:** Anticipatory action that senses the rate of change of temperature, and compensates to minimize overshoot and undershoot. Also "rate."
- Deviation:** The difference between the value of the controlled variable and the value at which it is being controlled.
- Default parameters:** The parameters, or programmed instructions, which are permanently stored in microprocessor software to provide a data base.
- DIP switch:** A Dual In-line Package switch.
- DIN:** Deutsche Industrial Norms, a widely-recognized German standard for engineering units.
- Display capability:** In a digital indicating instrument, the entire span that can be indicated if fully utilized.
- Droop:** Difference in temperature between set point and stabilized process temperature.
- Duty cycle:** Percentage of "load ON time" relative to total cycle time.
- Hysteresis:** In ON/OFF control, the temperature change necessary to change the output from full ON to full OFF.
- Hunting:** Oscillation or fluctuation of process temperature between set point and process variable.
- Input:** Process variable information being supplied to the instrument.
- Integral:** Control action that automatically eliminates offset, or "droop," between set point and actual process temperature. Also "reset."
- Isolation:** Electrical separation of sensor from high voltage circuitry. Allows for application of grounded or ungrounded sensing element.
- Offset:** Adjustment to actual input temperature and to the temperature values the Series 910 uses for display and control.
- ON/OFF control:** Control of temperature about a set point by turning the output full ON below set point and full OFF above set point in the heat mode.
- Open loop:** Control system with no sensory feedback. The Series 910 uses closed loop.
- Output:** Action in response to difference between set point and process variable.

Overshoot:	Condition where temperature exceeds setpoint due to initial power up or process changes.
P control:	Proportioning control.
Parameter:	A physical property whose value determines the response of an electronic control to given inputs.
PD control:	Proportioning control with rate action.
PI control:	Proportioning control with auto-reset.
PID control:	Proportioning control with auto-reset and rate.
Process variable:	Thermal system element to be regulated, such as time, temperature, relative humidity, etc.
Programmed display data:	Displayed information which gives the operator/programmer the "programmed" or intended process information, i.e., intended set point, intended alarm limit, etc. See "Actual displayed data."
Proportional band:	Span of temperature about the set point where time proportional control action takes place.
Proportioning control:	See Time proportioning control.
Rate:	Anticipatory action that senses the rate of change of temperature and compensates to minimize overshoot. Also "derivative."
Rate Band:	A thermal control band that defines where the rate (derivative) function begins. A Watlow rate band occurs centered on set point at one or more times the width of the proportional band.
Reference junction:	Synonymous with cold junction. See "Cold junction."
Reset:	Control action that automatically eliminates offset, or "droop," between set point and actual process temperature. Also "integral."
Reset windup inhibit:	Synonymous with anti-reset. See "Anti-reset."
RTD:	Resistance Temperature Detector. Resistive sensing device displaying resistance versus temperature characteristics. Displays positive temperature coefficient.
Set point:	Intended value of the process variable.
Switching sensitivity:	In ON/OFF control, the temperature change necessary to change the output from full ON to full OFF.
Thermal system:	A regulated environment consisting of a heat source, heat transfer medium, sensing device and a process variable control instrument.
Thermocouple:	Temperature sensing device that is constructed of two dissimilar metals wherein a measurable, predictable voltage is generated corresponding to temperature.
Thermocouple break protection:	Fail-safe operation that assures output shutdown upon an open thermocouple condition.
Three mode control:	Proportioning control with reset and rate.
Time Proportioning Control:	Action which varies the amount of ON and OFF time when "close" to the set point, i.e., in the proportional band. This variance is proportional to the difference between the set point and the actual process temperature. In other words, the amount of time the output relay is energized depends on the system temperature.
Triac:	Solid state switching device.
Warm Start:	Start-up condition where all program information is remembered by the instrument's memory back-up protection.
Zero switching:	Action that provides output switching only at the zero voltage crossing points of the AC line.

Index

- A**
 - Appendix, 35
 - Auto-tuning, 30
- B, C**
 - Calibration, 38
 - Clean Input Power, The Do's And Don'ts, 13
 - Combination Differential Filter, 15, Fig. 7
 - Common Mode Filter Wiring, 15, Fig. 6
- D**
 - Decade Resistance Box-to-Series 910 Connection Diagram, 40, Fig. 29
 - Decrease Noise Sensitivity, How To, 10
 - Default Parameters, 31
 - Default Parameters, 910 Set Up 29, Chart 1
 - Differential Mode Filter Wiring, 15, Fig. 5
 - DIGITAL Display, 24, Fig. 25
 - Dimensions,
 - Faceplate 16, Fig. 8
 - Panel Cutout, 17, Fig. 10
 - Sideview, 17, Fig. 9
 - DIP Switch,
 - #1, 27
 - Location, 7, Fig. 3
 - Selection, 7, Table 1 & 4
 - DIP Switches, 26
 - How To Set, 7
- E**
 - Eliminate Noise, How To, 11
 - Enter Operating Data And Operating Parameters, 28
 - Error Codes, 32
- F, G**
 - Glossary, 42
 - Ground Loops, 14
- H**
 - How To,
 - Install And Wire The Series 910 - Chapter 2, 9
 - Install The Series 910, 16
 - Open The 910, 6, Fig. 2
 - Set Up The Series 910 - Chapter 4, 26
 - Tune And Operate - Chapter 5, 30
 - Use The Keys And Displays - Chapter 3, 24
 - Wire Power For The Series 910, 23
 - Wire The Series 910, 18
- I**
 - Index, 45
 - Information Resource, 9
 - Input Power Definitions, 12
 - Installation Parameters, 27
- J**
 - Jumper Selection, 115/230VAC, 22, Fig. 22
- K**
 - Keys, 24, Fig. 24
- L**
 - Line Filtering Configurations, 15
- M**
 - Mechanical Relay,
 - Output 1 Wiring, 19, Fig. 14
 - Output 2 Wiring, 20, Fig. 20
 - Microprocessor Are In a Way Like Trout..., 12
 - Microprocessor-Based Control - Chapter 1, 4
 - Model Number, 35
 - Modes, Overview, 8
 - Multimeter to Series 910 Connection Diagram, 42, Fig. 30
- N**
 - No Output 2, 20, Fig. 17
 - Noise,
 - Sources, 10
 - Suppression Device Ratings, 14, Table 3
 - Suppression Devices, 14
- O**
 - Open The 910, How To, 6
 - Operating Data, 25, Fig. 26
 - Operating Parameters, 25, Fig. 27
 - Output 1 Wiring,
 - 15A Triac, 19, Fig. 15
 - 4-20mA, 19, Fig. 16
 - Overview Of The 910 Operating Modes, 8, Fig. 4
- P**
 - Packing List, 5
 - Power Wiring, 23, Fig. 23
 - Power Wiring, Jumper Selection, 22
 - Preventing Noise, Installation Guidelines, 9
- Q, R**
 - Read Me First, 4
 - Reference Compensator-to-Series 910 Connection Diagram, 33, Fig. 28
 - Returns, 47
 - RTD Calibration Settings, 41, Table 6
 - RTD Sensor Wiring, 18, Fig. 11
- S**
 - Sensor,
 - Installation, 9
 - Type Selection, 7, Table 2 & 5
 - Wiring, 18, Fig. 11
 - Series 910 Input And Output Overview, 4, Fig. 1
 - SET 1 And SET 2, The Relationship Between, 31
 - Set Up Chart, 29
 - Specifications, 36
 - SS Relay,
 - Output 1 Wiring, 18, Fig. 12
 - Output 2 Wiring, 20, Fig. 18
 - SS Switch,
 - Output 1 Wiring, 19, Fig. 13
 - Output 2 Wiring, 20, Fig. 19
 - Steps To Put Your Control To Work, 5
 - System,
 - Planning, 9
 - Wiring Example, 21, Fig. 21
- T**
 - Thermocouple Sensor Wiring, 18, Fig. 11
 - Tuning, 30
- U, V, W**
 - Warranty, 45

Returns

Warranty

The following procedure applies for any products returned to the factory:

1. You must call Watlow Customer Service, 507/454-5300, for a Return Material Authorization (RMA) number before returning any item for repair. We need this information:
 - Ship to address
 - Bill to address
 - Contact name
 - Phone number
 - Ship via
 - Your P.O. number
 - Symptoms and/or special instructions
 - Name and phone number of person returning the material.

We will not accept a return without an RMA number. The RMA number must appear on the outside of the carton and on all paperwork. Cartons without RMA numbers will be returned. ship on a Freight Prepaid basis.

2. You need prior approval and an RMA number from the Customer Service Department when you are returning an unused product for credit. Also, we must apply a 20 percent restocking charge for all returned stock controls and accessories.
3. After we receive your return, we will examine it to determine the cause for your action.
4. In cases of manufacturing defect, we will enter a repair order, replacement order or issue credit for material.
5. If the unit is unrepairable, we will return it to you with a letter of explanation. Repair costs will not exceed 50 percent of the original cost.

Shipping Claims

When you receive your Watlow control, examine the package for any signs of external damage it may have sustained enroute. If there is apparent damage either outside the box or to its contents, make a claim with the shipper immediately. Save the original shipping carton and the packing material.

Warranty

The Watlow Series 910 is warranted to be free of defects in material and workmanship for 42 months after delivery to the first purchaser for use, providing that the units have not been misapplied.

Since Watlow has no control over their use, and sometimes misuse, we cannot guarantee against failure. Watlow's obligations hereunder, at Watlow's option, are limited to replacement, repair or refund of purchase price, and parts which upon examination prove to be defective within the warranty period specified. This warranty does not apply to damage resulting from transportation, alteration, misuse, or abuse.

Watlow Winona, Inc.

Watlow Winona, Inc. is a division of Watlow Electric Manufacturing Company of St. Louis, Missouri. Watlow is an established manufacturer of industrial electric heating products, in business since 1922. Watlow boasts the ability to begin with a full set of specifications and to complete an industrial product that is manufactured totally in-house, in the U.S.A. Products designed and manufactured by Watlow are electric heating elements, sensors, electronic controls and power switching devices. The Winona operation has been designing solid state electronic control devices since 1962, and has earned the reputation as an excellent supplier to original equipment manufacturers. These OEMs depend upon Watlow Winona to provide compatibly engineered controls which they can incorporate into their products with confidence. Watlow Winona, Inc. resides in a 100,000 square foot marketing, engineering and manufacturing facility in Winona, Minnesota.