

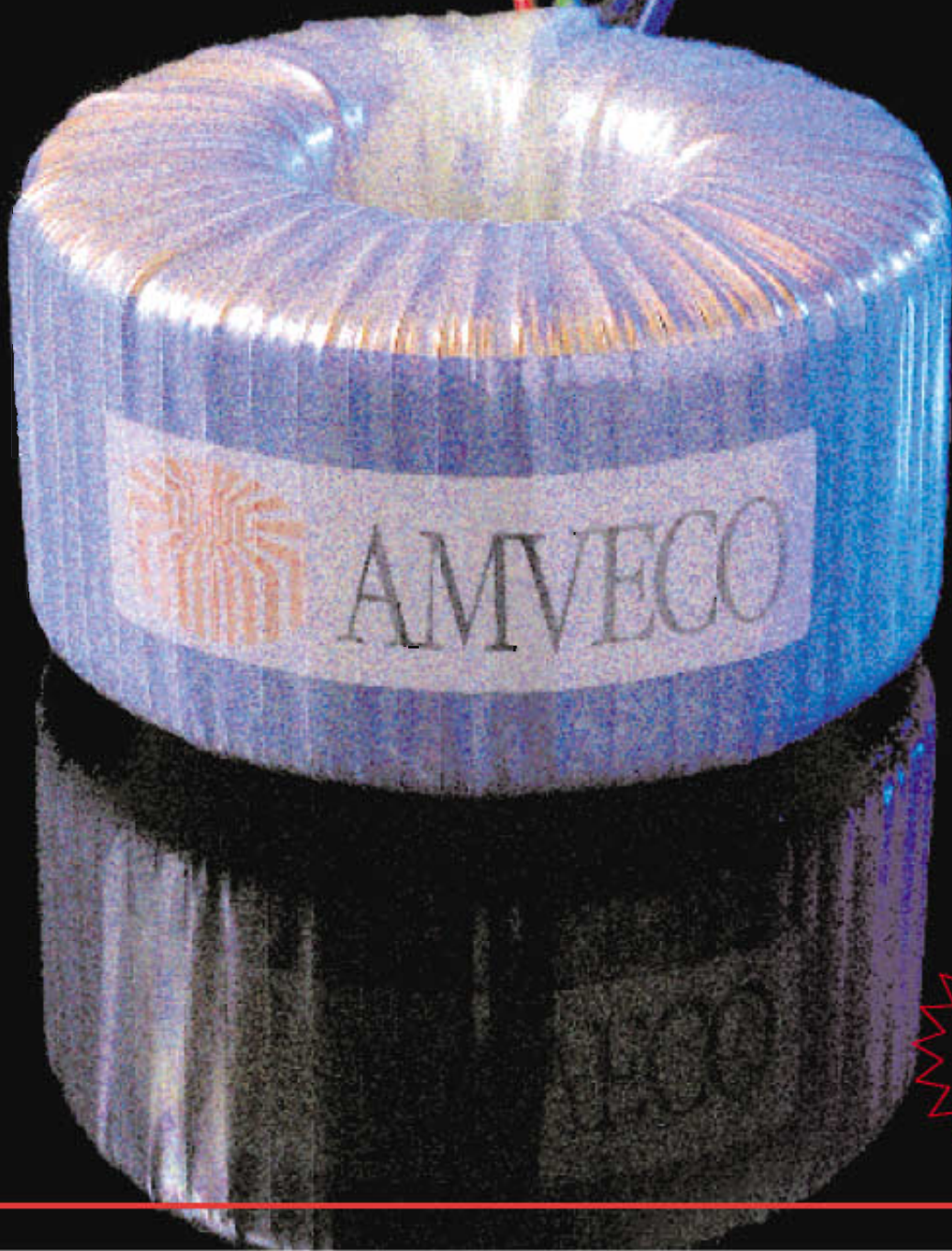

AMVECO
TOROIDAL POWER PRODUCTS



On this page you can learn about the advantages and benefits of using our toroidal transformers. First we would like to list four features that are unique to AMVECO and its line of toroidal transformers. Four features that you will surely benefit from.

- *AMVECO is an ISO 9001 registered company*
- *AMVECO's transformers use only flameretardent material (UL 94V2)*
- *AMVECO offers lifetime warranty for its products*
- *AMVECO's transformers are recognized to several UL standards and certified by CSA as well as TUV for medical applications.*



High Performance Products For Your High Performance Applications.



SMALL SIZE

Most toroids are smaller than their E-I transformer counterparts. Electrical and mechanical designers appreciate a toroid's compact dimensions. They are particularly well suited where low height is a consideration.



LOW STRAY MAGNETIC FIELD

Toroids have no airgaps: primaries and secondaries are wound uniformly around the entire core. As a result, toroids emit very low radiated magnetic fields. This makes the toroid ideal for applications involving high sensitivity circuitry.



LOW MECHANICAL HUM

The core of a toroid is formed from a single strip of grain-oriented electrical grade silicon steel tightly wound in the form of a clock spring with the ends spot-welded in place. The copper wire is wound over polyester film, forming a silent, stable unit without the use of environmentally unfriendly glues or varnishes.



FLEXIBLE DIMENSIONS

Compounding the benefits of low weight and small size is the flexibility to vary dimensions. Because AMVECO is not tied down to core caps or lamination sizes, the height and diameter of our toroids may be economically varied to accommodate equipment design requirements.



LOW WEIGHT

Because they are more efficient, toroids can be up to 50% lighter, (depending on power rating), than conventional laminated transformers. Low weight simplifies end product design by reducing mounting hardware and supporting enclosure requirements.



LOW NO-LOAD LOSSES

Compared to conventional E-I transformers, toroids exhibit extremely low no-load losses. In applications where a circuit is in a "stand-by" mode for long periods, the potential cost reduction for power can be significant, sometimes 80-90% lower.



HIGH EFFICIENCY

Due to its unique construction, toroids are typically between 15 and 30% more efficient than the conventional type. As a rule; the larger the transformer - the more efficient it becomes.



LOW OPERATING TEMPERATURE

Since most of the losses in a toroid are in the copperwire, the toroid cools off quicker than the conventional E-I type with more iron. At half the load, the toroid's temperature rise is only about 30% of what it is at full load.



EASY TO MOUNT

A single center screw easily and quickly mounts the toroid, avoiding costly mechanical design and practical problems associated with conventional E-I-laminated transformers..., and three screws are eliminated at assembly!



TABLE OF CONTENTS

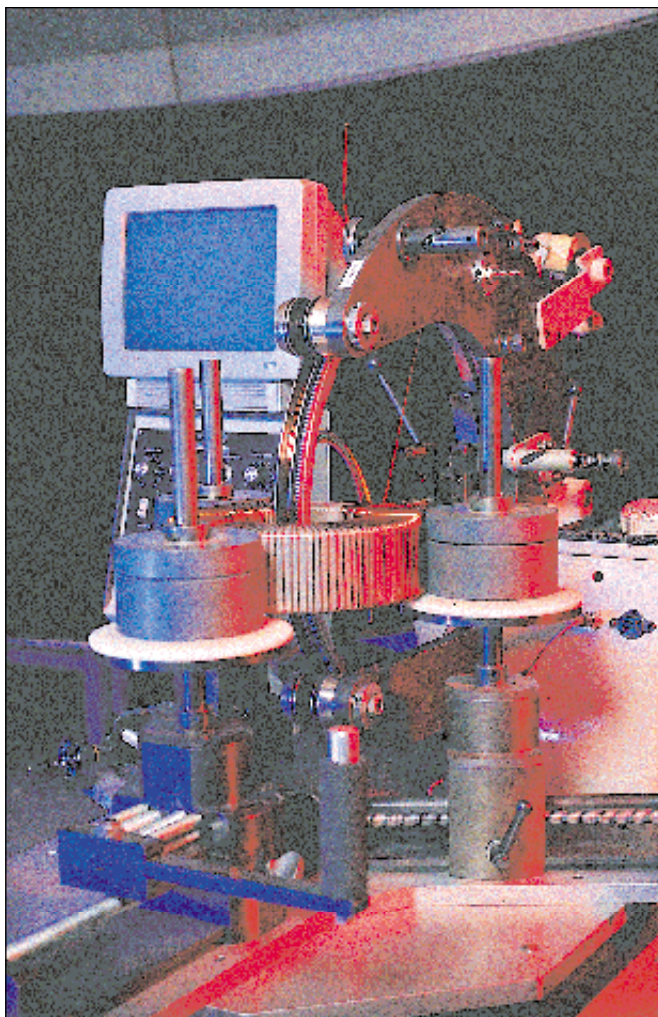

Features, Advantages and Benefits of Toroidal Power Transformers	1
Serving A Broad Range Of Industries	3
Value Added Assembly Service	3
Engineering Support	4
Interactive Website Design Service	4
Documented Reliability (ISO 9001 And Safety Standards)	5-6
AMVECO Construction Data	6
Technical Data And Application Notes	7-14
Reference Guide For Size And Losses	11
Customer Specification Sheet	12
Toroidal Mounting Methods	13-14
Considerations When Using Toroidal Power Transformers	15
Standard Design Transformers For 117V/60Hz Applications	16
Standard Design Transformers For 2x117V/50-60Hz Applications	17
Standard Design Medical Grade High Isolation Transformers	18
Custom Designed Auto-Transformers And Three-Phase Transformers	19
Current Sensing Transformers	20
Low Profile PC Mount Transformers	21
Low Profile Miniature Transformers	23
AMVECO Standard Series Inductors	25
Copy of AMVECO's ISO 9001 Certificate	26

THE SUPERIOR/COST-EFFECTIVE TOROID

AMVECO's state-of-the-art manufacturing processes have made the use of toroids cost-effective across a broad spectrum of applications.

Toroids are routinely replacing laminated frame types in the most demanding industry applications, including: medical, telecommunications, instrumentation, test equipment, lighting and signs, process control, office and computer peripherals, audio and broadcast, as well as many others.

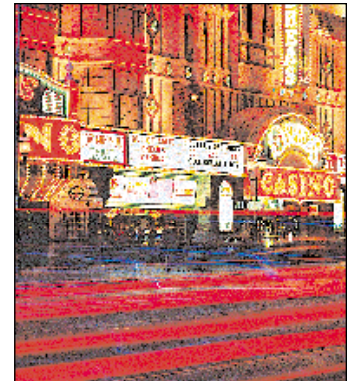
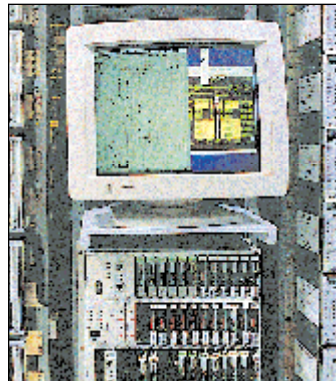
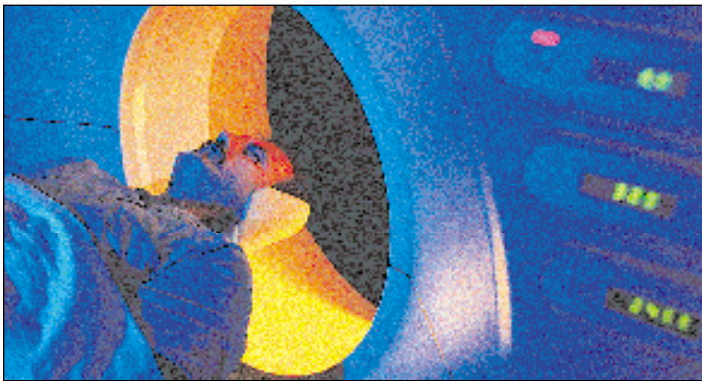

HIGHER LEVEL ASSEMBLY

AMVECO's higher level assembly services deliver products one step closer to production. This approach can save you time and money while AMVECO's in-house tooling and testing capabilities ensure prompt delivery of high quality products ready for your final assembly.

COMPLIMENTARY PRODUCTS

AMVECO also designs and produces standard and custom inductors, current transformers and auto transformers. All custom components are designed and manufactured to meet customer specifications and are also subjected to the same demanding manufacturing standards used in the production of our toroidal transformers. These complimentary products have been developed, and will continue to be developed, in response to your needs.



WE ARE HERE TO SERVE YOU

Our engineers want to be part of your power supply design group. We'll show you how you can optimize your product's appearance and performance and reduce total cost.

Since most of our products are custom designed, our work begins with a customer inquiry. Together with a customer's engineers, we determine the AC line, AC or DC load requirements and other user-specific conditions. With state-of-the-art proprietary CAD programs, our engineers quickly generate preliminary designs. Often in a matter of hours, if needed.

Our tested and proven in-house software programs enable us to simulate optimum performance characteristics from your data. All of our design proposals are accompanied by a price quotation. You can then order a prototype for your evaluation, or select from our extensive inventory of standard toroids. You incur no expense until you place an order.

AMVECO can respond quickly and effectively to meet your needs because we have experienced people to assist you at every step, from the factory to the field. Expert application and product engineers can work with you from initial development through final delivery. Our knowledgeable customer service personnel utilize fully computerized processing systems for prompt, reliable service. Our representative organizations are strategically located to meet your needs nationwide.

WEB SITE DESIGN SERVICE

To evaluate the feasibility of toroidal power transformers for specific applications, AMVECO has established an interactive web site. You need only type in user-specific transformer modeling data. The interactive program will respond with specific toroid possibilities and prompt you on how to obtain your AMVECO transformer. Our engineers will be glad to validate your design.



SAFETY STANDARDS

AMVECO proudly holds Certificates from both North American and International Safety Standard Testing Laboratories in addition to having its factory certified to ISO 9001.

Family Approvals (Recognitions) which eliminate the need to send new designs for destructive testing.

- *UL 506 General Purpose Transformers (File # E 122978)*
- *UL 1411, Audio, Radio and Television Products (File # E 115143)*
- *UL 1950 Information Technology Equipment, Electrical Business Equipment (File # E 138299)*
- *UL 544/UL 2601 Medical and Dental Equipment (File # E 138299)*
- *UL 1446, Class B, Class F and Class H Insulation Systems (File # E 123069)*
- *CSA 22.2 No. 66-1988 Specialty Transformers (File # LR 86989)*
- *CSA 22.2 No. 601.1 M90 Medical Standard for Canada (File # E 138299)*
- *IEC 601.1 (Medical Standard for International Installations)*
- *EN 60601 Medical Standard for European Installations*
- *EN 60742/EN 61558 European Safety Standard for General Purpose Transformers*

AMVECO maintains an active policy to invest in family approvals of different domestic and international safety standards in direct response to market needs and to better serve its customer base.

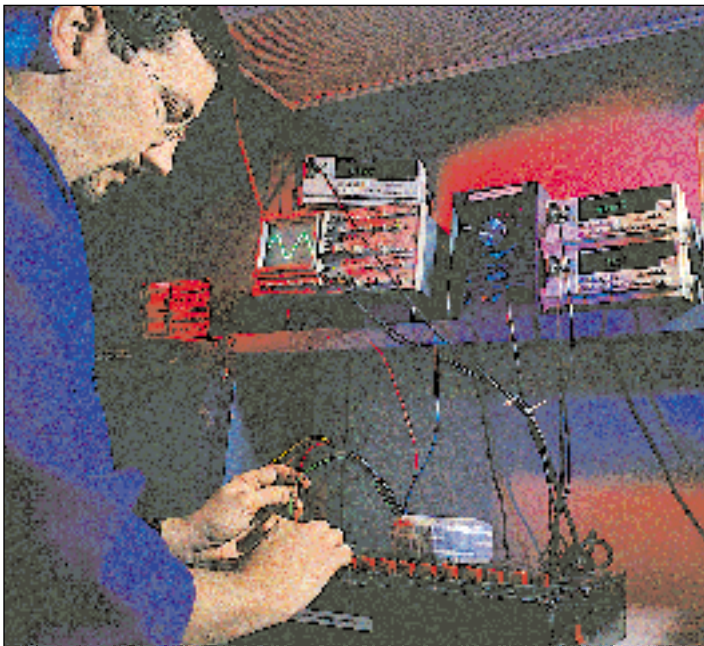

EXPERT CERTIFICATION GUIDANCE

AMVECO can also provide test data and construction documentation required by regulatory agencies. The major agencies throughout the world have already tested our standard lines and certification for most toroid applications is on hand, including UL, CSA, TUV and CE marking is an available option.

ISO 9001 CERTIFIED QUALITY SYSTEM

With ISO 9001 Certification as a cornerstone, since 1992, AMVECO's quality policy represents a never-ending process that involves the commitment of every employee. This commitment is proven every day, at every step in the manufacturing process through delivery of our products to you.



UNMATCHED QUALITY/UNPARALLELED SERVICE

Power system design engineers have come to recognize AMVECO as the leading manufacturer of custom toroidal power transformers and inductors.

Over the years since 1982, we have built a reputation for excellence by focusing on design engineering state-of-the-art production capabilities and customer support services. Our quality management system has been ISO 9001 certified since 1992.

When you select AMVECO for your power transformer needs you acquire a team of experienced professionals that offer assistance from design to delivery and beyond.

One simple fact verifies our quality claims: our customers stay with us year after year and continue to trust us with their new product needs.

In addition to Class A insulation system, Amveco offers Class B (130 °C), Class E (120 °C), Class F (155 °C) and Class H (180 °C).

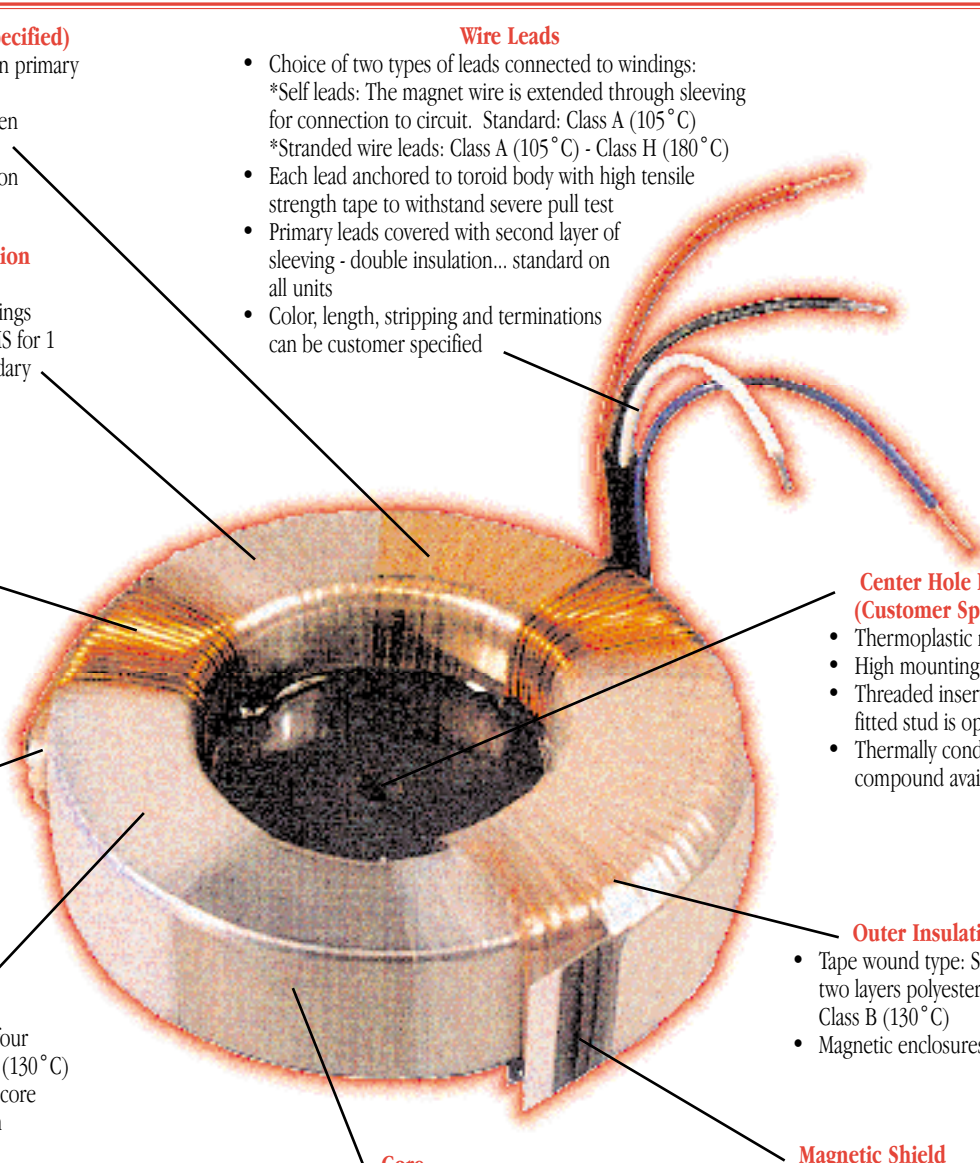

Electrostatic Shield (Customer Specified)

- Reduces capacitive coupling between primary and secondary windings
- Copper foil (2 mil) laminated between polyester film and tape
- Tightly wound over primary insulation

Wire Leads

- Choice of two types of leads connected to windings:
 - *Self leads: The magnet wire is extended through sleeving for connection to circuit. Standard: Class A (105 °C)
 - *Stranded wire leads: Class A (105 °C) - Class H (180 °C)
- Each lead anchored to toroid body with high tensile strength tape to withstand severe pull test
- Primary leads covered with second layer of sleeving - double insulation... standard on all units
- Color, length, stripping and terminations can be customer specified

Primary to Secondary Insulation

- Polyester film-Class B (130 °C)
- Four layers minimum between windings
- Meets test requirement of 4000V RMS for 1 minute between primary and secondary

Windings

- Base coat of Polyester. Heavy topcoat of amide imide (200 °C)
- Wound uniformly over entire core
- Better heat dissipation
- Windings configured for minimum flux leakage
- Low voltage maintained between adjacent turns

Center Hole Potting (Customer Specified)

- Thermoplastic material
- High mounting precision
- Threaded insert or press fitted stud is optional
- Thermally conductive compound available

Thermal Protection (Customer Specified)

- Usually in primary circuit
- Normally closed-auto reset opens at high temperature
- One-shot fuse also available
- UL, CSA, VDE listed components

Outer Insulation

- Tape wound type: Standard two layers polyester film Class B (130 °C)
- Magnetic enclosures optional

Core Insulation

- All cores: 100% surface coverage of four layers of 2 mil polyester film Class B (130 °C)
- Protects, insulates and cushions the core from windings and reduces vibration

Magnetic Shield (Customer Specified)

- Multiple layers of grain oriented silicon steel tightly wound around the toroid's circumference
- Fixed in place by outer insulation

Core

- Cores are manufactured and annealed in-house, under controlled conditions
- Continuous tightly wound grain oriented silicon steel... no airgaps, no mechanical noise
- Lathed radial corners... compact design, most efficient use of materials
- No core caps necessary

AMVECO's unique method to protect the wire from the sharp corners of the core during the winding operation permits unlimited choice of core size to best meet the customer's available space. Other methods include use of plastic end caps or dipping the core in epoxy. Amveco can offer these methods too, if preferred by the customer.

The first toroid patent dates back to 1884. However, it's only during the past thirty years, as AMVECO and its predecessors developed practical manufacturing techniques, that large numbers of toroids have been applied in wide varieties of electrical and electronic products. The usage of toroids has grown rapidly because of the many features that permit new and innovative product designs. The following is a discussion of various aspects of toroidal transformer technology that will be useful to design engineers contemplating their application in new or existing equipment.

CUSTOM DESIGNS FOR OEM APPLICATIONS

Unlike their E-I counterparts, toroids lend themselves to custom applications because toroidal designs don't require the use of special costly tools, such as stamping dies (required for special lamination forms).

Upwards of 95% of Amveco's volume is consumed by custom products.

SMALL SIZE THROUGH REDUCED CORE AND COPPER LOSSES

From Faraday's equation for induced voltage in a transformer winding, we derive the following practical equation:

$$E_{rms} = 4.44 \times f \times N \times B \times A \times 10^{-8}$$

E_{rms} = Induced voltage in winding
 f = Frequency (Hz)
 N = Winding turns
 B = Flux density
 A = Core cross section (cm²)

Increasing the working flux density will permit a lower number of turns and/or a smaller cross sectional core area. Experience has shown that working flux densities of 16k to 18k Gauss can be used in toroids.

Working flux densities of 12k to 14k Gauss are the practical limits for typical laminated cores with airgaps. Thus, selecting a toroid may directly reduce core material (weight) or winding turns (copper losses).

FLEXIBLE DIMENSIONS

As long as the cross sectional area of the toroidal core is held constant, the height and diameter may be varied to meet the designer's requirement. The functional optimum diameter-to-height ratio is 2:1. For modern equipment design emphasizing a low profile, a 3:1 ratio, wider diameter and lower height may be more suitable. In cases where a smaller "footprint" is desired, a 1.5:1 ratio should be considered (narrower diameter, higher profile).

The only restrictions are those of the mechanical considerations of insulation and winding machinery. A minimum center hole must be maintained in order to permit the insertion of the winding machine shuttle into the center hole of the core.

REDUCED SIZE REDUCTION THROUGH DUTY CYCLE

A significant reduction in transformer size and weight may be realized in many cases where the transformer is loaded intermittently. In such cases, the load is energized for a small portion of the period. If the loaded period is much shorter than the overall thermal time constant of the transformer, the following equation applies:

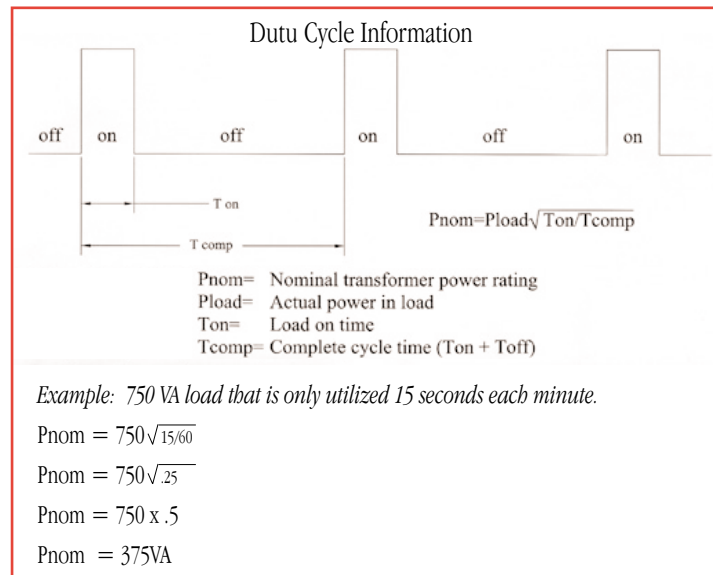

TEMPERATURE RISE CONSIDERATIONS

Total losses for the transformer, including winding losses and core loss at a given flux level, may be calculated from design data and data furnished by steel suppliers.

At AMVECO, our toroids are ordinarily designed to render a 60°C to 65°C temperature rise. The graph below illustrates the rise in transformer temperature as the actual power approaches and then exceeds the transformer's nominal power rating. Careful consideration must be given to the expected load conditions.

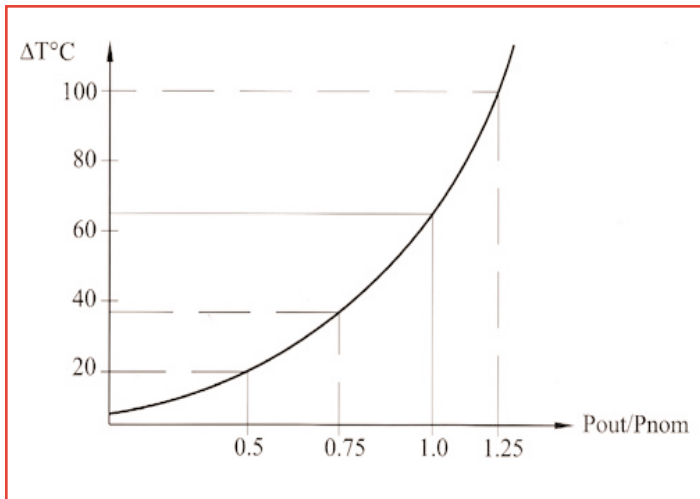

STRAY FIELD DATA

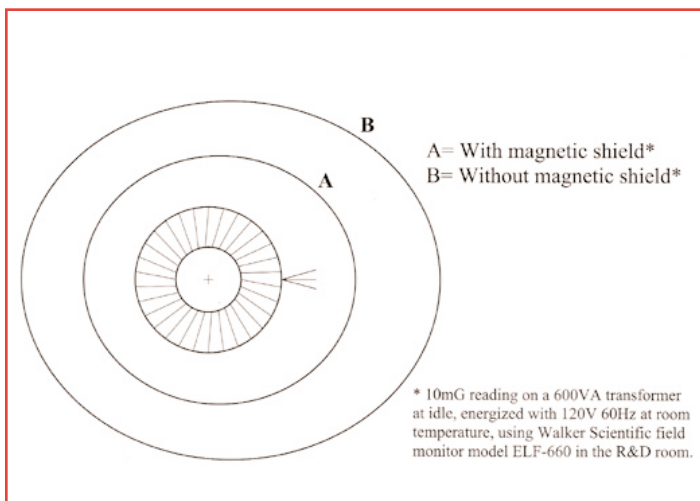

REGULATION

The load regulation of toroidal power transformers is expressed by the following equation:

$$\%Reg = [(E_{oc} - E_n) / E_{oc}] \times 100$$

$$E_n = \text{Full load voltage}$$

$$E_{oc} = \text{No-Load}$$

Regulation may be improved by using larger diameter wire in the windings or a larger core. This technique is accompanied by a slight increase in size and cost.

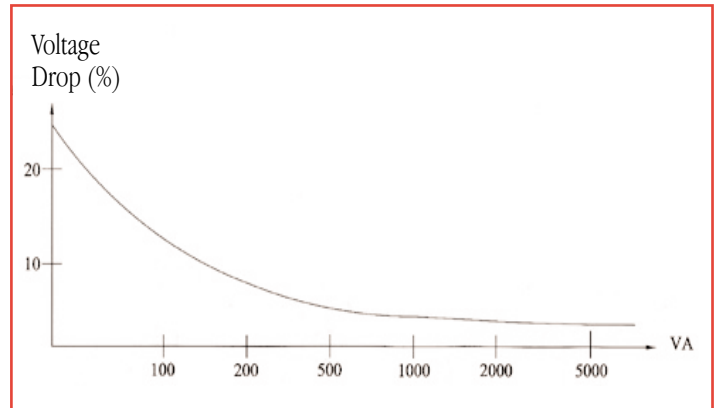

TOROID EFFICIENCY

The following graph illustrates the effect of increasing load on the efficiency of a toroid for various power ratings.

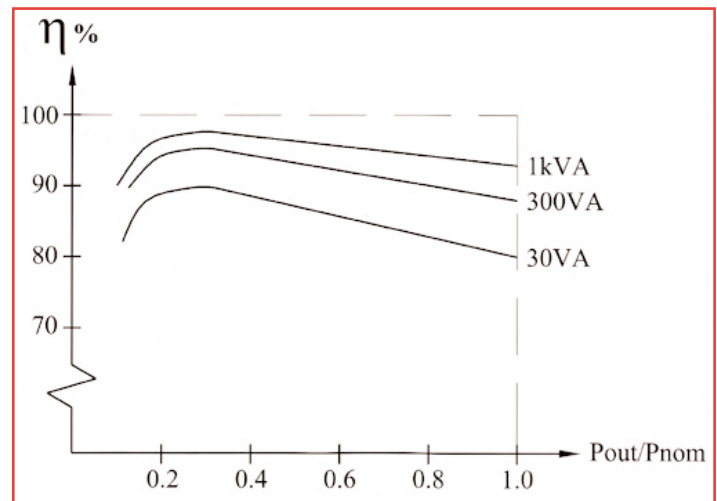

LINE FREQUENCY

Our standard transformers are designed to operate in 50 or 60Hz circuits. Upon request, we furnish toroids with thinner laminations for operation at frequencies to 2kHz. For even higher frequencies, cores are chosen from such composite materials as ferrite or powdered metal.

APPLYING TOROIDS TO RECTIFIER POWER SUPPLIES

When used in rectifier circuits, the advantages of toroids may be optimized if consideration is given to how they are applied. AC current in the transformer's secondary is not only influenced by the DC load current, but, just as important, by the circuit configuration. Common circuit configurations are shown as follows:

Full Wave Bridge (FWB)

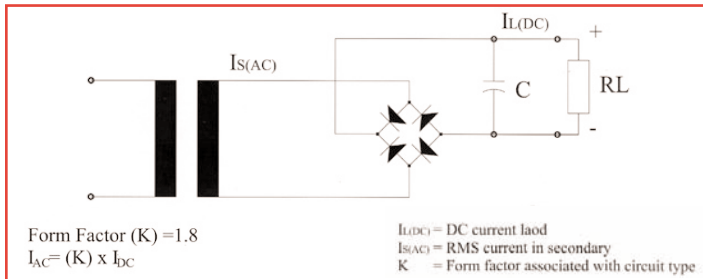

Full Wave Center Tap (FWCT)

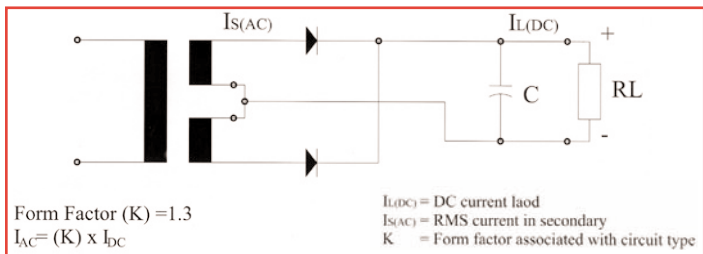

Full Wave Center Tap (FWCT) With Choke Input

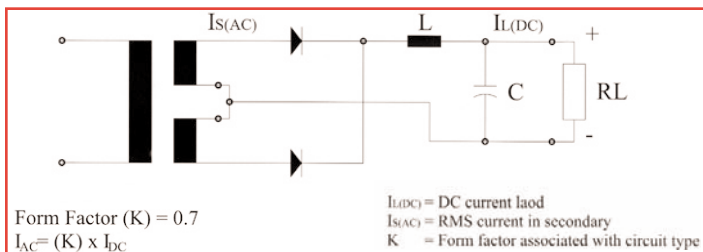

Full Wave Bridge Tap (FWCT) With Dual Outputs

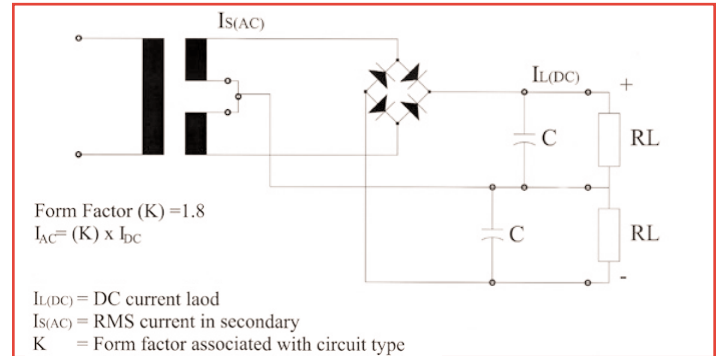

FORM FACTOR (K)

- $I_{L(DC)}$ = DC current load
- $I_{S(AC)}$ = RMS current in secondary = $K \times I_{L(DC)}$
- K = Form factor associated with circuit type

The "Form Factor" (K) is related to the rectifier circuit configuration and the wave form of the current in the secondary.

$$I_{AC} = K \times I_{DC}$$

Typical form factor (K) values at capacitor input filter:

Rectifier Type	Form Factor (K)
FWB	1.8
FWCT	1.3
FWCT with choke input	0.7
FWCT with dual outputs	1.8

AMVECO employs computer aided design techniques to optimize the toroidal transformer parameters. Our computer program takes into account the influence of the circuit Form Factor (K) as shown above. When preparing specifications for toroids, it is important that the capacitor value and the voltage drop across the regulator (if any) is furnished.

In some high current applications, a choke input filter will compound savings because inductors yield a lower Form Factor (K). In these circuits, the size of the transformer and the total capacitance are both reduced.

Weight Comparison: Toroid vs. E-I Transformer

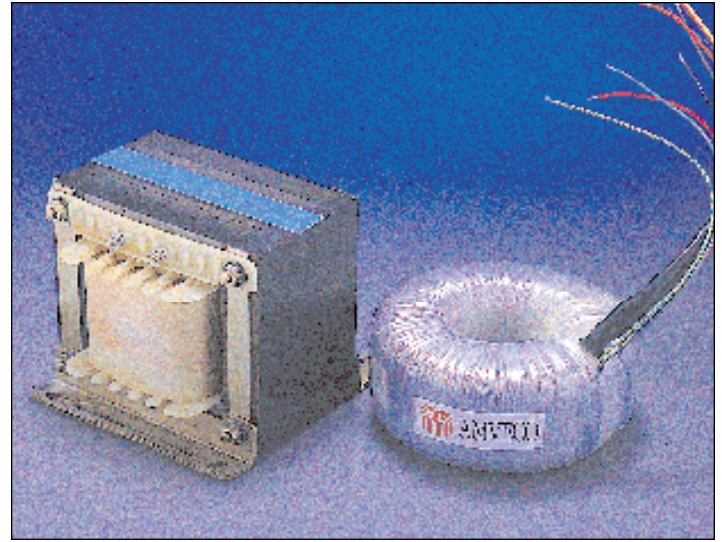
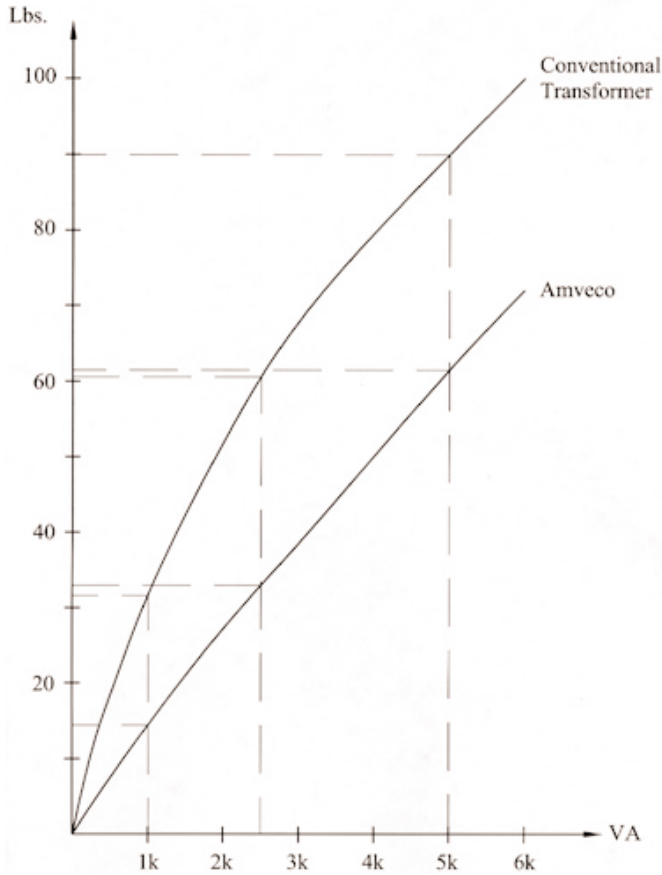

Overall Comparison of 250 VA E/I-Core AMVECO Isolation Transformer vs. 250 VA E-I Core Isolation Transformer

Feature	E-I Core Transformer	AMVECO
Height	4.7" (119 mm)	2.2" (56 mm)
Width	3.9" (99 mm)	4.5" (114 mm)
Depth	4.3" (109 mm)	4.5" (114 mm)
Volume	78.8 sq. in. (508.4 cm ²)	35.0 sq. in. (225.8 cm ²)
Dimensional Adaptability	Limited by available dies	All dimensions can be adjusted
Weight	10 lb. (4.5 kg)	5 lb. (2.3 kg)
Mounting Requirements	Four corner bolts	Single bolt through center
Magnetizing Current	10.0 W	1.5 W
No-Load Loss	20.5 mW	0.6 mW
Continuity of Magnetic Path	50% of grain perpendicular	100% parallel grain orientation
Air Gaps	Approximately 180 (60 laminating x 3)	None
Magnetic Properties of Core	Affected by clamping, welding, banding, etc.	Optimized prior to winding and remain stable
Coupling Factor	Limited by bobbin width and layers of windings	Maximized by even winding distribution & close proximity to core
Long-term Reliability	Thermal cycling and vibration steadily degrade performance	Lifetime Warranty



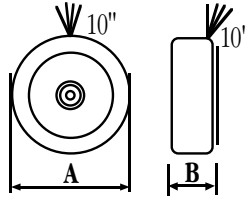

DISK MOUNTING

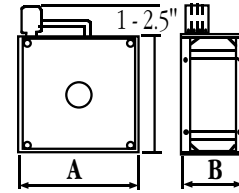

FLANGE MOUNTING

Nominal Power (VA)	Copper Losses ⁽²⁾ (W)	Core Losses (W)	Dimensions			Dimensions		
			A inch (mm)	B inch (mm)	Weight lb (kg)	A inch (mm)	B inch (mm)	Weight lb (kg)
50-60 Hz	60Hz							
15	18	3.0	2.5 (64)	1.3 (33)	0.7 (0.3)			
30	36	5.8	3.0 (76)	1.5 (38)	1.1 (0.5)	N/A	N/A	N/A
50	60	8.6	3.2 (81)	1.4 (36)	1.6 (0.7)			
80	95	12.0	3.9 (99)	1.5 (38)	2.2 (1.0)			
120	145	16.0	3.9 (99)	1.9 (48)	3.0 (1.4)			
160	190	19.0	4.5 (114)	1.7 (43)	3.8 (1.7)	N/A	N/A	N/A
225	270	20.0	4.5 (114)	2.0 (51)	4.9 (2.2)			
300	360	22.0	4.6 (117)	2.6 (66)	5.7 (2.6)			
400	480	27.0	5.4 (137)	2.0 (51)	6.5 (3.0)	5.7 (145)	3.3 (84)	8.1 (3.7)
500	600	31.0	5.4 (137)	2.4 (61)	8.0 (3.6)	5.7 (145)	3.7 (94)	9.6 (4.4)
625	750	36.0	5.5 (140)	3.2 (81)	9.5 (4.3)	5.7 (145)	4.2 (107)	11.1 (5.0)
800	960	45.0	6.4 (163)	2.7 (69)	12.3 (5.6)	6.9 (175)	3.9 (99)	14.6 (6.6)
990	1200	45.0	6.4 (163)	3.0 (76)	16.0 (7.3)	6.9 (175)	4.3 (109)	18.3 (8.3)
1100	1320	45.0	6.4 (163)	3.3 (84)	17.0 (7.7)	6.9 (175)	4.6 (117)	19.3 (8.8)
1300	1560	60.0	8.0 (203)	2.6 (66)	20.0 (9.1)	8.3 (211)	3.9 (99)	23.0 (10.4)
1600	1920	62.0	8.0 (203)	3.0 (76)	23.0 (10.4)	8.3 (211)	4.3 (109)	26.0 (11.8)
1900	2280	65.0	8.0 (203)	3.4 (86)	26.0 (11.8)	8.3 (211)	4.7 (119)	29.0 (13.2)
2200	2640	73.0	8.9 (226)	3.3 (84)	29.0 (13.2)	9.3 (236)	5.1 (130)	33.5 (15.2)
2500	3000	79.0	8.9 (226)	3.5 (89)	33.0 (15.0)	9.3 (236)	5.3 (135)	37.5 (17.0)
2800	3360	89.0	9.8 (249)	3.1 (79)	35.0 (15.9)	10.2 (259)	4.9 (124)	41.0 (18.6)
3200	3840	91.0	9.8 (249)	3.5 (89)	42.0 (19.1)	10.2 (259)	5.3 (135)	48.0 (21.8)
3700	4440	93.0	9.8 (249)	3.9 (99)	46.0 (20.9)	10.2 (259)	5.7 (145)	52.0 (23.6)
4400	5280	112.0	11.2 (284)	4.3 (109)	53.0 (24.0)	11.6 (295)	6.1 (155)	60.0 (27.2)
5000	6000	112.0	11.2 (284)	4.7 (119)	62.0 (28.1)	11.6 (295)	6.5 (165)	69.0 (31.3)
6300	7560	130.0	12.4 (315)	4.7 (119)	76.0 (34.5)	13.8 (351)	6.5 (165)	89.0 (40.4)
8000	9600	140.0	13.4 (340)	4.7 (119)	88.0 (39.9)	13.8 (351)	6.5 (165)	101.0 (45.8)
10000	12000	140.0	13.4 (340)	5.9 (150)	120.0 (54.4)	13.8 (351)	7.7 (196)	133.0 (60.3)

The values given are typical values. (2) Copper losses at 25°C ambient temperature and full load.

Over 95% of our sales are custom designs. Because they require no elaborate production tools and are individually wound, toroidal transformers are particularly well suited to custom designs.

Take advantage of our custom design service at no obligation.

Our interactive computer design capabilities enable us to optimize design's for either AC or DC loads.

- **Quick response to Requests for Quotations**
- **Rapid delivery of prototypes**
- **Pre-certified by electrical safety agencies: UL and CSA**
- **Variety of mounting arrangements**
- **Lifetime Warranty**

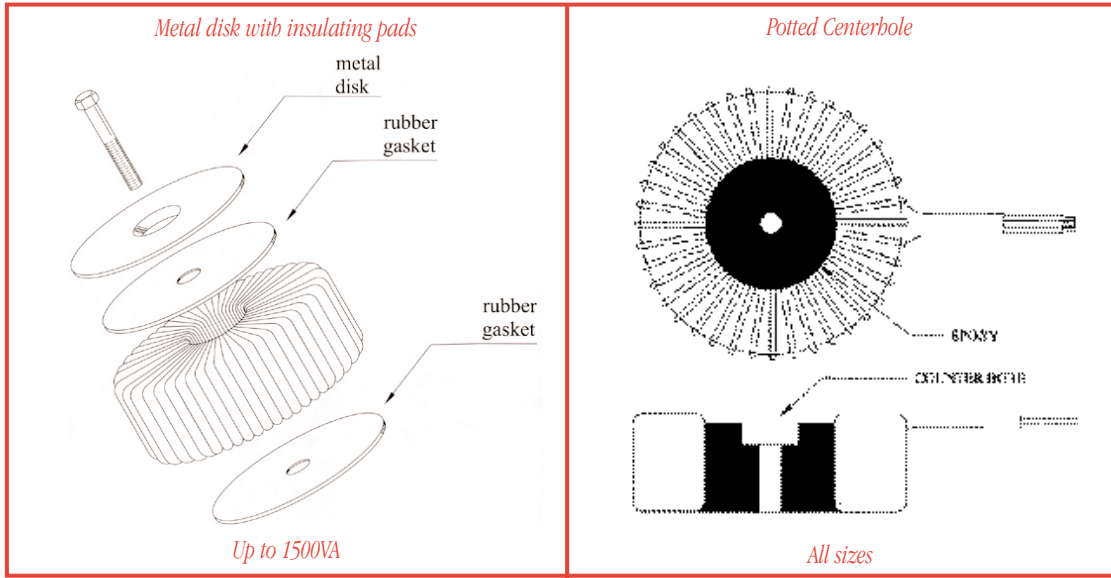

DIMENSIONS OF METAL MOUNTING DISK AND INSULATING PAD				
Power Range VA	OD inch (mm)	Hole inch (mm)	Thickness inch (mm)	Recom. Hardware
20	1.7 (45)	0.18 (4.5)	0.04 (1)	#8
40-60	2.4 (60)	0.20 (5.2)	0.04 (1)	#10
100-150	2.8 (70)	0.26 (6.6)	0.04 (1)	1/4"
200-350	3.5 (90)	0.26 (6.6)	0.05 (1.3)	1/4"
425-800	4.4 (110)	0.26 (6.6)	0.06 (1.5)	1/4"
800-1200	5.2 (130)	0.33 (8.4)	0.07 (1.7)	5/16"
1200-1500	5.6 (145)	0.41 (10.3)	0.07 (1.7)	3/8"

