

Synchro to Digital Converters

SDC1602/1604/1786 SERIES

FEATURES

Tracking Rates Up to 2880°/sec (8rps)
 Accuracies Up to ±1 minute of arc
 Resolutions of 10, 14 or 16 bits for 360°
 TTL/DTL Compatible
 MIL Spec/Hi Rel Versions

APPLICATIONS

Airframe Data Processing
 Position Monitoring
 Navigational Computation

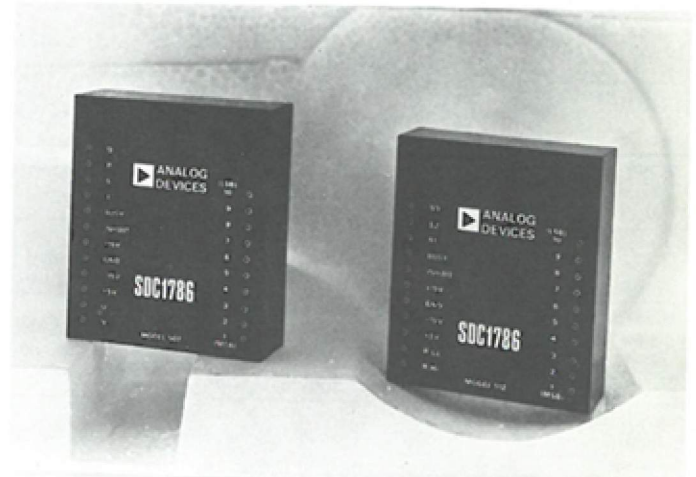

GENERAL DESCRIPTION

The "SDC" series converters are continuous tracking, type 2 servo loop, synchro or resolver to digital converters intended for military and industrial control applications.

The Synchro to Digital Converters (SDCs) work from either 3 wire synchro plus reference input signals or resolver plus reference input signals giving binary angular output data. The inputs are usually derived from remote synchros or resolvers but may be derived from electrically simulated resolvers or synchros i.e., Digital to Synchro converters (see our other product literature which describes these units).

Key to the small size and high reliability of the units is extensive use of monolithic analog switches, linear integrated circuits, MSI logic functions and thin film resistor networks.

Units have been qualified to extreme climatic, shock and vibration conditions taken from U.S. and U.K. Military and Civil Aviation Specifications. Specials are available, built with hi-rel components.

ORDERING GUIDE

1. Specify the basic model number per the following table. 60Hz versions of the 10 and 14 bit units and 400Hz or 60Hz versions of the 16 bit units require separate transformer modules.

# of Bits	Temp. Range (X)	Freq. (Y)	Converter	Transformers
16	0 to +70°C	400Hz	SDC1604507	STM163251Z
16	-55°C to +85°C	400Hz	SDC1604707	STM163271Z
16	0 to +70°C	60Hz	SDC1604507	STM167252Z
16	-55°C to +85°C	60Hz	SDC1604707	STM167272Z
14	0 to +70°C	400Hz	SDC160251Z	Integral
14	-55°C to +105°C	400Hz	SDC160261Z	Integral
14	0 to +70°C	60Hz	SDC1602507	STM163152Z
14	-55°C to +105°C	60Hz	SDC1602607	STM163162Z
10	0 to +70°C	400Hz	SDC178651Z	Integral
10	-55°C to +105°C	400Hz	SDC178661Z	Integral
10	0 to +70°C	60Hz	SDC1786507	STM163052Z
10	-55°C to +105°C	60Hz	SDC1786607	STM163062Z

2. (Z is replaced by a number to specify synchro or resolver) input plus signal/reference voltage range.

- Z = 1 signifies synchro 11.8V L-L with 26V reference
- Z = 2 signifies synchro 90V L-L with 115V reference
- Z = 3 signifies resolver 11.8V L-L with 11.8V reference
- Z = 4 signifies resolver 26V L-L with 26V reference
- Z = 5 signifies resolver 90V L-L with 90V reference
- Z = 6 signifies resolver 115V L-L with 115V reference
- Z = 8 signifies resolver 11.8V L-L with 26V reference
- Z = 2, 5, 6 are available with either 400Hz or 60Hz units
- Z = 1, 3, 4, 8 are available only with 400Hz units

3. Resolver input devices, with Z = 3, 4, 5, 6 or 8, are identified as RDC1602513, RTM1630625 and the like. An R replaces the S as the first letter in the part number.

SPECIFICATIONS (typical @ +25°C and ±15V dc unless otherwise noted)

MODELS ¹	400Hz SDC178651Z 400Hz SDC178661Z 60Hz SDC1786507 plus STM163052Z 60Hz SDC1786607 plus STM163062Z	400Hz SDC160251Z 400Hz SDC160261Z 60Hz SDC1602507 plus STM163152Z 60Hz SDC1602607 plus STM163162Z	SDC1604507 plus STM163251Z SDC1604707 plus STM163271Z SDC1604507 plus STM167252Z SDC1604707 plus STM167272Z
ACCURACY ² (max)	±30 arc-minutes	±4 arc-minutes	±1 arc-minute ³
RESOLUTION	10 bits (1 LSB = 21 arc-minutes)	14 bits (1 LSB = 1.3 arc-minutes)	16 bits (1 LSB = 20 arc-seconds)
OUTPUT (in parallel)	10 bits natural binary angle	14 bits natural binary angle	16 bits natural binary angle
SIGNAL VOLTAGES (Line-to-Line)			
Low Level	Synchro 11.8V rms L-L Resolver 11.8V rms L-L	• •	• •
High Level	Resolver 26.0V rms L-L Synchro 90.0V rms L-L Resolver 90.0V rms L-L Resolver 115.0V rms L-L	• • • •	• • • •
SIGNAL IMPEDANCE			
Low Level	20k ohms L-L. Balanced	•	•
High Level	200k ohms L-L. Balanced	•	•
REFERENCE VOLTAGE			
Low Level	26V rms 400Hz or 60Hz as appropriate	•	•
High Level	115V rms 400Hz or 60Hz as appropriate	•	•
REFERENCE IMPEDANCE			
Low Level	20k ohms	•	•
High Level	200k ohms	•	•
TRANSFORMER ISOLATION	500V dc	•	•
TRACKING RATE			
400Hz	8640°/sec	1440°/sec	360°/sec
60Hz	1260°/sec	1440°/sec	360°/sec
ACCELERATION (For 1 LSB Error)			
400Hz	34,000°/sec ²	240°/sec ²	60°/sec ²
60Hz	850°/sec ²	6°/sec ²	6°/sec ²
STEP RESPONSE (179°/step) (For 1 LSB Error)			
400Hz	200 milliseconds	300 milliseconds	400 milliseconds
POWER SUPPLIES	+15V at 35 milliamps -15V at 35 milliamps +5V at 190 milliamps	+15V at 40 milliamps -15V at 40 milliamps +5V at 240 milliamps	+15V at 60 milliamps -15V at 60 milliamps +5V at 300 milliamps
POWER DISSIPATION (max)	2.2 Watts	2.8 Watts	3.5 Watts
LOGIC OUTPUTS	DTL/TTL Compatible Fan Out: Four TTL Input Loads	•	•
CONVERTER BUSY Positive Pulse (±30% all figures)	400Hz 3.5μs 60Hz 35μs	0.8μs 5.0μs	1μs 1μs
INHIBIT	DTL/TTL Compatible Fan In One TTL Input Load	•	•
TEMP. RANGE OPERATING	0 to +70°C or -55°C to +105°C	•	0 to +70°C or -55°C to +85°C
TEMP. RANGE STORAGE (All)	-55°C to +125°C	•	•
WARM UP	1 Second to Rated Accuracy	•	•
CONVERTER MODULE SIZE	3.125" x 2.625" x 0.8"	•	•
TRANSFORMER MODULE SIZE	1.5" x 3.125" x 1.0"	•	1.5" x 3.125" x 1.0" 400Hz 2.0" x 4.5" x 1.5" 60Hz
WEIGHT	7 oz. (200gm)	•	•

NOTES:

- Nominal 60Hz units operate over range of 50 to 400Hz.
Nominal 400Hz units operate up to 1500Hz with additional 1LSB error.
- Accuracy applies over the operating temperature range and for
 - ±10% signal & reference amplitude variation
 - ±10% reference frequency variation
 - 10% signal and reference harmonic distortion
 - ±5% power supply variation
 - ±20° phase shift between reference and signals

- 16 bit accuracy is at +25°C
±1.3 arc-minutes from 0 to +70°C
±2 arc-minutes from -55°C to +85°C

Specifications subject to change without notice.

THEORY OF OPERATION

The voltages V_1 and V_2 in Figure 2 have the form:

$$V_1 = K E_0 \sin \omega t \sin \theta$$

$$V_2 = K E_0 \sin \omega t \cos \theta$$

where θ is the angular displacement of the synchro shaft. The converter operates on the equation —

$$\theta = \tan^{-1} \left(\frac{V_1}{V_2} \right)$$

computing its tangent and carrying out an analog to digital conversion on the result. To understand the conversion process assume that the digital number ϕ represents the word state of the up-down counter. This is fed to the "sine" and "cosine" multipliers which now have outputs $K E_0 \sin \omega t \sin \theta \cos \phi$ and $K E_0 \sin \omega t \cos \theta \sin \phi$. These functions are subtracted by the summing amplifier and produce an error function proportional to $\sin(\theta - \phi)$. The summing amplifier, error processor, VCO, up-down counter, and multipliers form a closed loop system which seeks to null $\sin(\theta - \phi)$.

When this is accomplished the word state of the up-down counter " ϕ " equals, within the rated accuracy of the converter, the input angle θ .

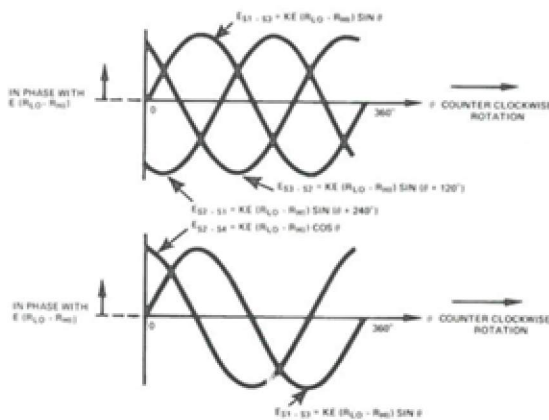

Figure 1. Angle Amplitude Waveforms

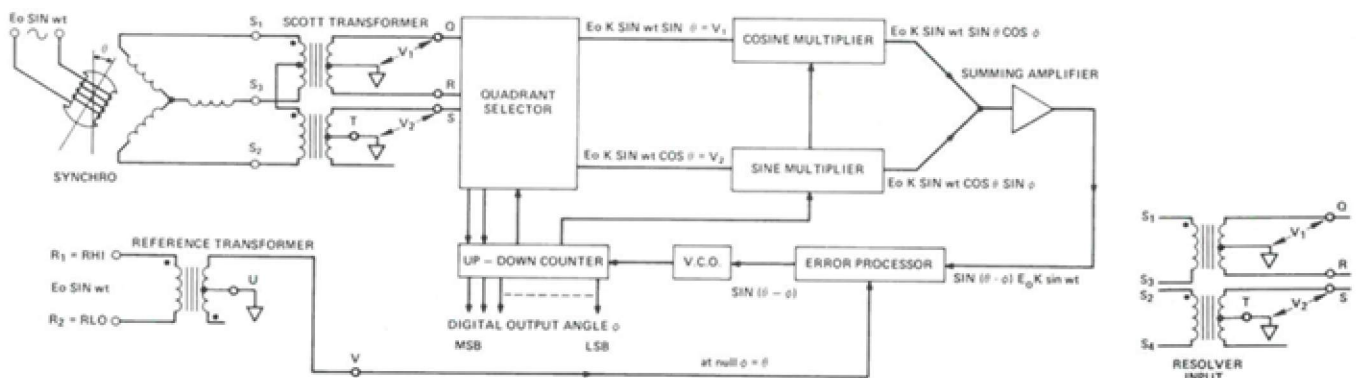

Figure 2. Block Schematic for "SDC" Series Converters

DIRECTION OF DATA ROTATION

A counter clockwise rotation of the synchro or resolver viewed from the shaft end produces an increasing output digital angle. The SDC connection conventions are marked in accordance with the waveforms of Figure 1 which show how the magnitudes of the voltages $S_1 - S_3$, $S_3 - S_2$ and $S_2 - S_1$ for the synchro and $S_2 - S_4$ and $S_1 - S_3$ for the resolver inputs vary with angle. Above the line means that the voltages vary in magnitude with θ as shown and are in phase with the reference. The voltages are 180° out in time phase for mechanical angles showing the voltages below the line.

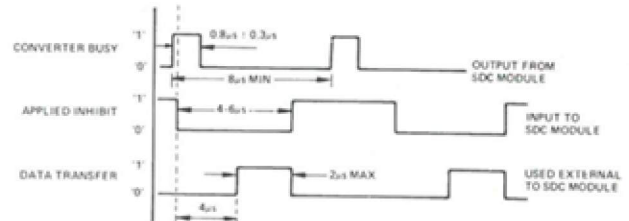

Figure 3. Data Transfer Waveforms

DATA TRANSFER (ALL MODULES)

Whenever the input angle changes, the SDC updates its output in 1LSD steps. Data can be transferred *without error* whenever the "converter busy" signal is at a Logic "0". To transfer data the "inhibit" should be set to a Logic "0" for a time of 4-6 microseconds. The converter will ignore the inhibit command during the converter busy pulse, but after this no further update will take place until the inhibit 0 is removed. The data transfer pulse should not be more than 2 microseconds long and should be applied about 4 microseconds after the leading edge of the inhibit pulse after which the inhibit 0 should be removed to permit further updating. The "converter busy" pulses correspond to the pulses from the V.C.O. which feed the up-down counter. The pulses have a maximum length of 1.1 microseconds. It follows that if the above rules are used for data transfer, no pulses will be kept in abeyance and the control loop will not be affected. See the timing waveform.

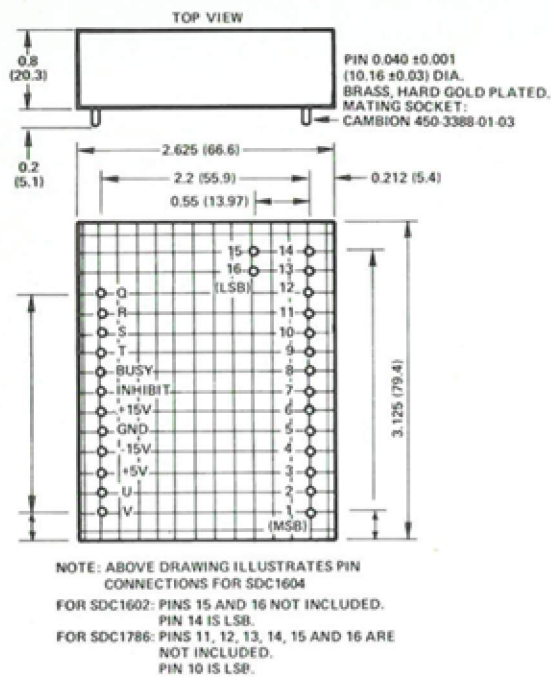

Figure 4. SDC Module (First Angle Projection). Dimensions shown in inches and (mm).

PINS SHOWN		Q	R	S	T	U	V	
SDC 1786 (400Hz)	Synchro I/P	Pin Omitted	S3	S2	S1	RLo	RHi	Transformers Internal
1602 (400Hz)	Resolver I/P	S4	S3	S2	S1	RLo	RHi	
1604 Synchro or Resolver 400Hz & 60Hz		Q	R	S	T	Pin Omitted	V	Transformers External
SDC 1786 Synchro or 1602 Resolver 60Hz		Q	R	S	T	U	V	

Table 2. Pin Markings on Modules

TRANSFORMER MODULES

When the converter modules SDC1786 and 1602 are used on 60Hz and always for the SDC1604, external transformers must be used. STM1630 and STM1631 are 60Hz transformers for 10 and 14 bit SDC. STM1632X1Z (400Hz) and STM1672X2Z (60Hz) are for the 16 bit SDC1604. All TX are encapsulated in a common size box except the STM1672X2Z.

To connect the transformer module to the SDC module the pins Q, R, S, T, U and V are connected Q → Q, R → R, etc. Pin U of the SDC1604 is omitted; do not connect to Pin U of the STM1632.

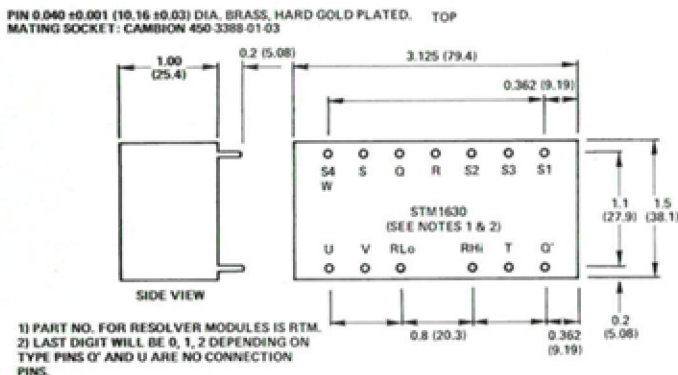
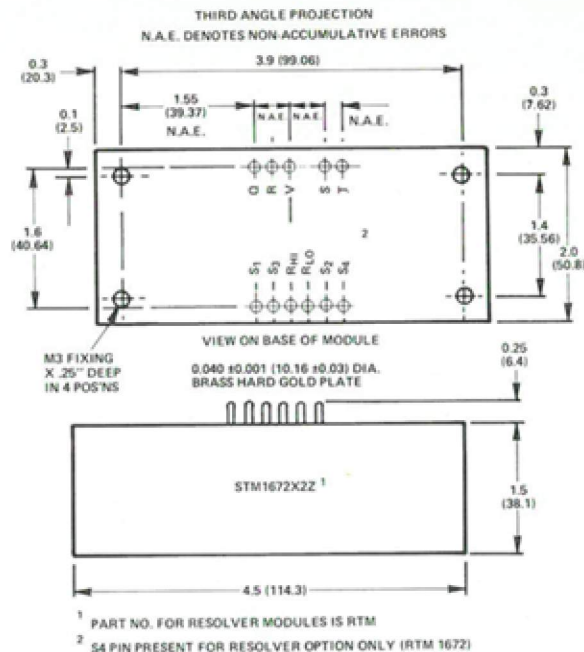

Figure 5. Encapsulated Transformer Modules (First Angle Projection). Dimensions shown in inches and (mm).



PIN NO.	FUNCTION
1	S1
2	S3
3	S2
4	Not Connected (S4 or Resolver)
5	RHi
6	RLo
7	Not Connected
8	V
9	T
10	S
11	R
12	Q

CONNECTIONS

S1, S2 and S3 are always the three wire synchro signal inputs.

S1, S2, S3 and S4 are always the four wire resolver signal inputs. S1 and S3 are sine, S2 and S4 are cosine.

RLO and RHI are always the reference inputs for either synchros or resolvers. (RLO = R2 and RHI = R1)

Pins 1 (MSB) through 16 or 14 or 10 (LSB) are always the digital outputs (most significant to least significant bits) of 16, 14 or 10 bit devices respectively.

+15V, -15V and +5V are the power supply inputs.

GND is common for the supplies and the digital outputs. Note on units with separate transformer modules pins T and U are tied to GND.

BUSY and INHIBIT are the control lines described under DATA TRANSFER.

CAUTIONS

Do not reverse power supplies.

Do not connect signal and/or reference inputs to other than S1, S2, S3, S4, RLO and RHI.

Do not connect a 400Hz unit to 60Hz.

Do not connect signals and/or references to a lower voltage rated converter (such as a 115V synchro into a 26V converter).

Misconnections per the above will damage the units (usually beyond repair) and void the warranty.